



# SR-71

---

## Blackbird

THE SR-71 RECONNAISSANCE AIRCRAFT IS A US AIR FORCE JET TYPE LONG-RANGE HIGH-ALTITUDE HIGH-SPEED STRATEGIC RECONNAISSANCE AIRCRAFT. SR-71 RECONNAISSANCE AIRCRAFT ADOPTED A LARGE NUMBER OF ADVANCED TECHNOLOGIES AT THAT TIME INCLUDING TITANIUM STRUCTURE, TURBOJET/RAMJET VARIABLE CYCLE ENGINE, WHICH STILL REMAINED PROGRESSIVENESS. THIS AIRCRAFT IS THE FIRST PRACTICAL JET AIRCRAFT TO SUCCESSFULLY BREAK THROUGH THERMAL BARRIERS, AND THERE IS NO RECORD OF ANY AIRCRAFT BEING SHOT DOWN BY ENEMY PLANES OR ANTI-AIRCRAFT MISSILES IN ACTUAL COMBAT. THE SR-71 RECONNAISSANCE AIRCRAFT BEGAN DEVELOPMENT IN 1963 AND WAS DEVELOPED AND PRODUCED BY LOCKHEED'S SKUNK FACTORY IN THE UNITED STATES. IT MADE ITS FIRST FLIGHT IN 1964 AND ENTERED SERVICE IN 1966, PRODUCING A TOTAL OF 32 AIRCRAFT.

CLASSIC  
FIGHTER  
SERIES

- ★
- ★
- ★



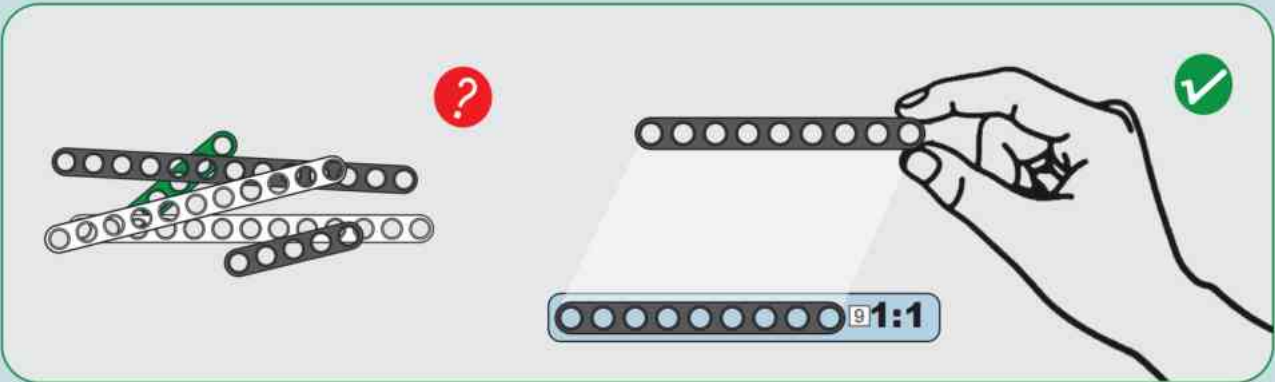
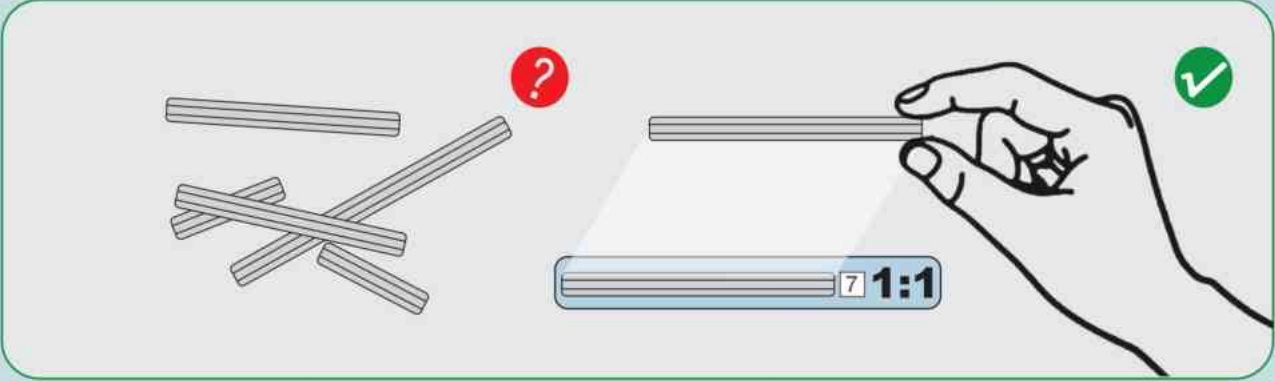

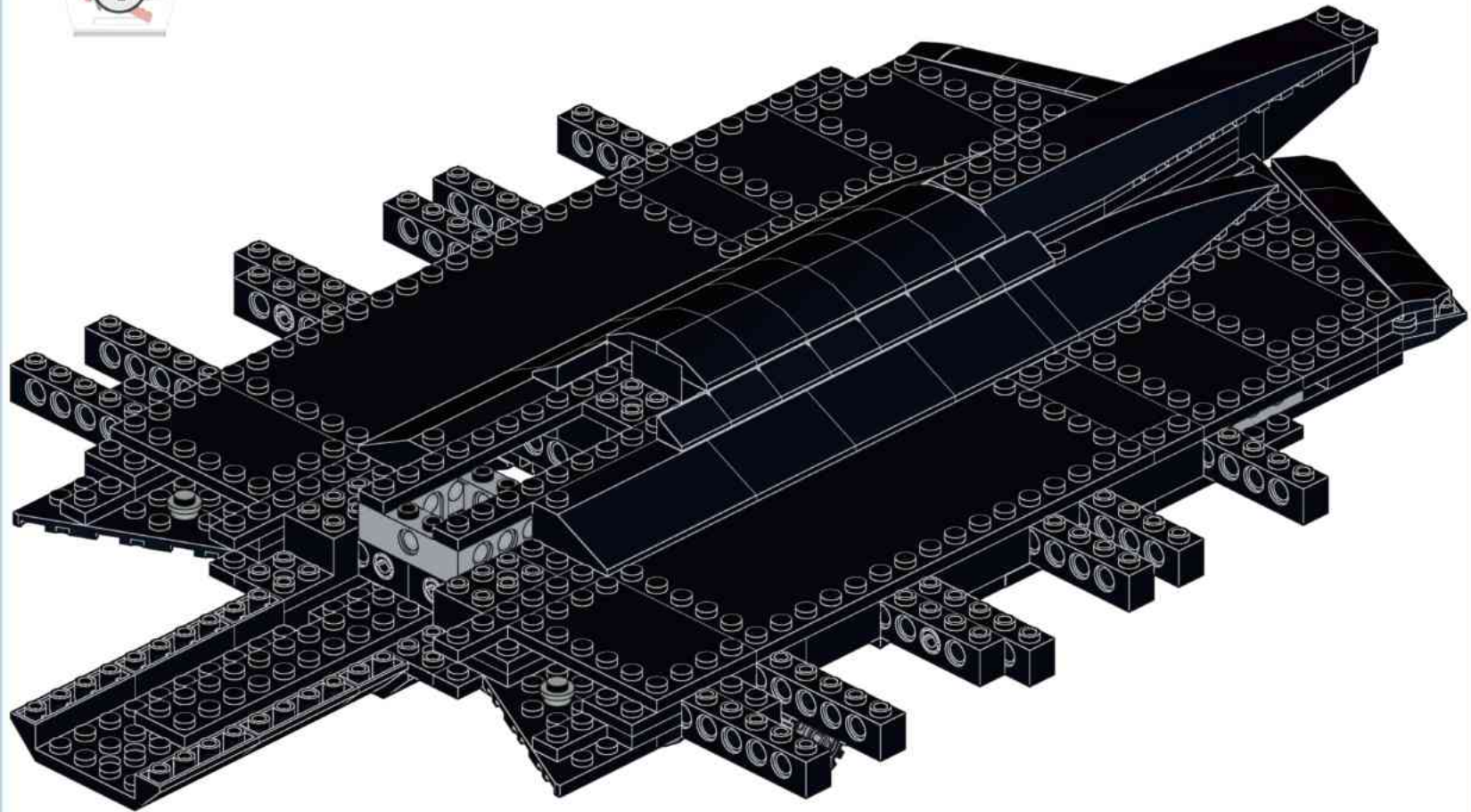

**A**

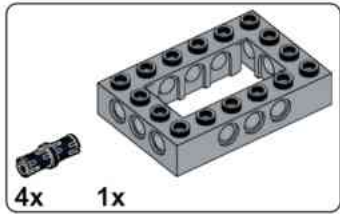

**A1**

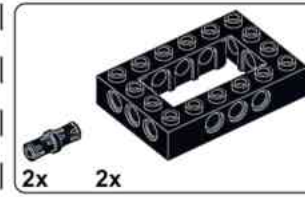

**A2**

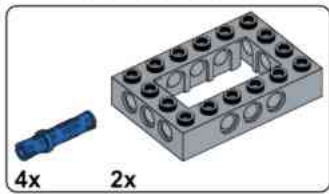
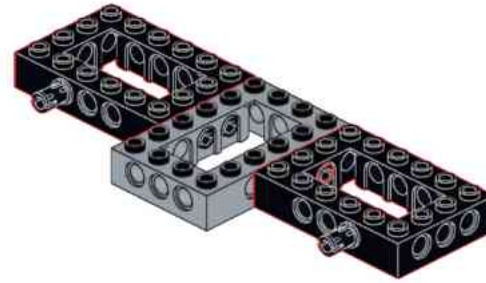

**A3**

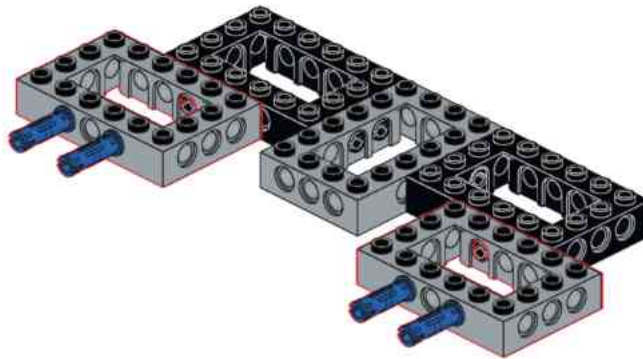



**A4**

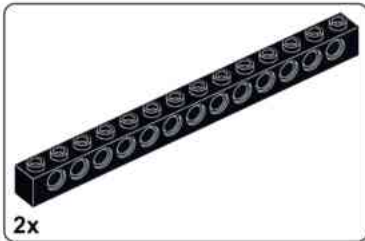
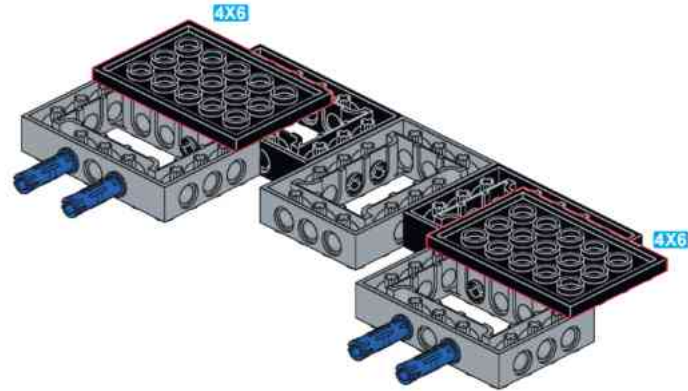

**A5**

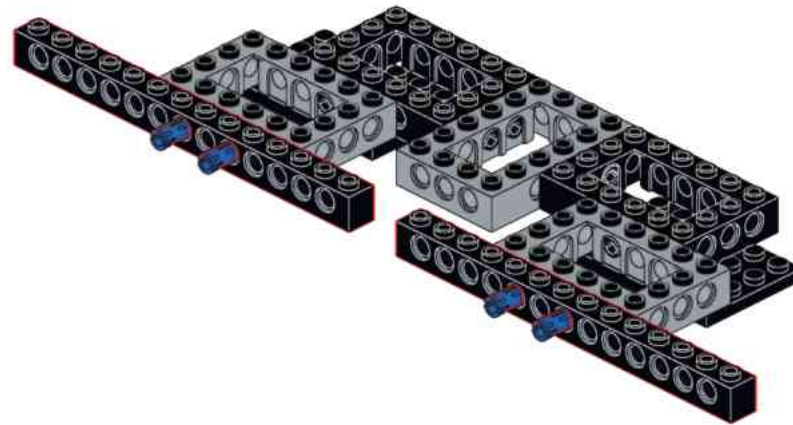

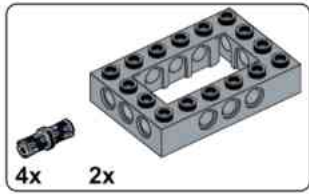

**A6**

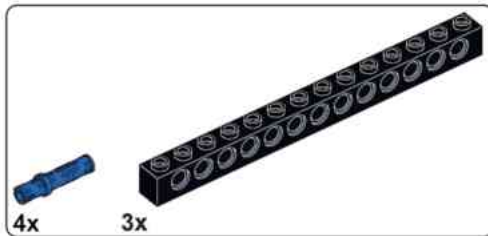
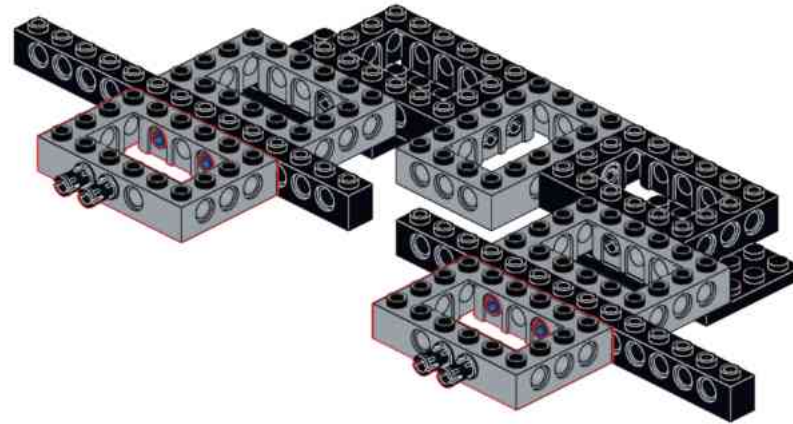

**A7**



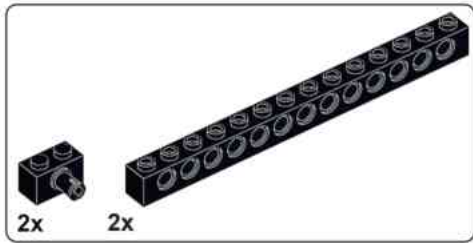

**A8**

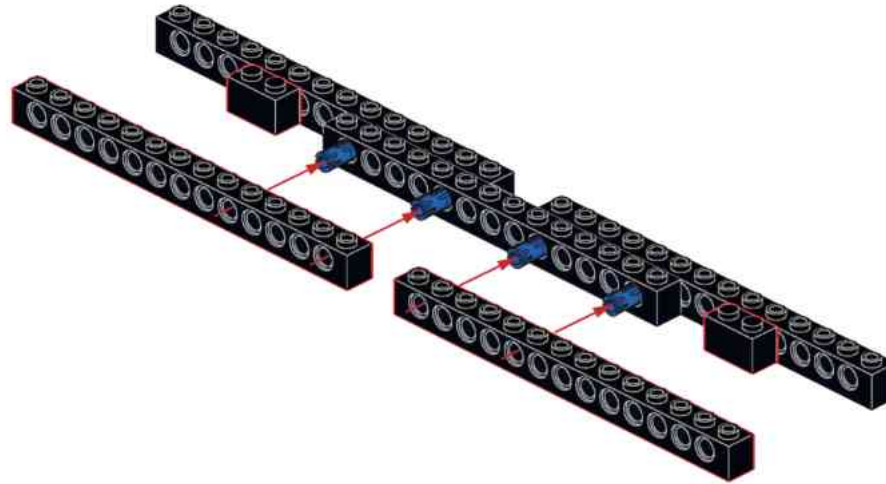

**A9**

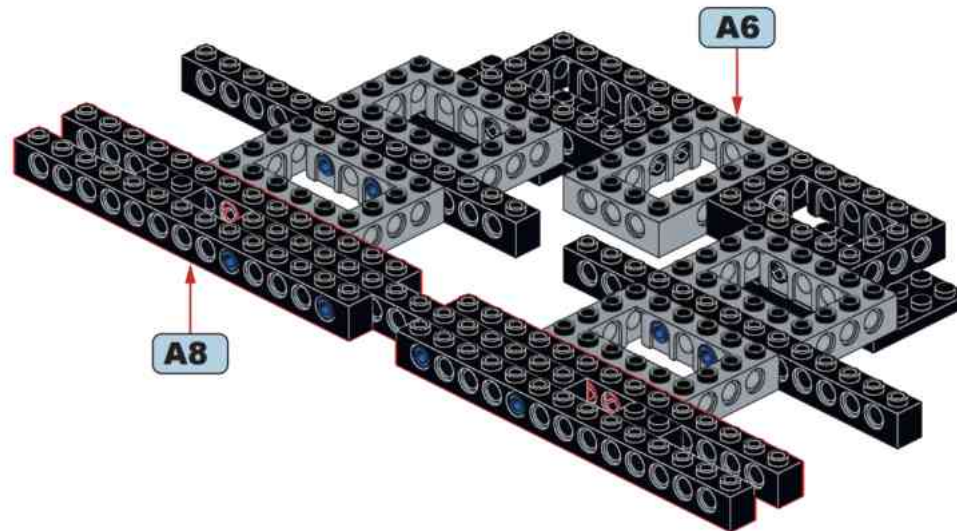

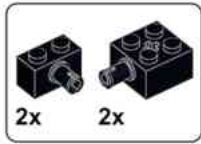

### A10



### A11

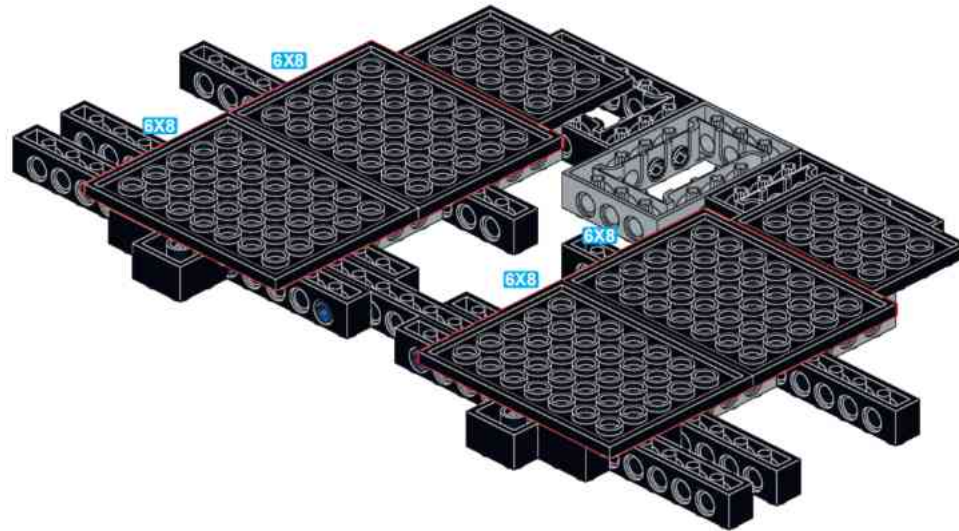

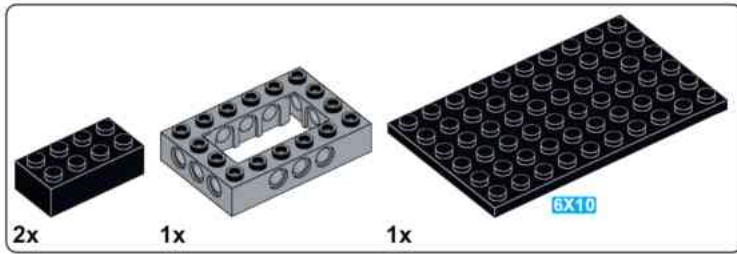

# A12

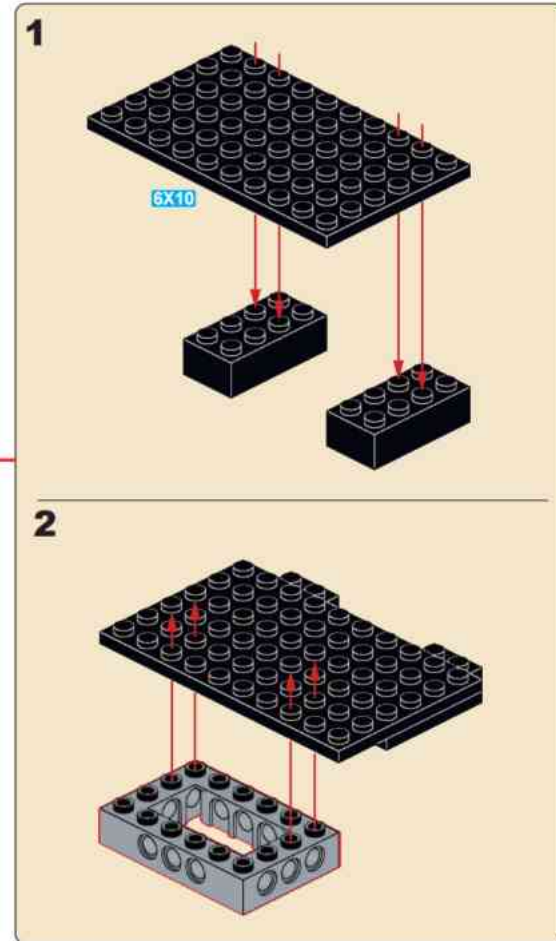
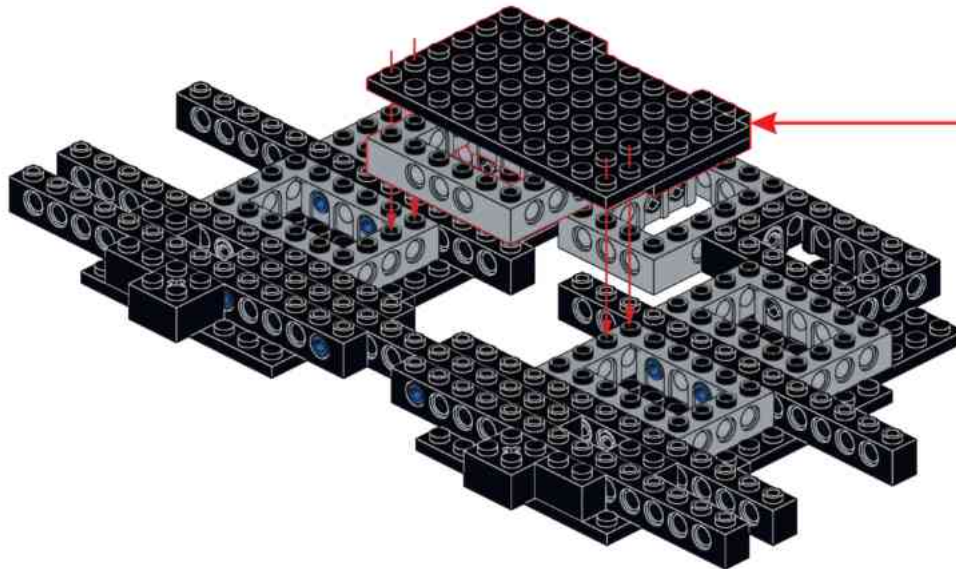

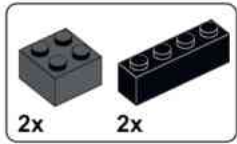

**A13**

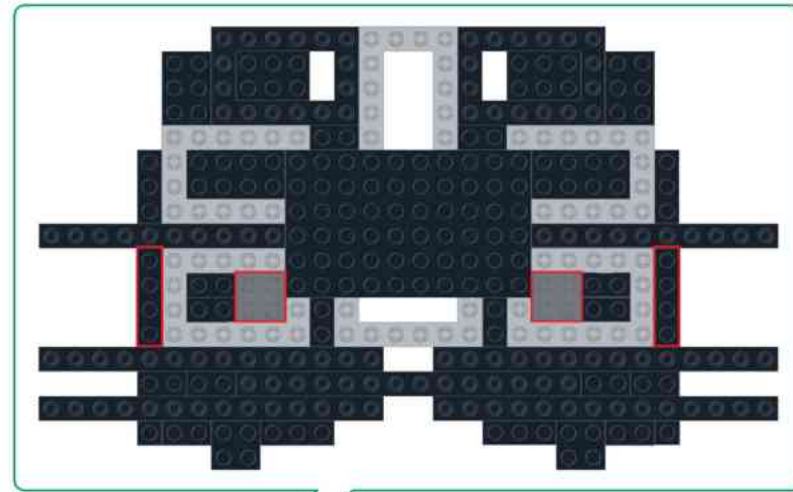

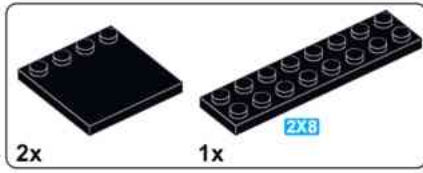

# A14



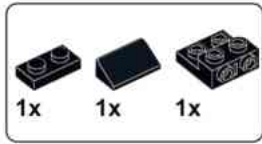

### A15

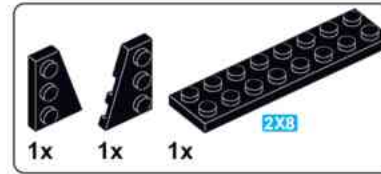
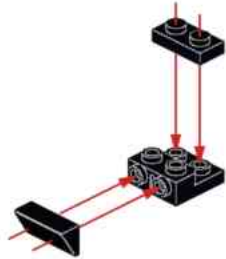

### A16

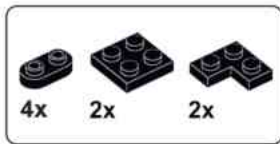
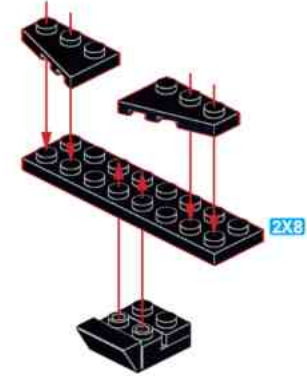

### A17

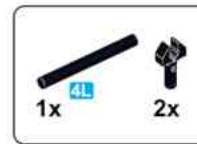
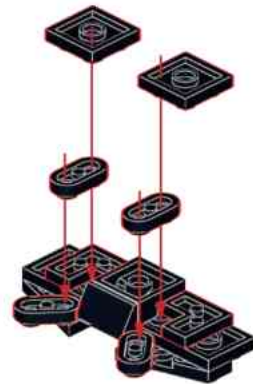

### A18



**A19**

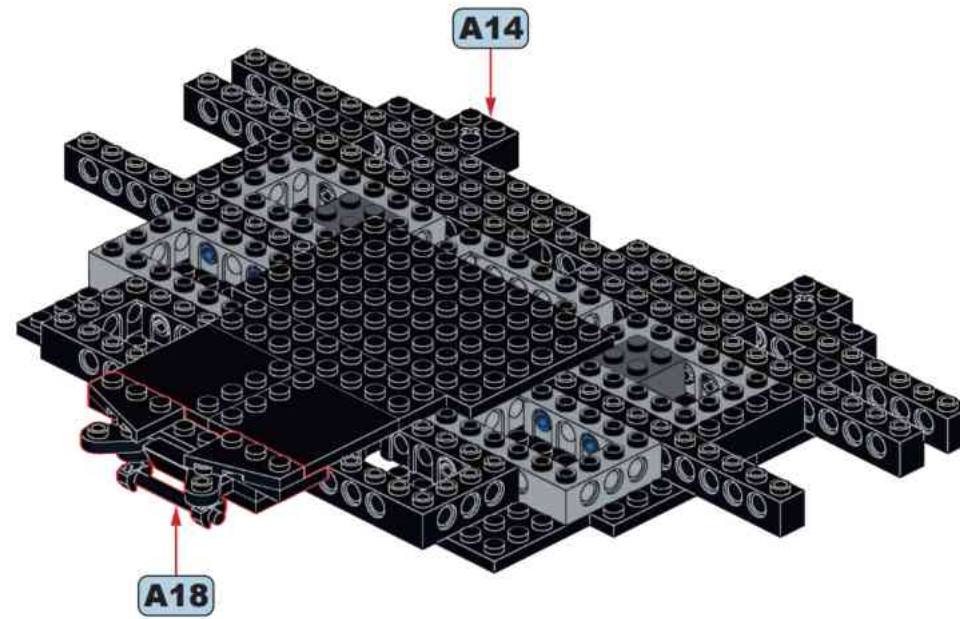

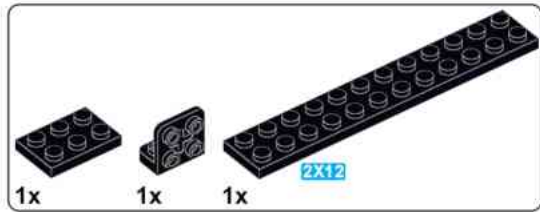

## A20

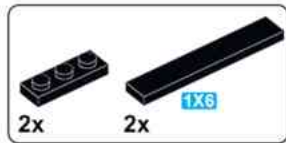
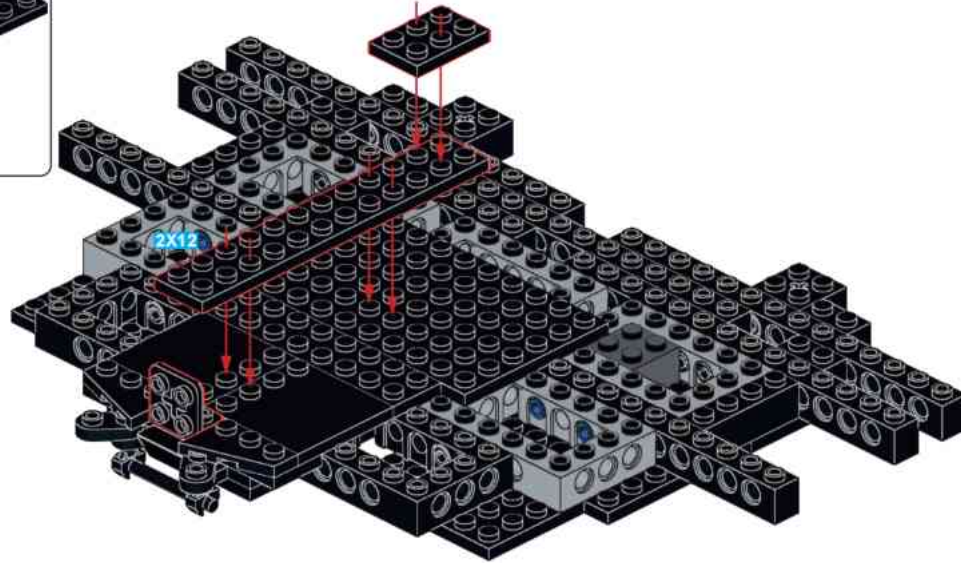

## A21





2x

**A22**

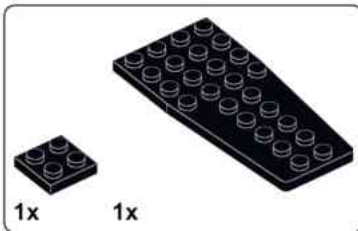
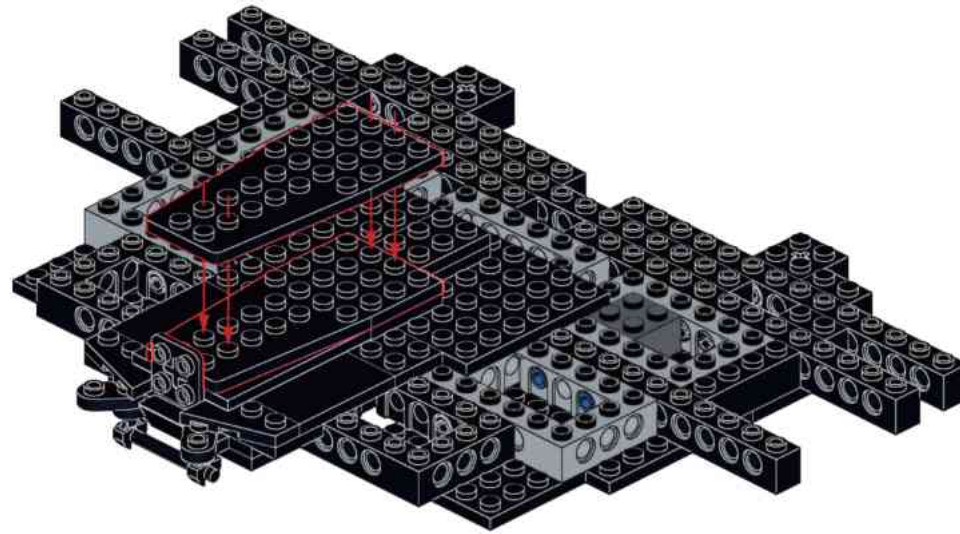

1x

1x

**A23**

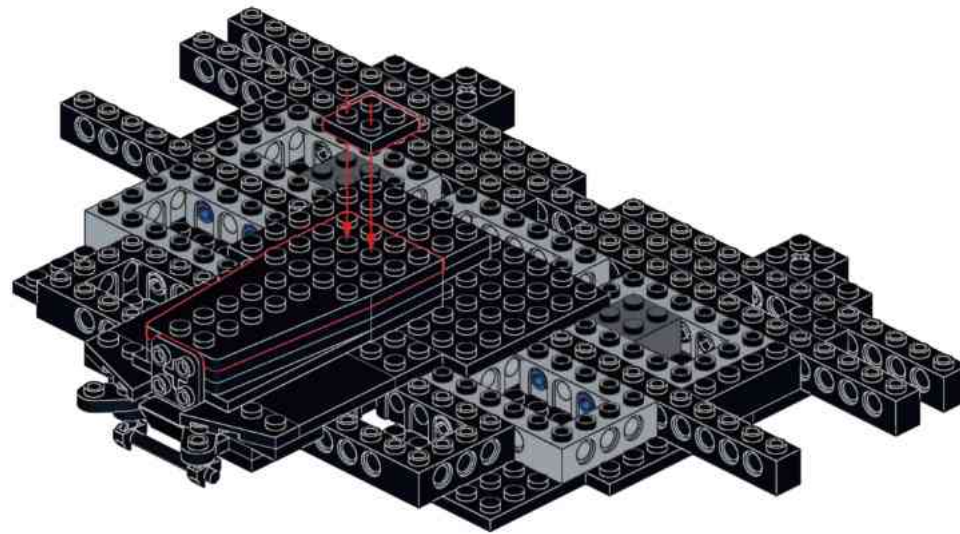

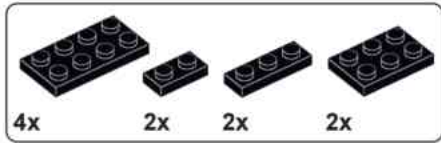

## A24

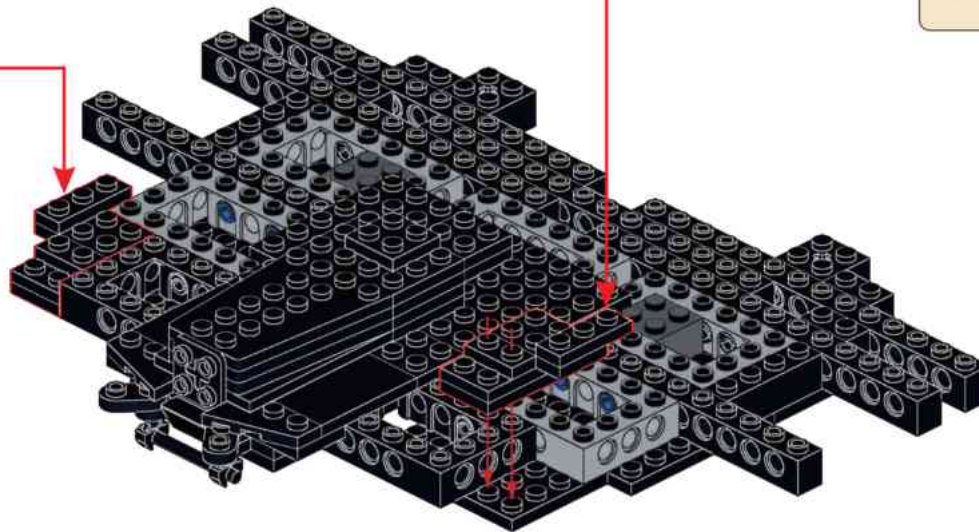
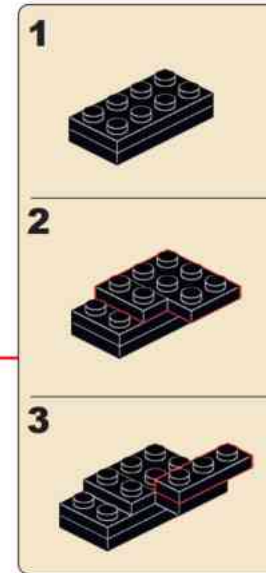
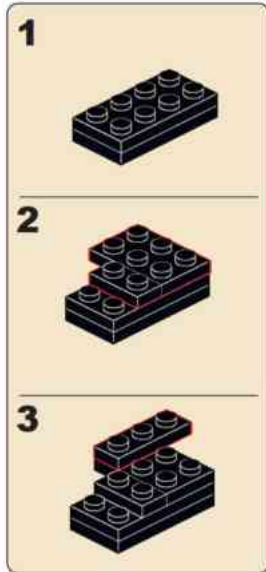

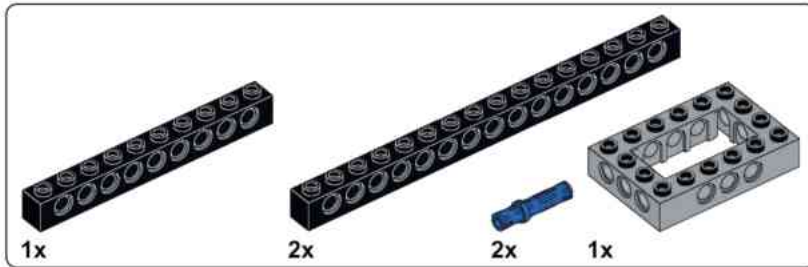

**A25**

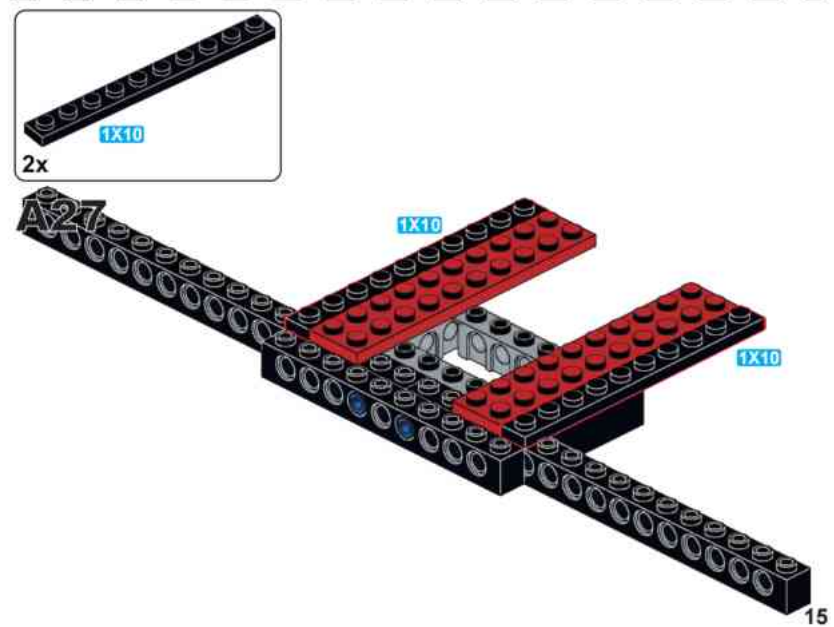
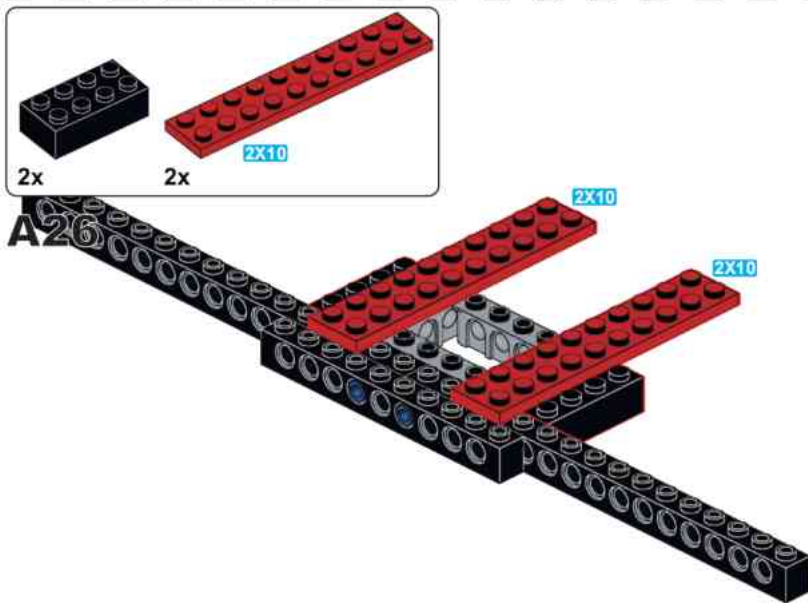
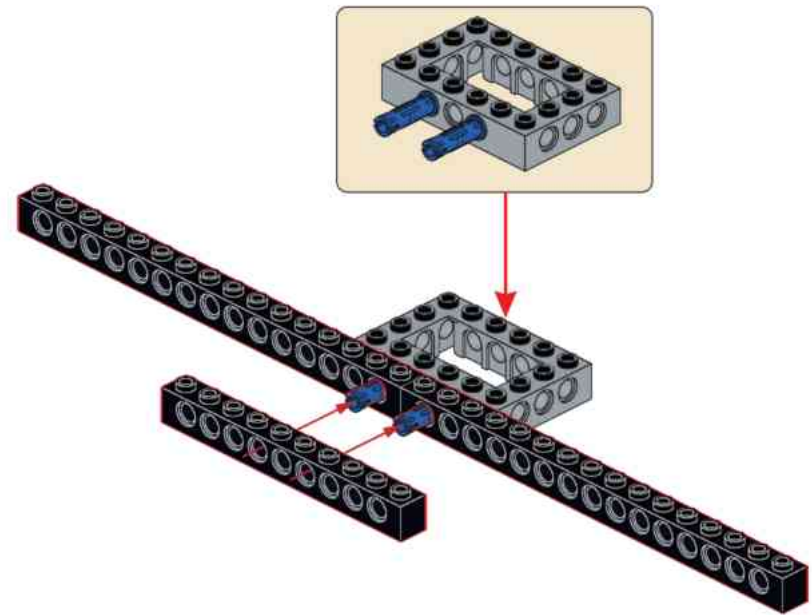

**A28**

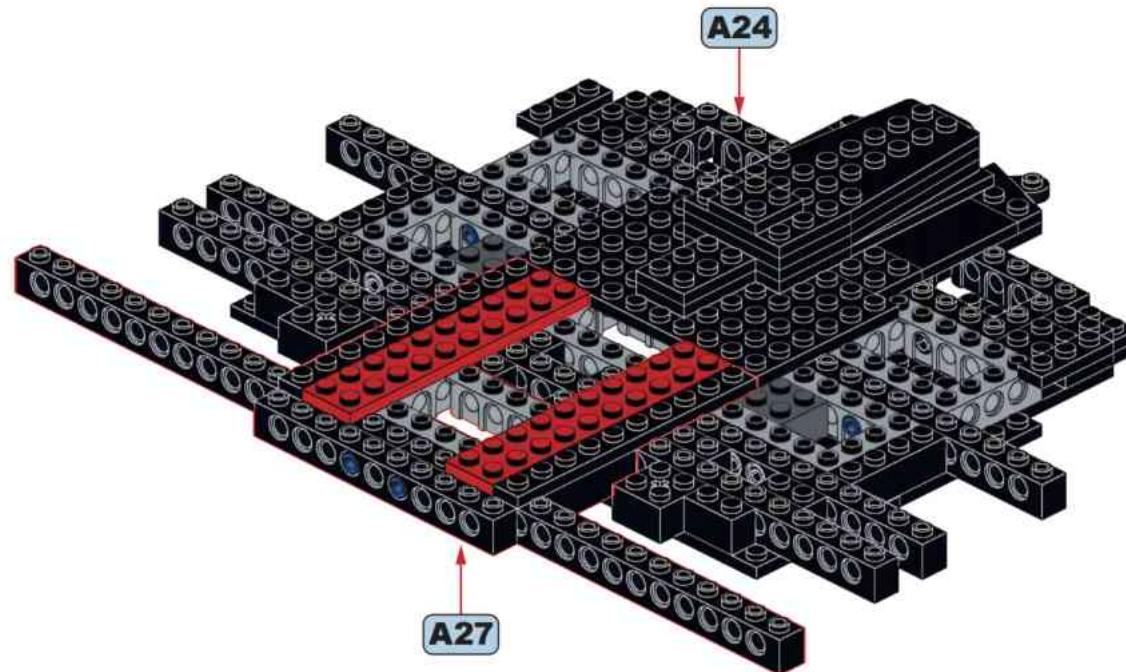

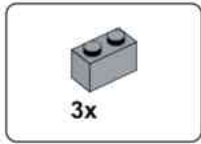

**A29**

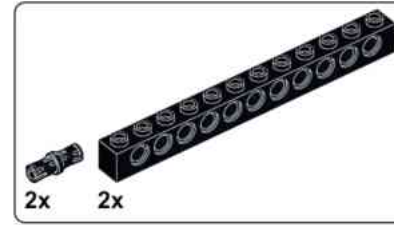
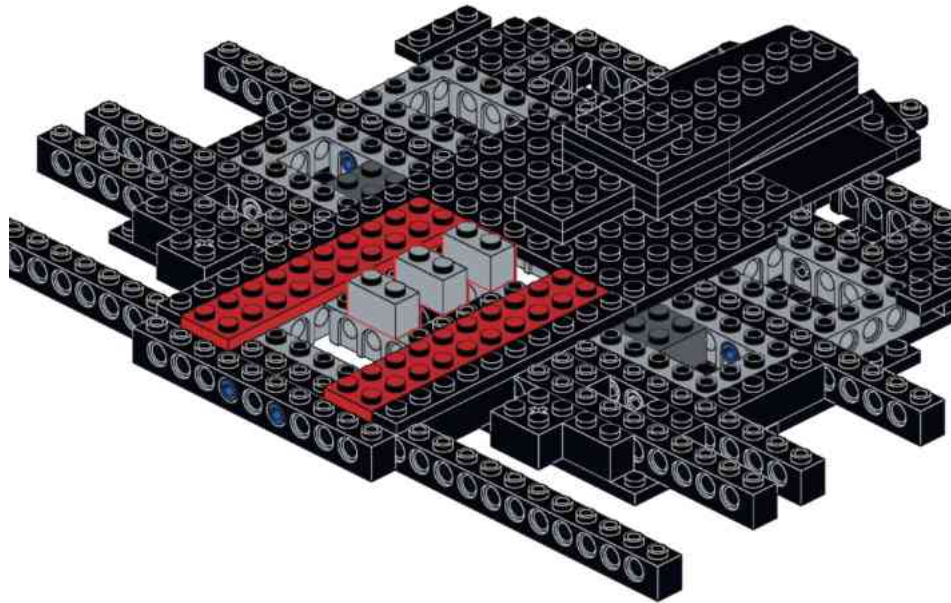

**A30**

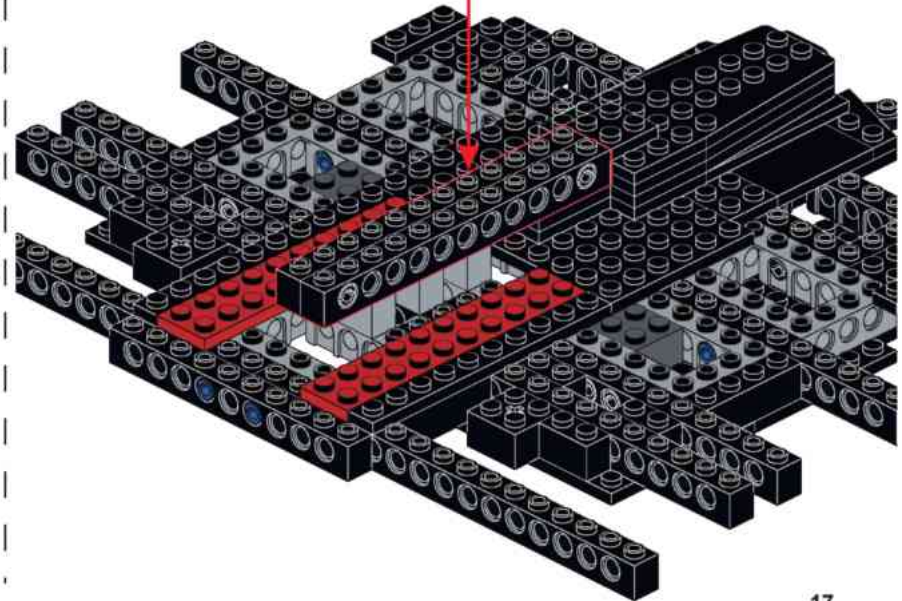
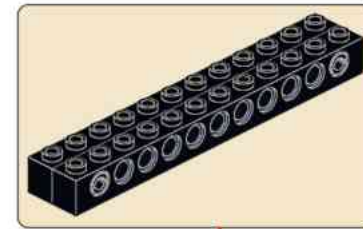

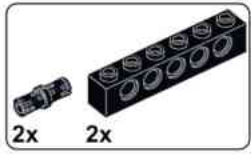

# A31

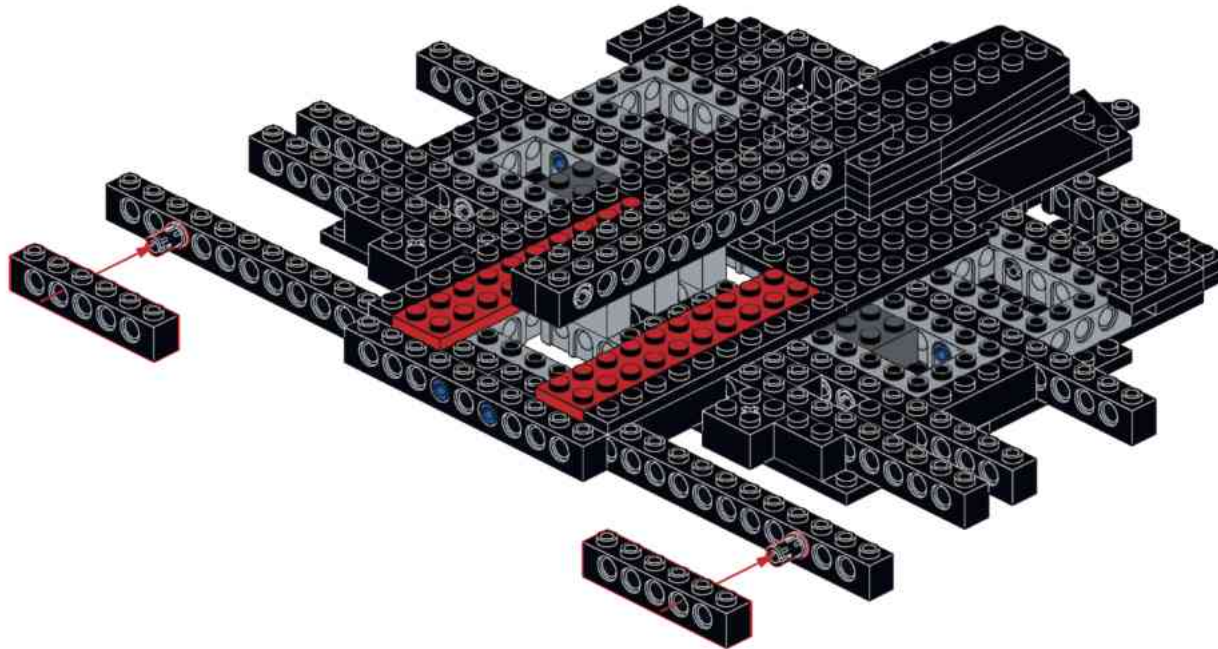

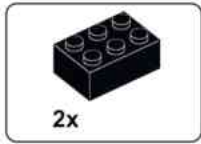

**A32**

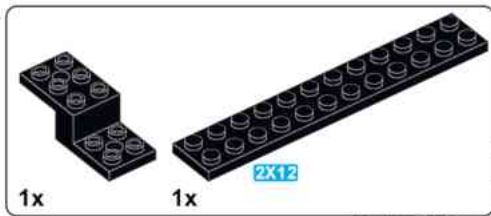
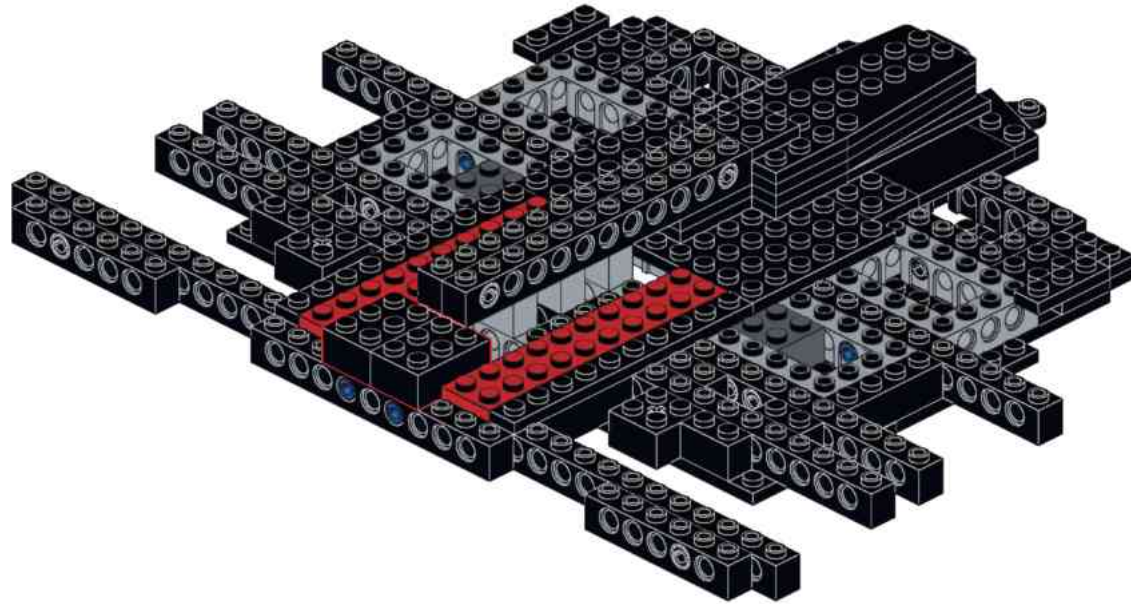

**A33**

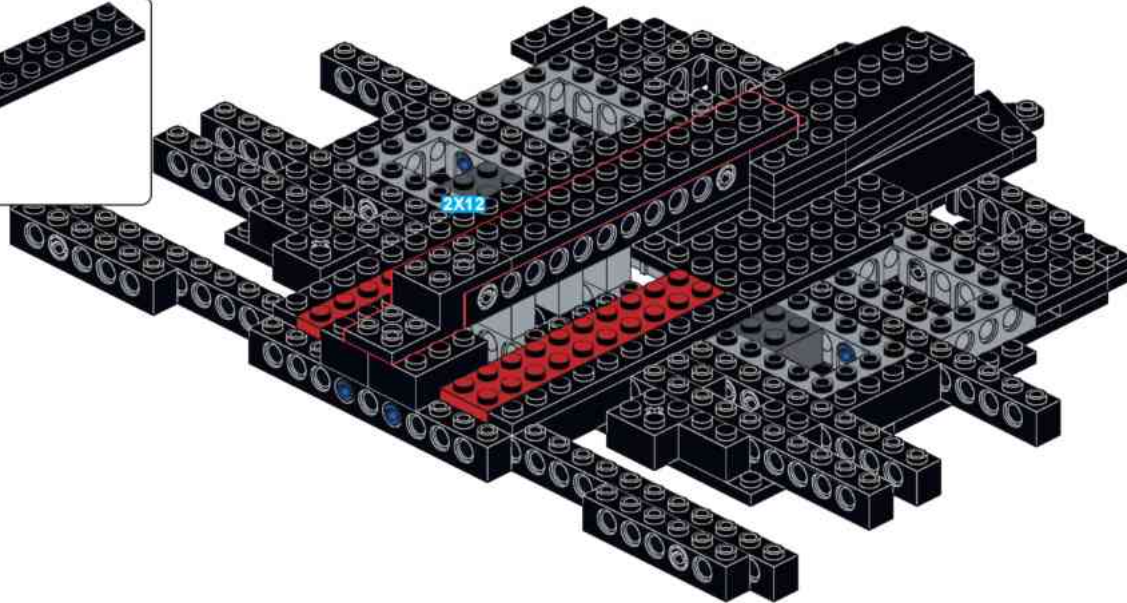

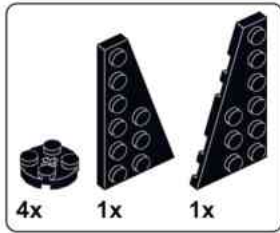

# A34

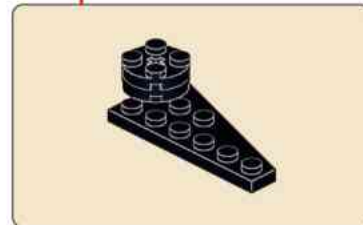
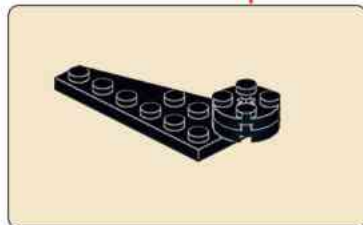
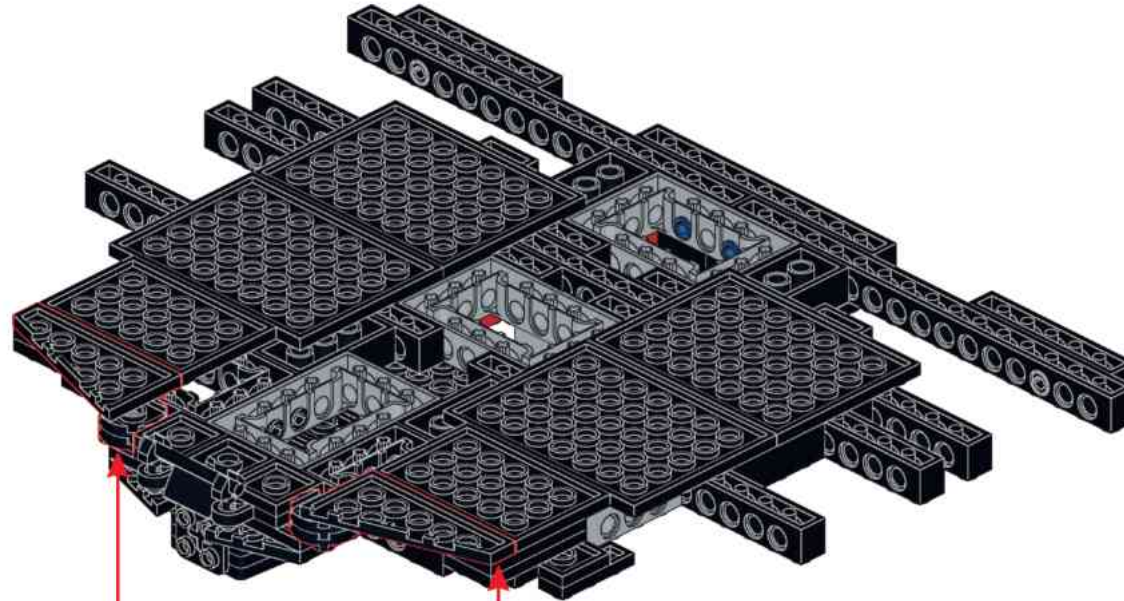



**A35**

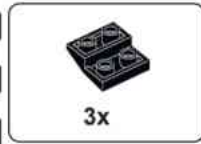

**A36**

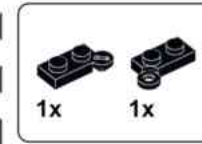

**A37**

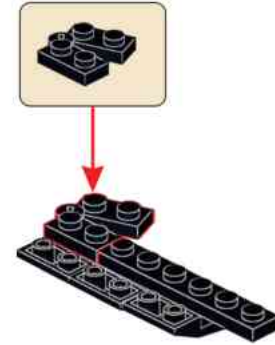

**A38**



**A39**





**A40**

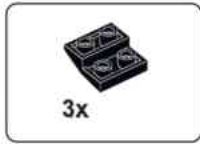

**A41**

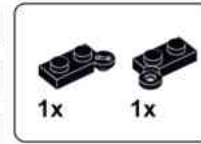

**A42**

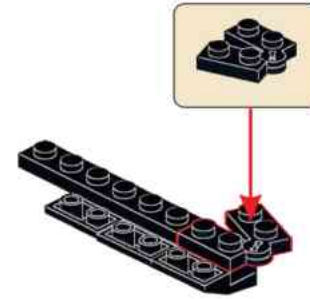

**A43**



**A44**



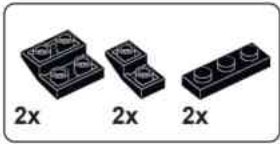

## A45

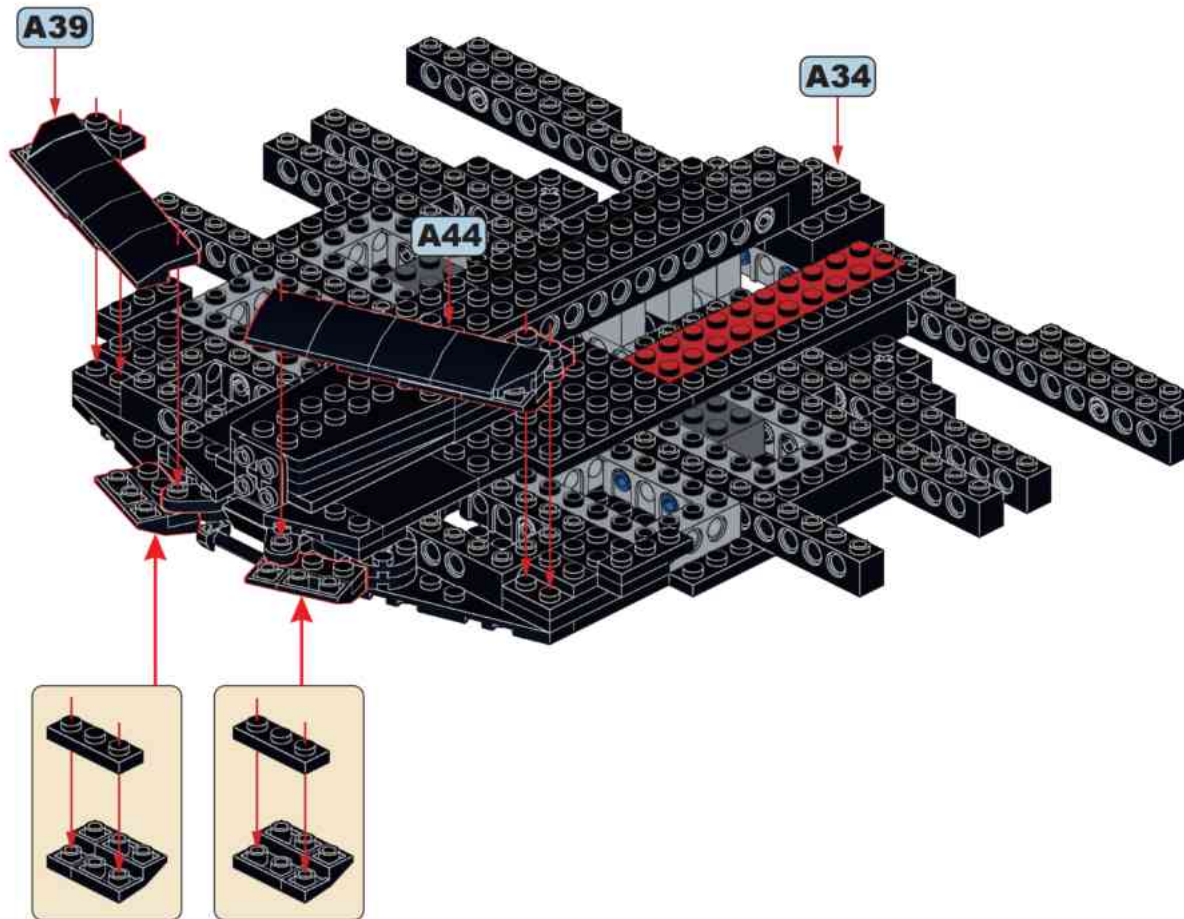



**A46**

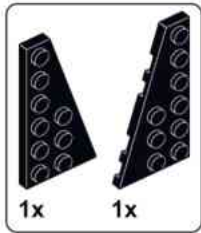
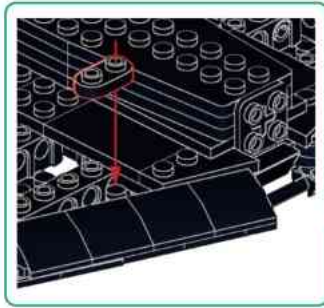

**A47**

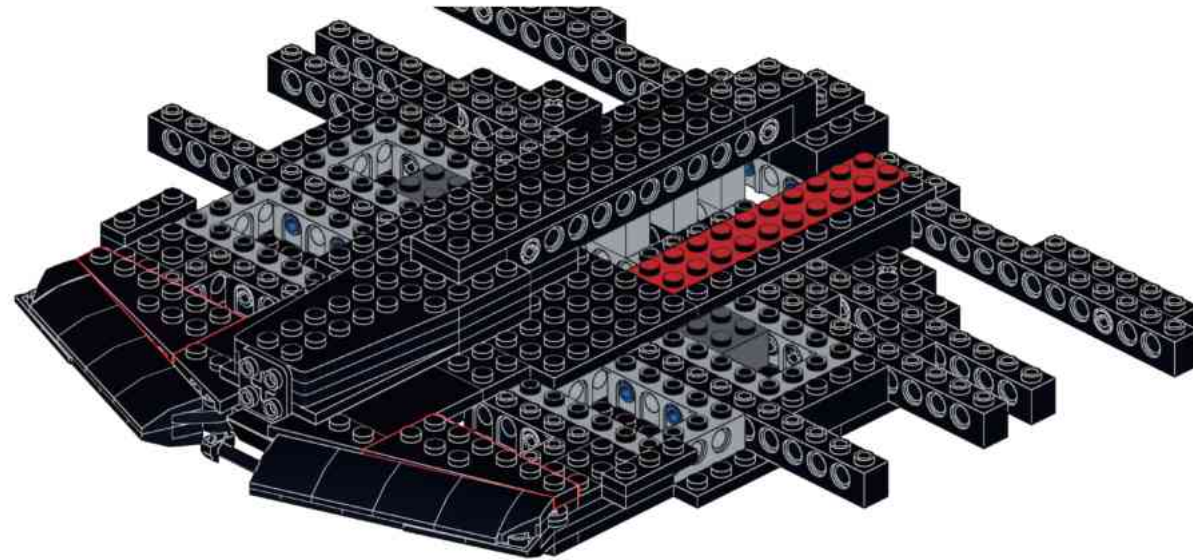

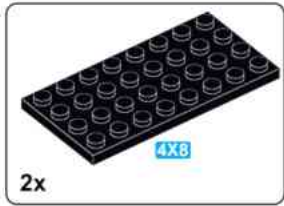

2x

**A48**

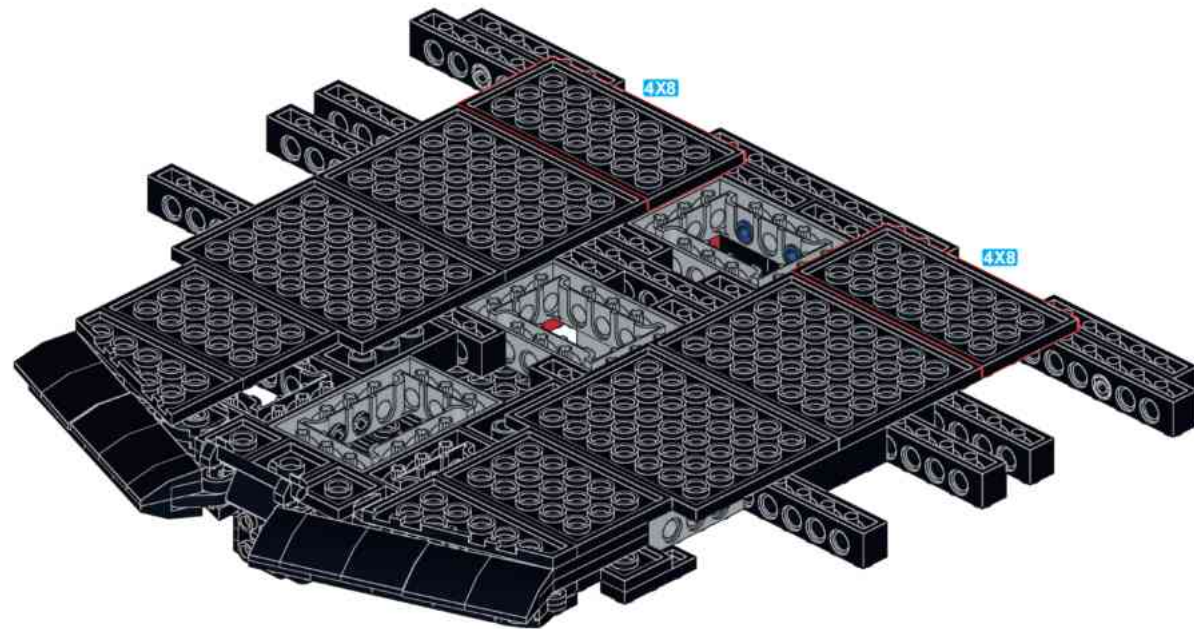

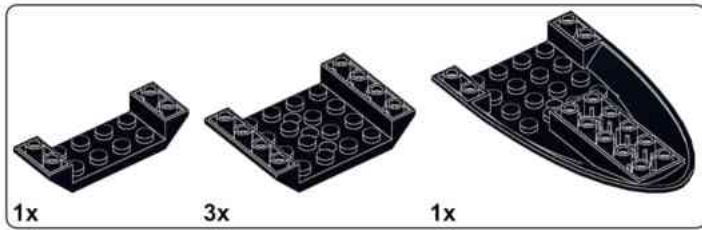

# A49

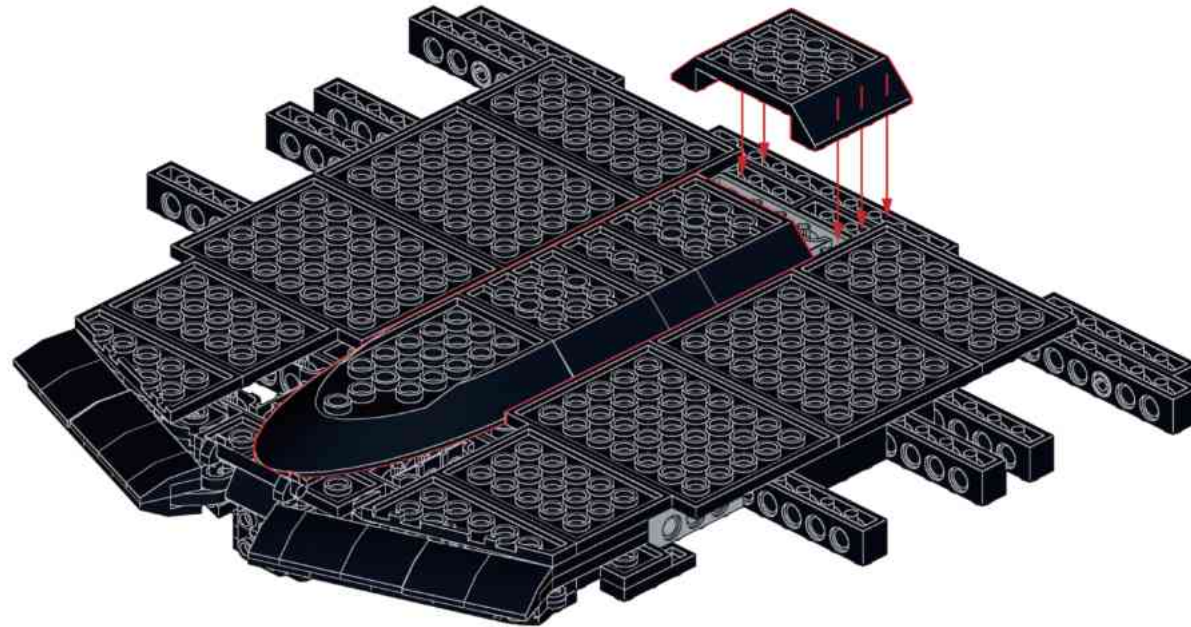

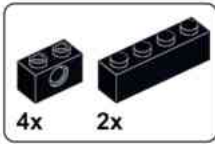

**A50**

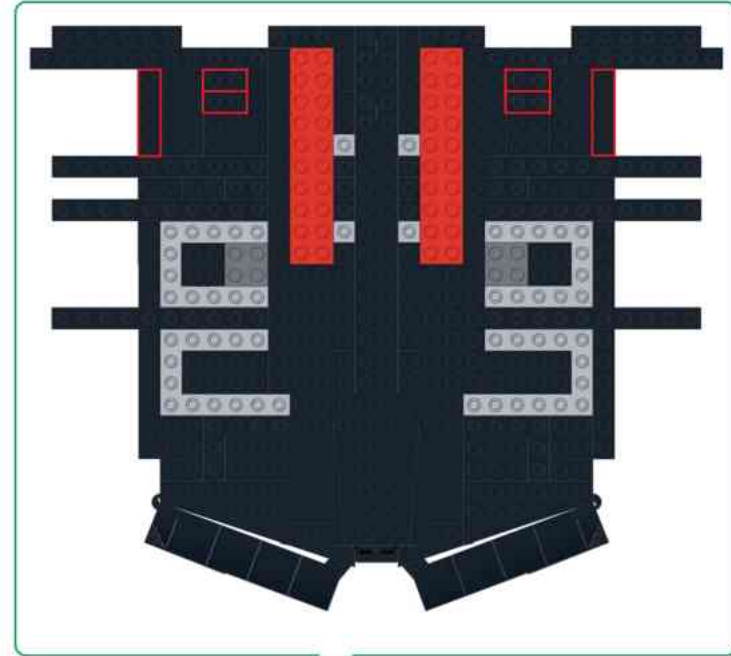
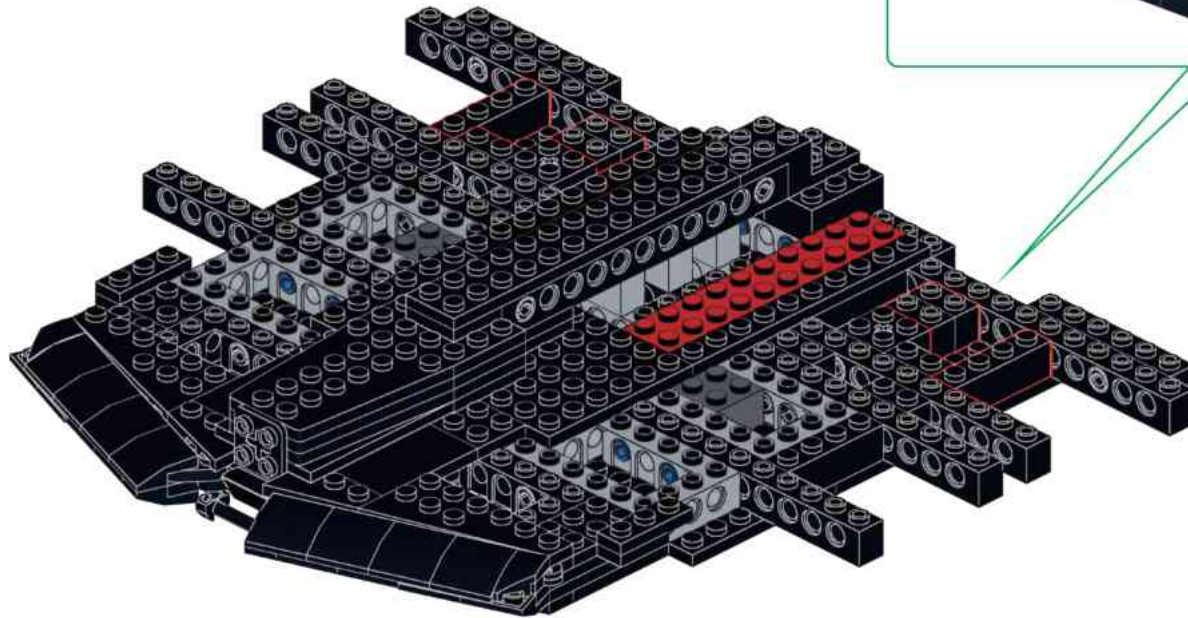

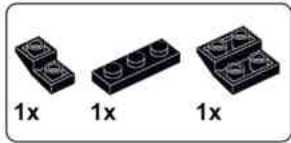

**A51**

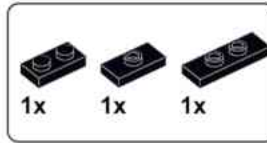
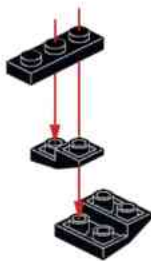

**A52**

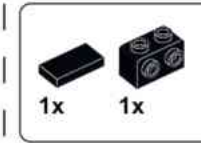
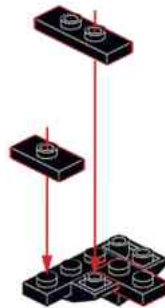

**A53**

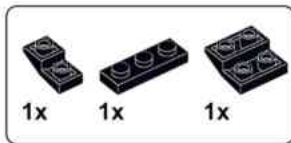
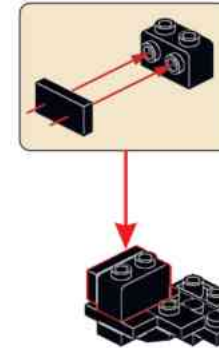

**A54**

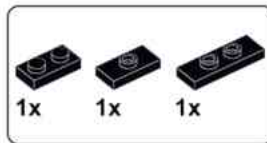

**A55**

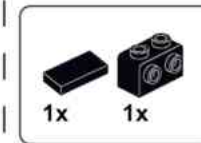

**A56**

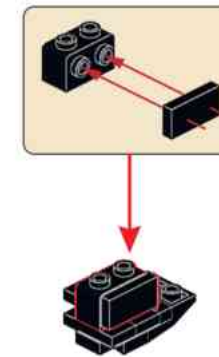

**A57**

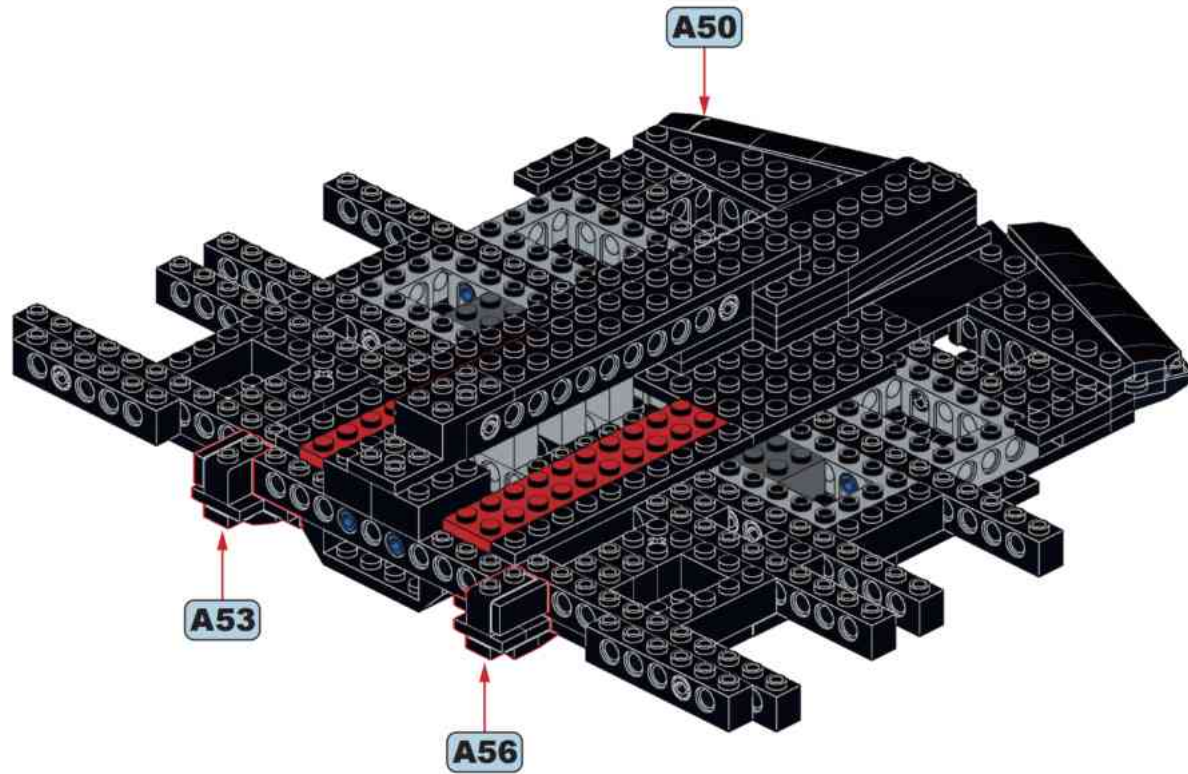



**A58**

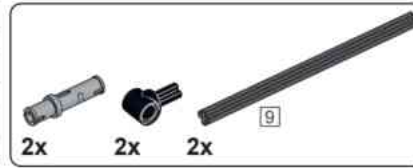

**A59**

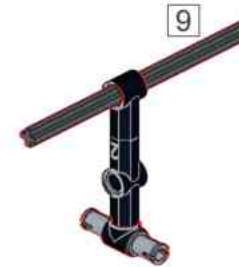

**x2**

**x2**



**A60**

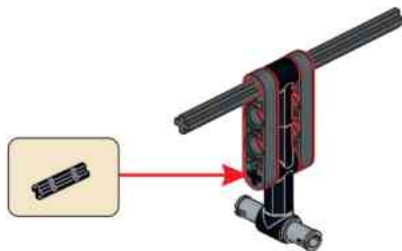

**A61**

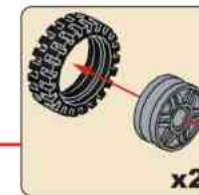

**x2**

**x2**

## A62

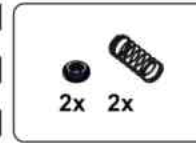
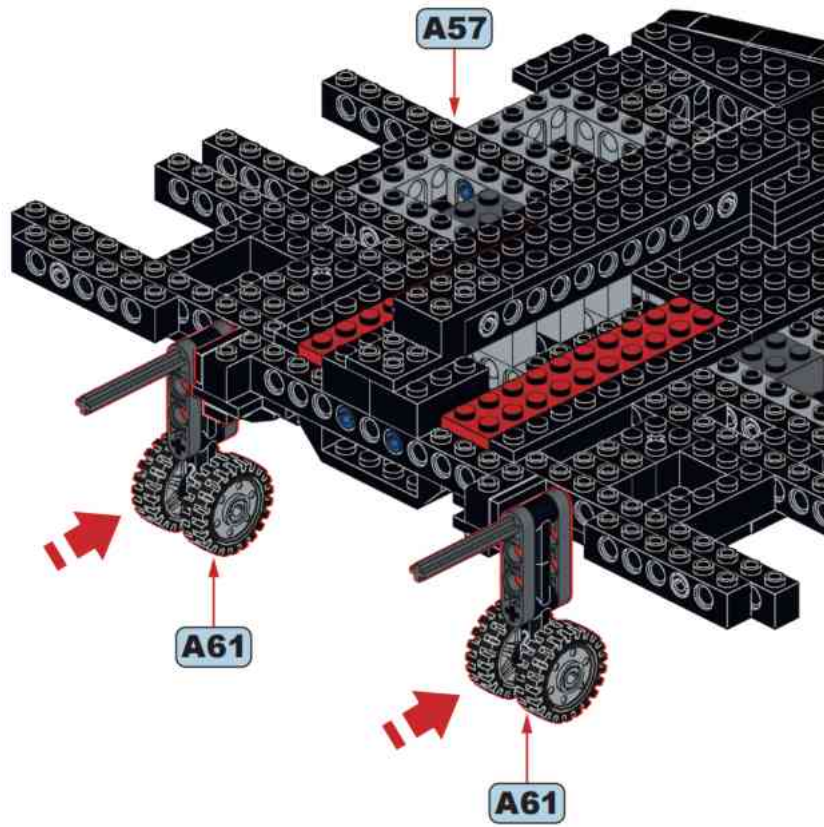

## A63

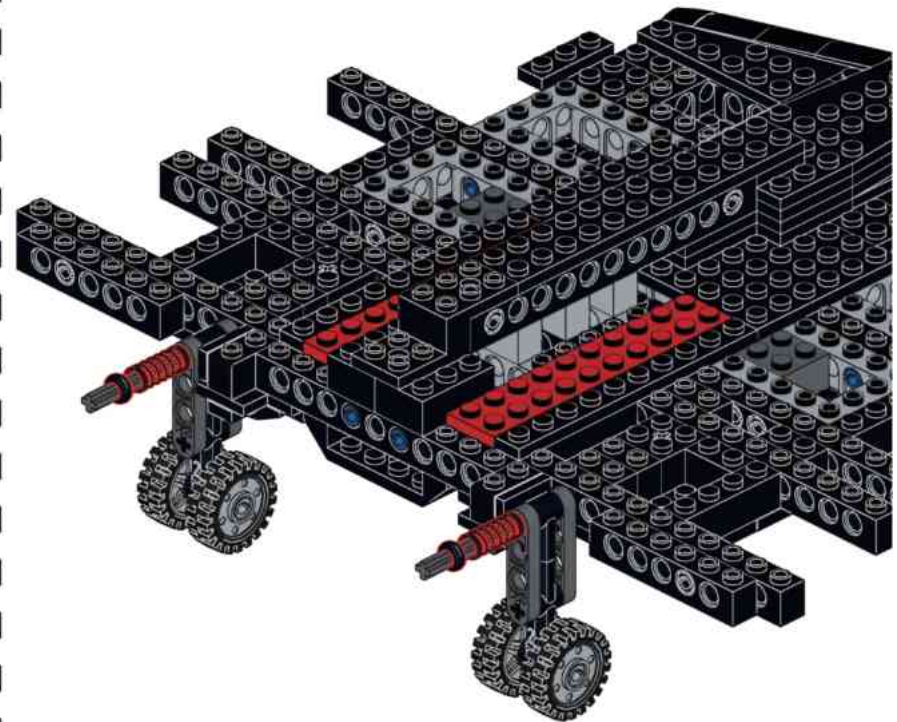

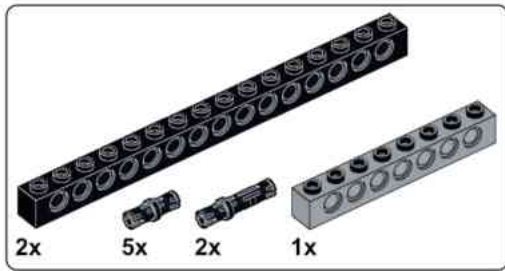

**A64**

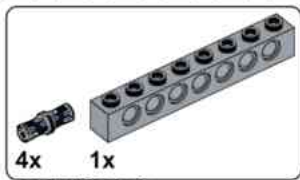
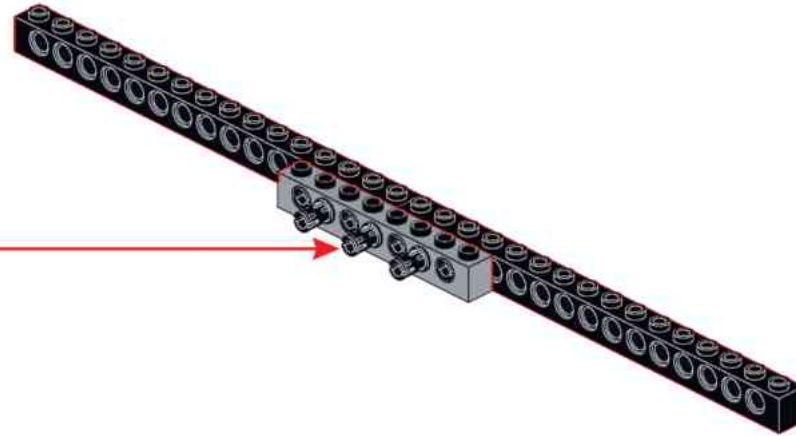
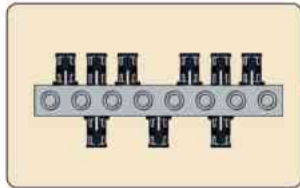

**A65**

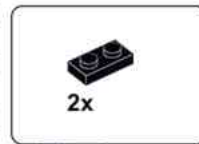
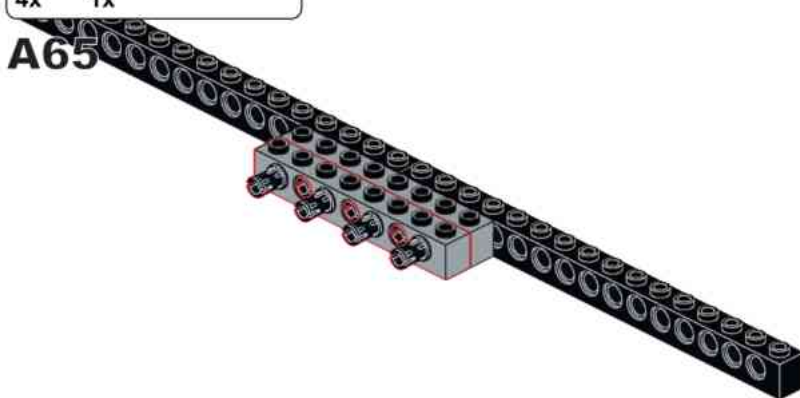

**A66**

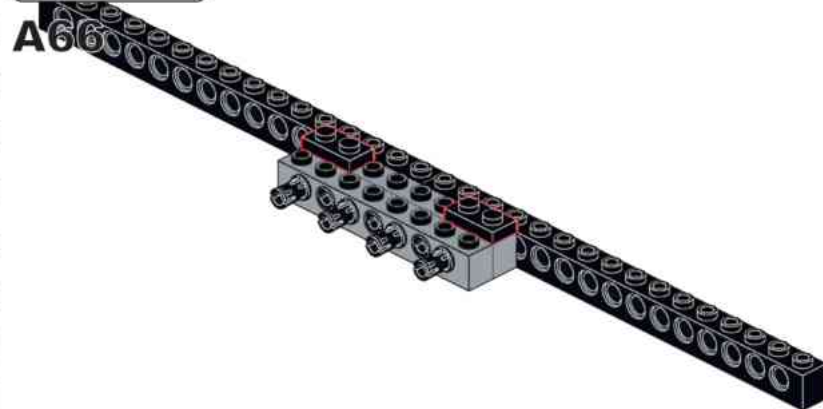

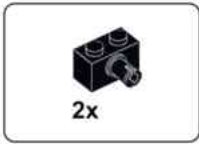

**A67**

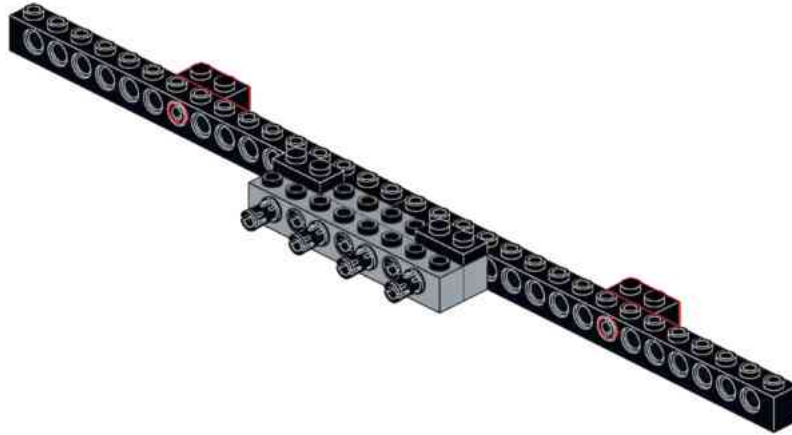

**A68**

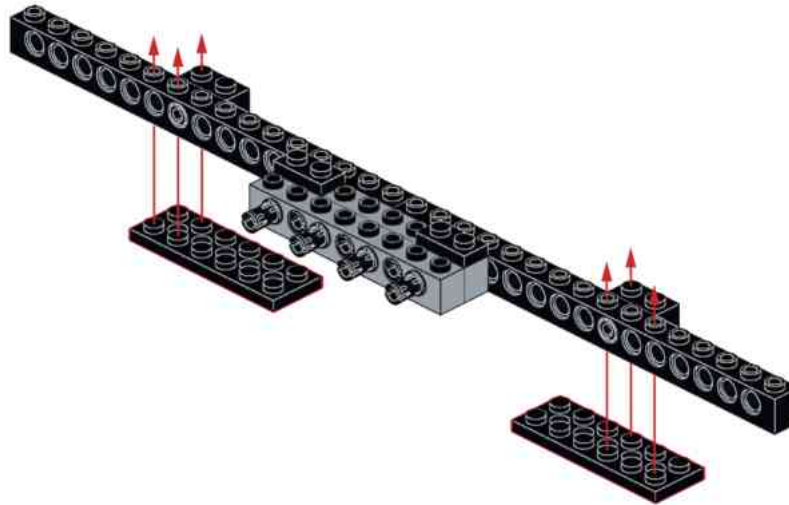



### A69

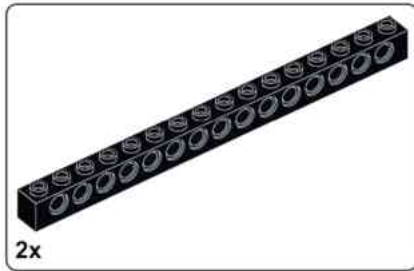
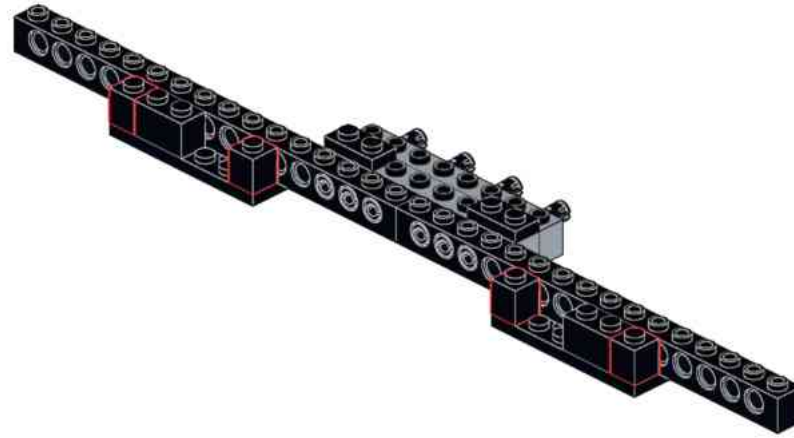

### A70

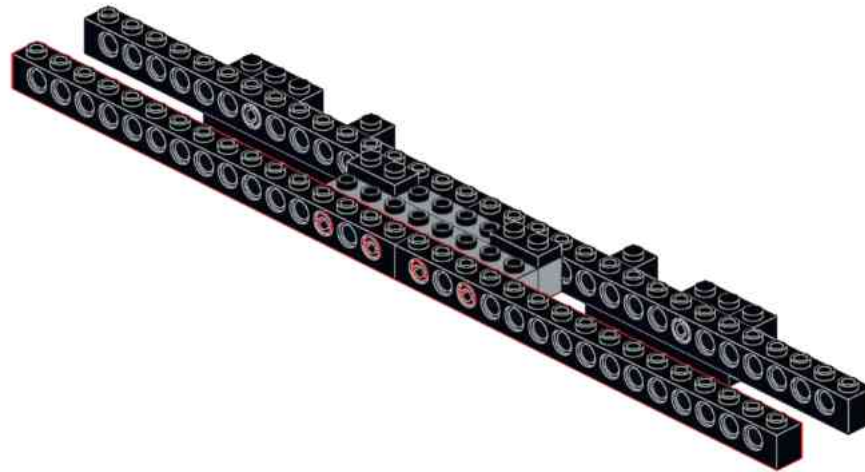

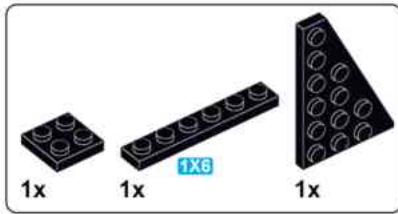

**A71**

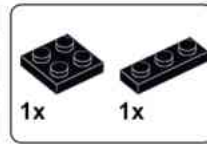

**A72**

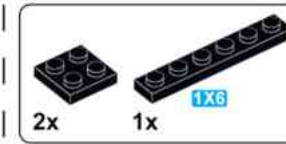

**A73**

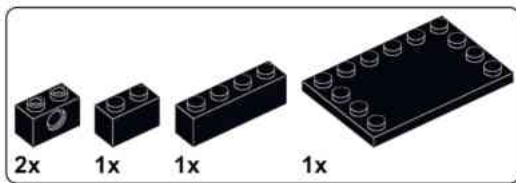
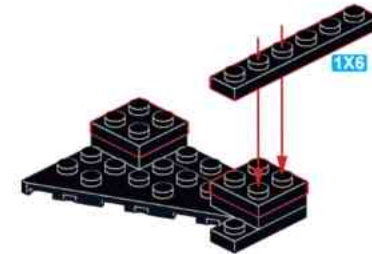

**A74**

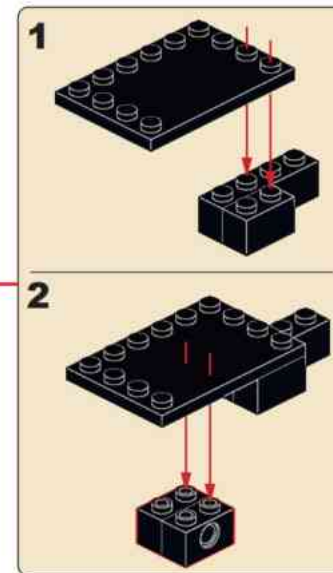
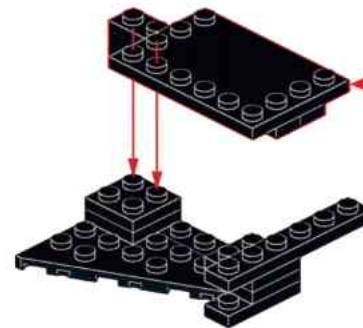

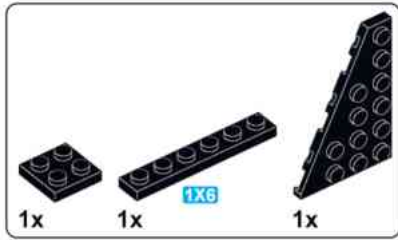

**A75**

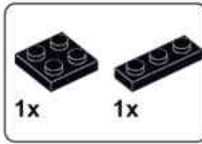

**A76**

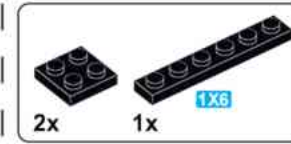

**A77**

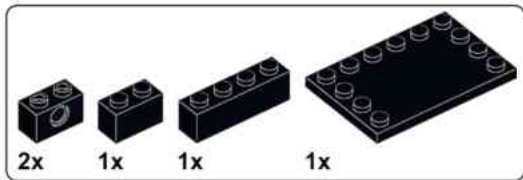
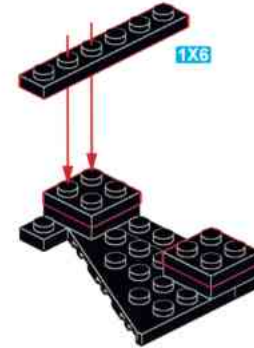

**A78**

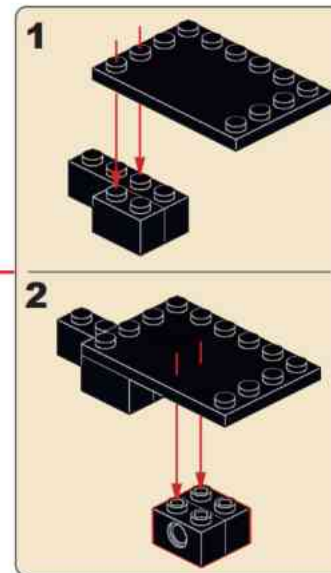
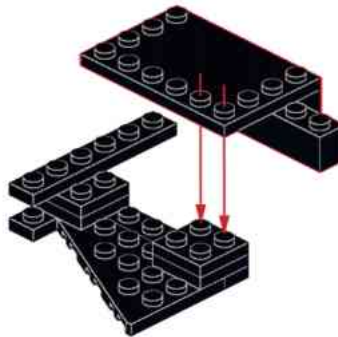

**A79**

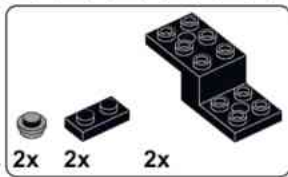
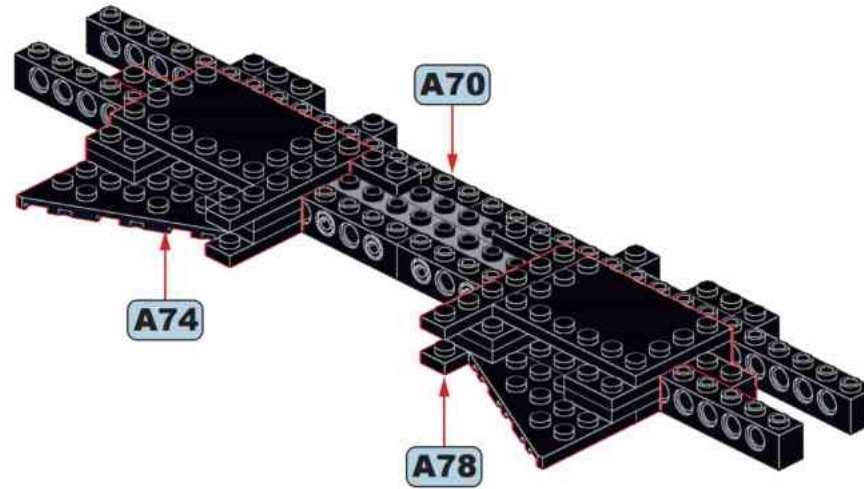

**A80**

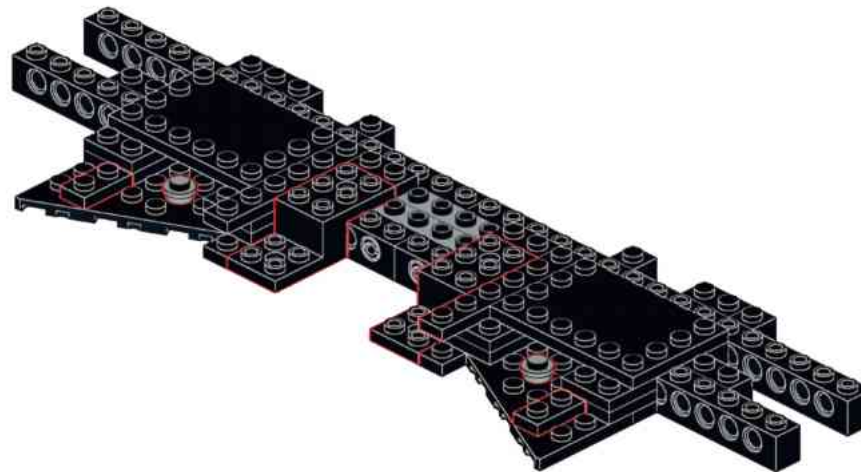



## A81

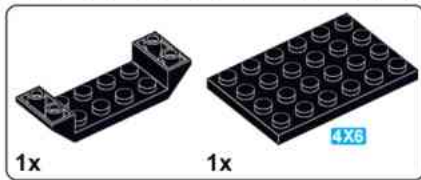
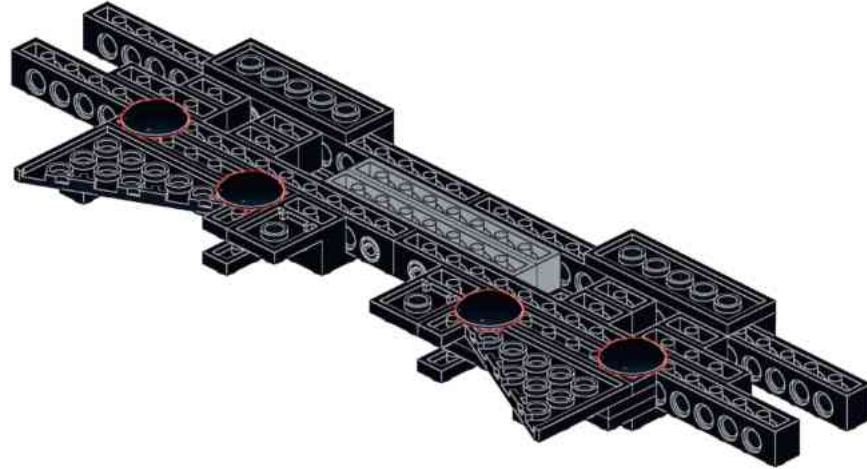

## A82

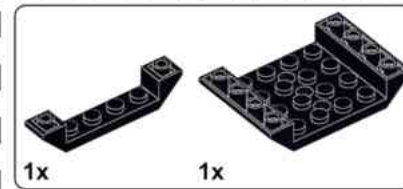

## A83



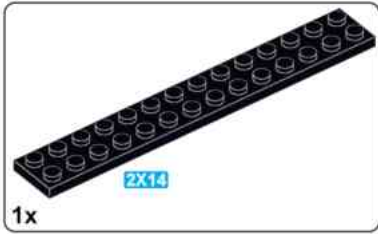

**A84**

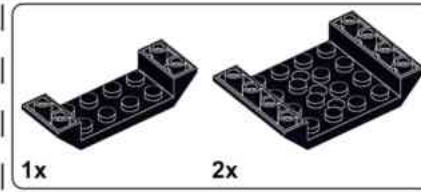

**A85**

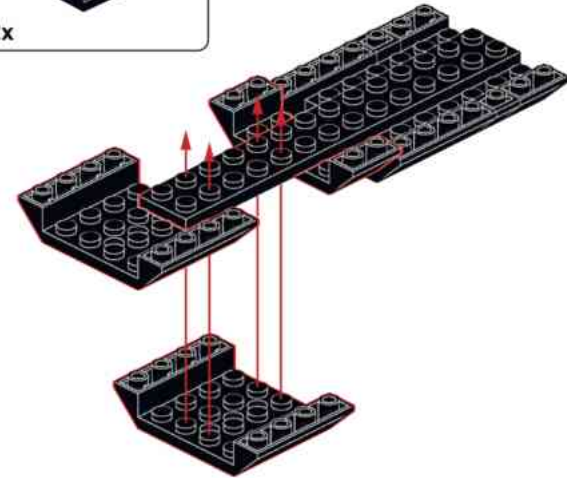

**A86**

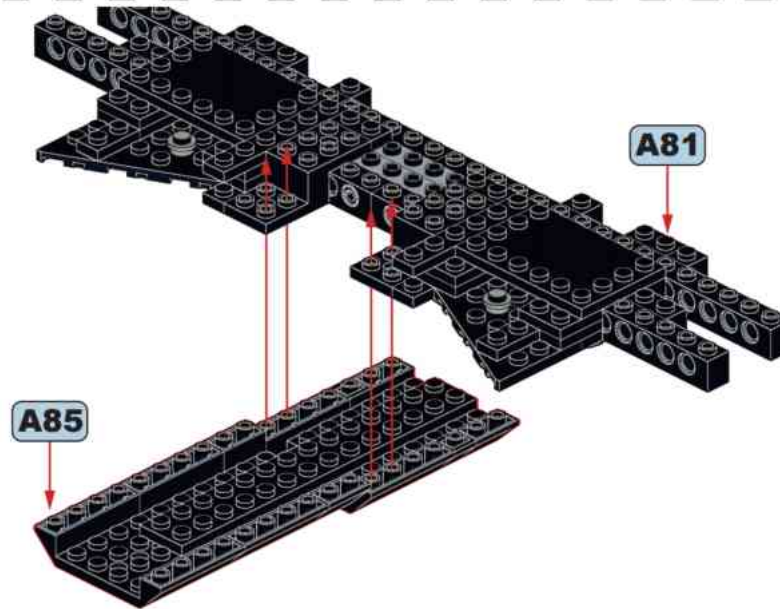

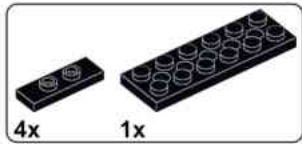

**A87**

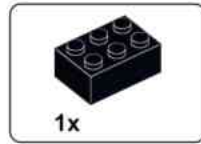

**A88**

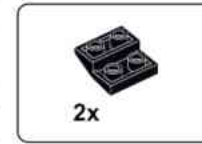
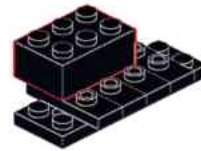

**A89**

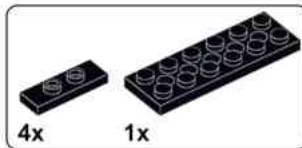
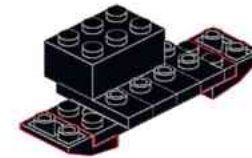

**A90**

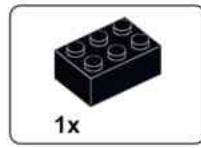

**A91**

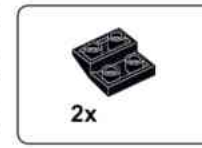
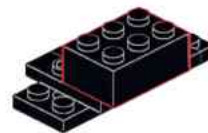

**A92**



A93

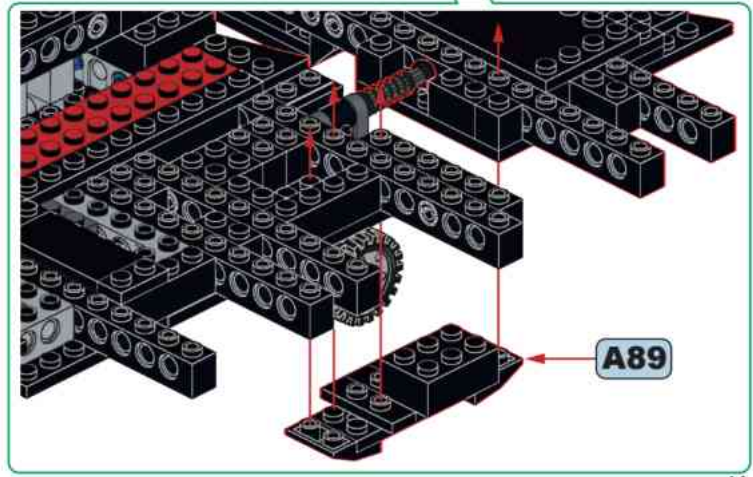
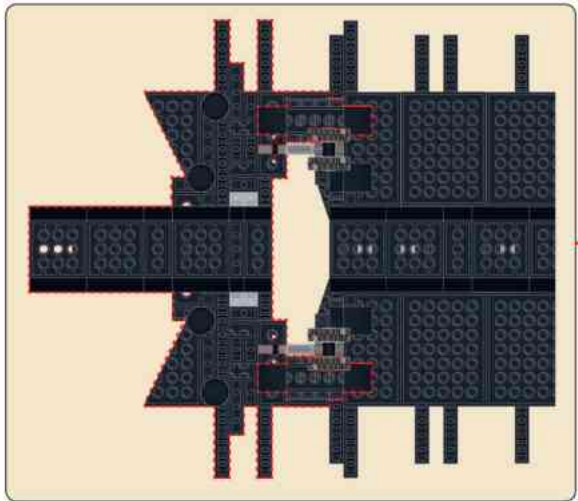
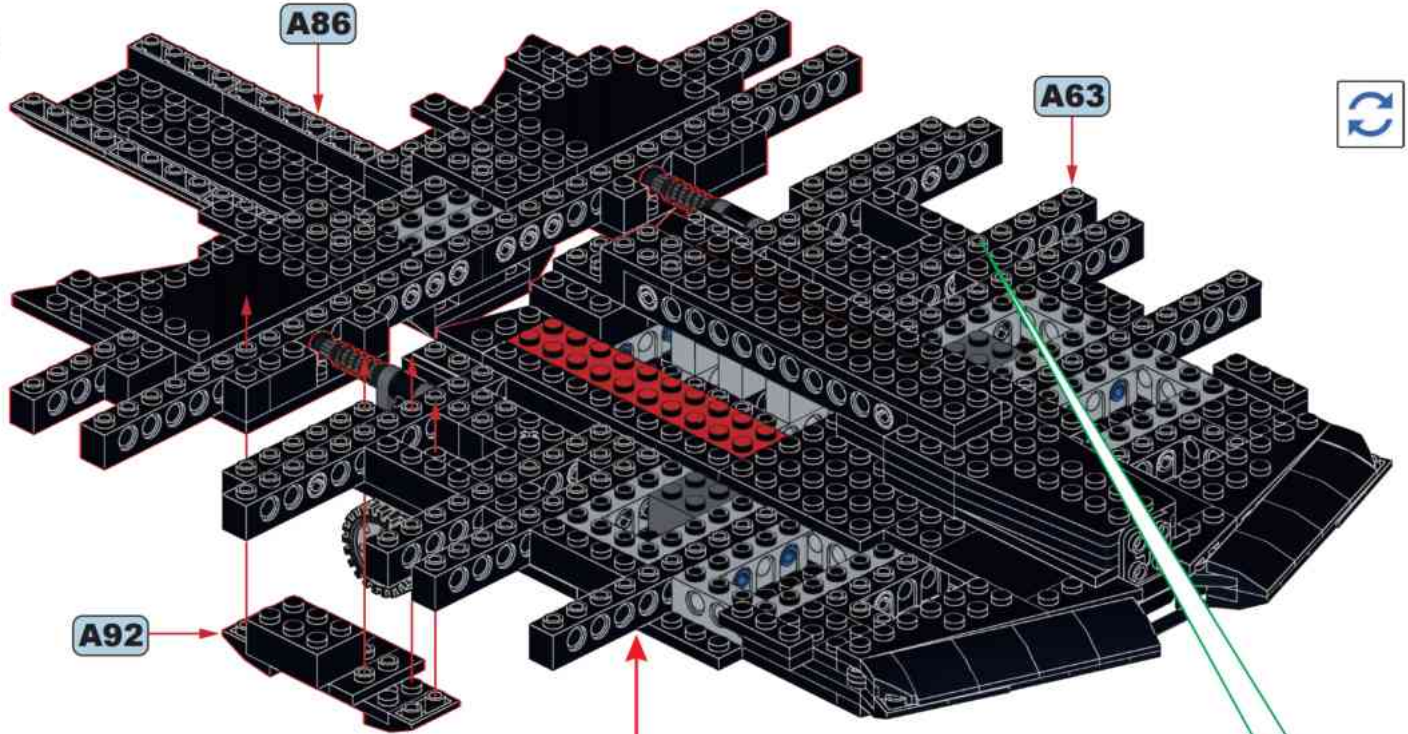

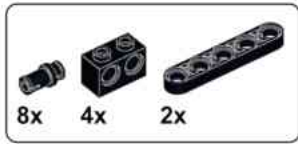

# A94

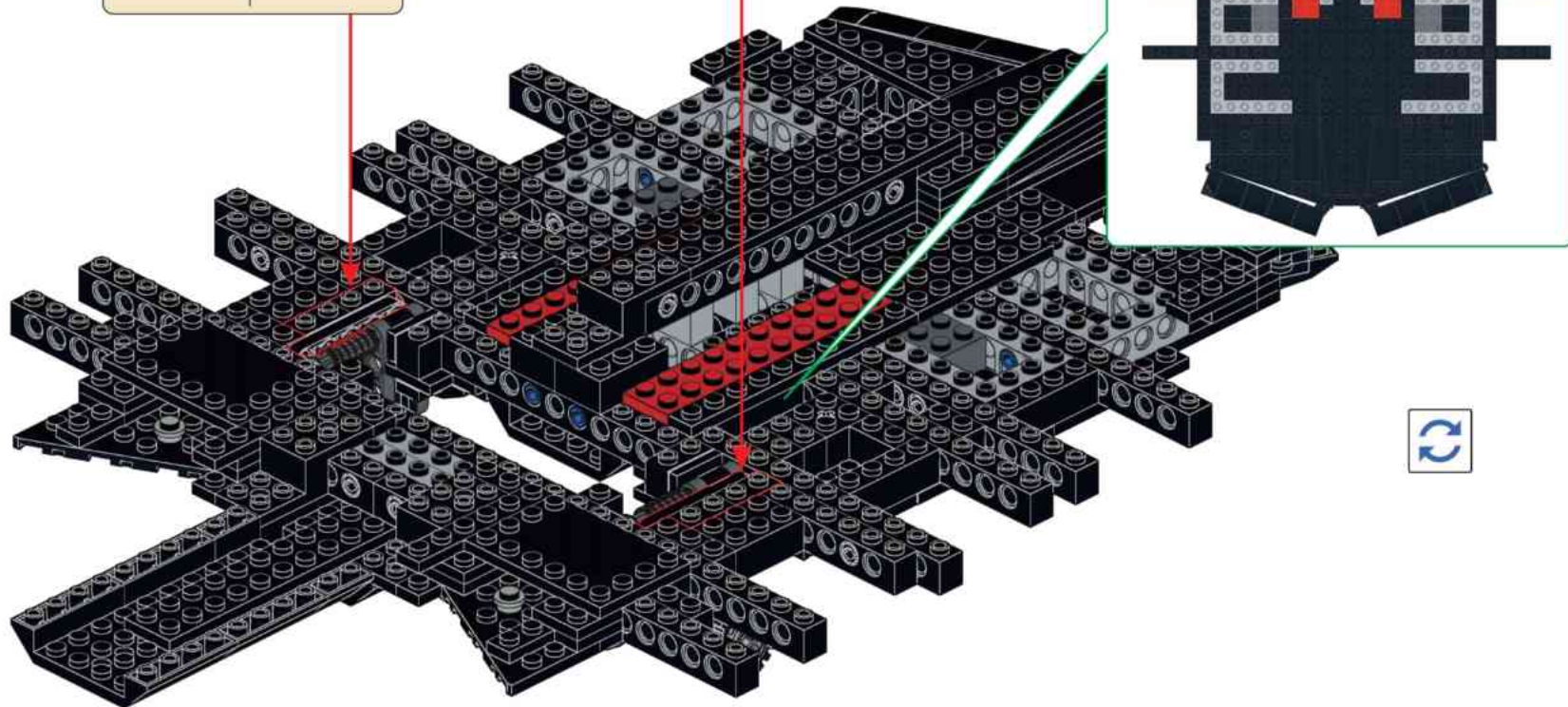
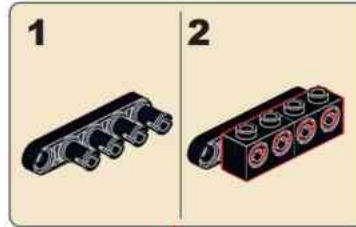
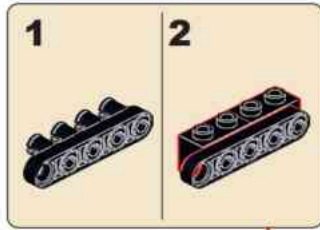

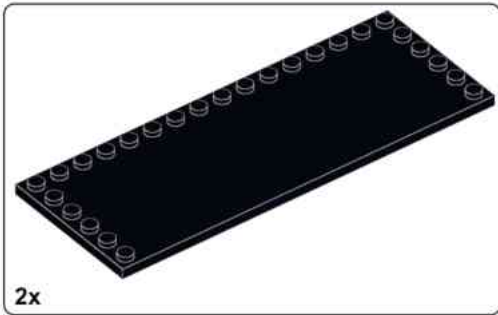

**A95**

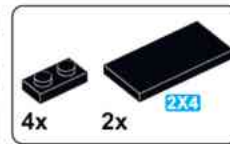
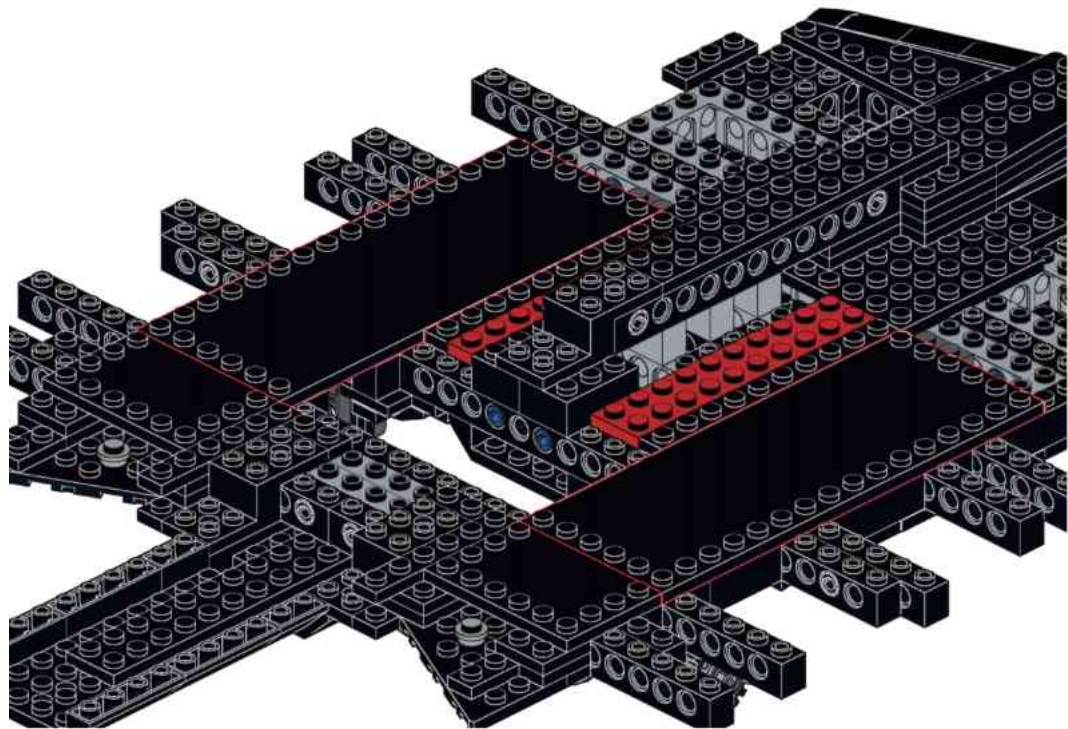

**A96**

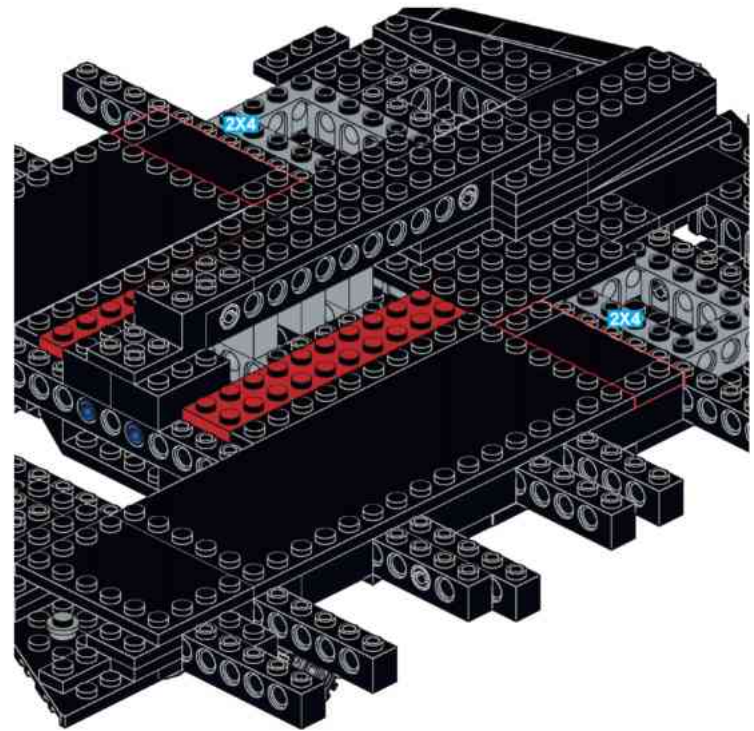

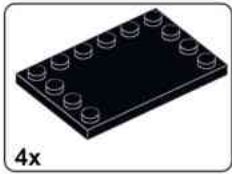

4x

**A97**

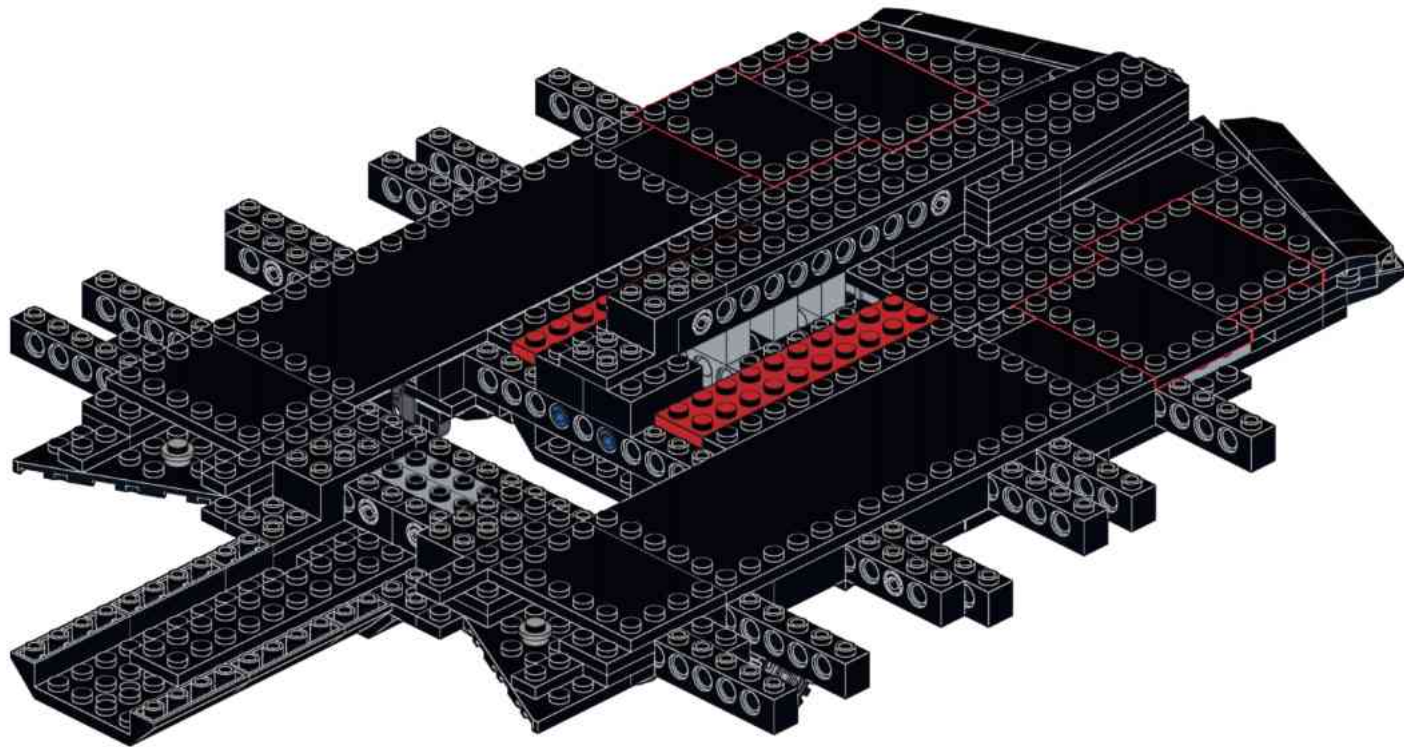

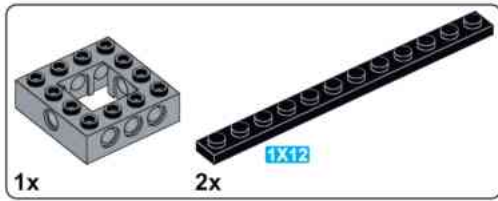

# A98

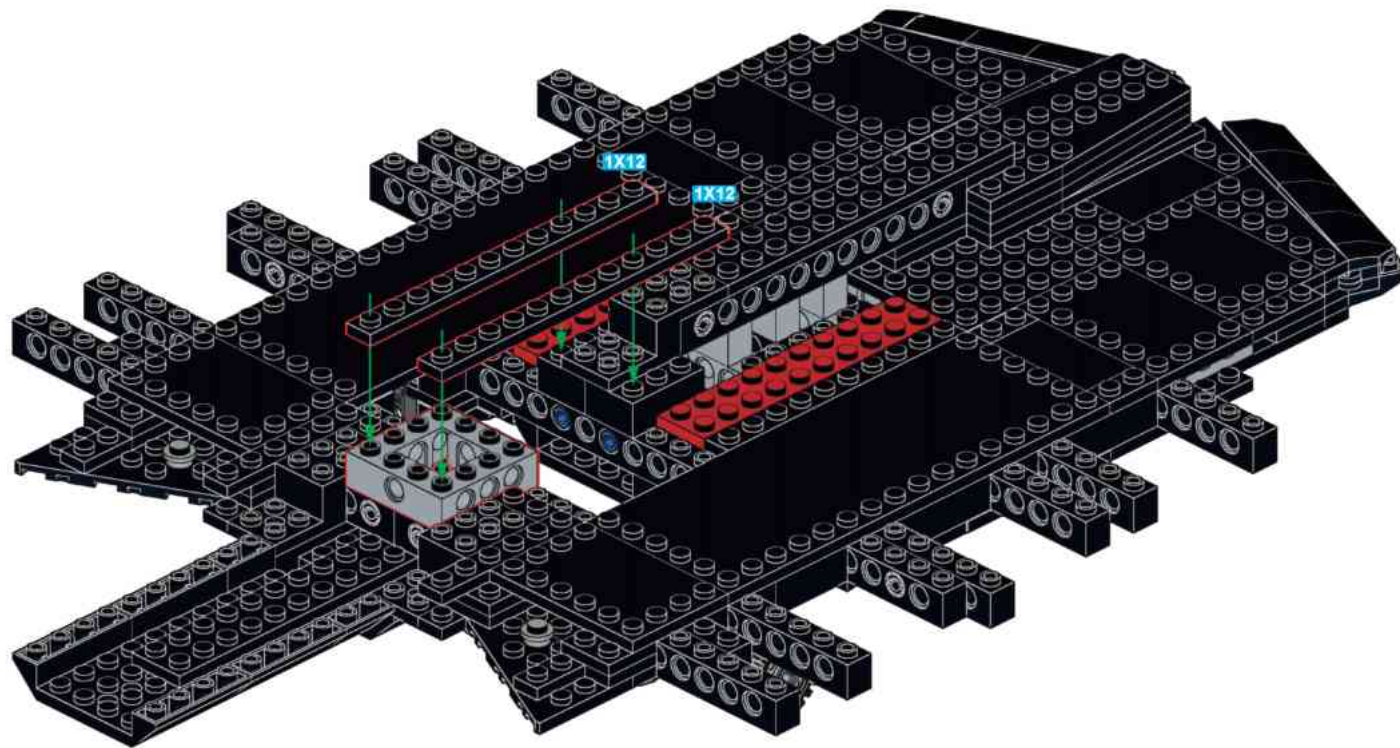

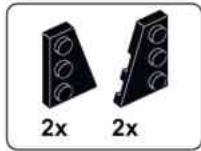

**A99**

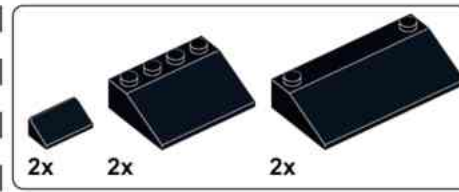
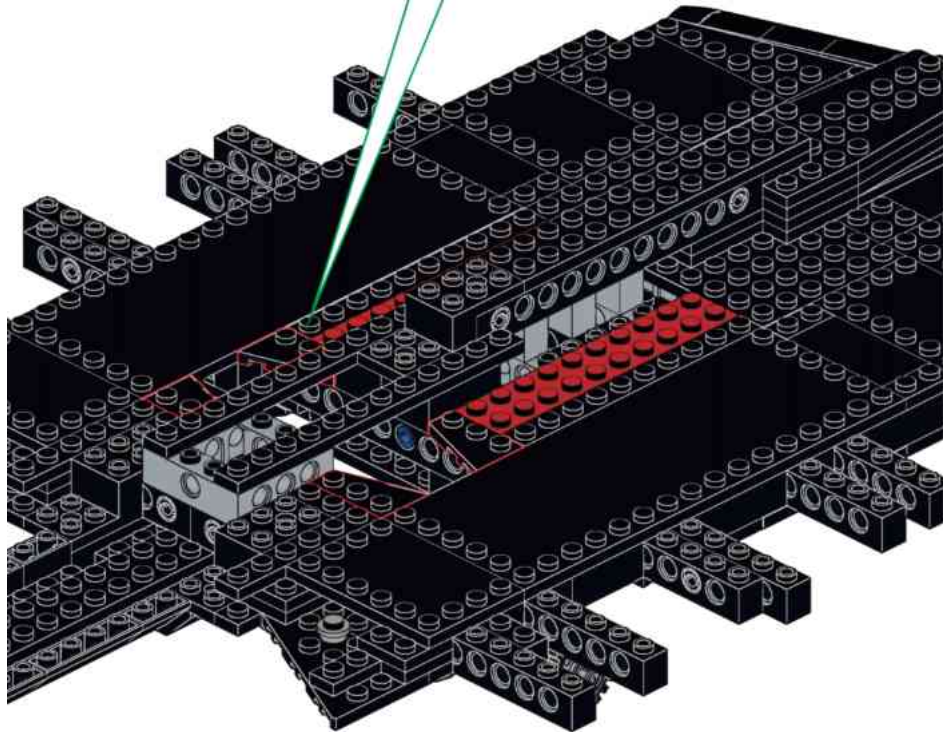
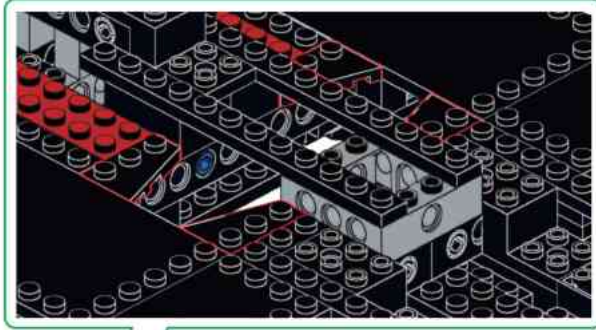

**A100**

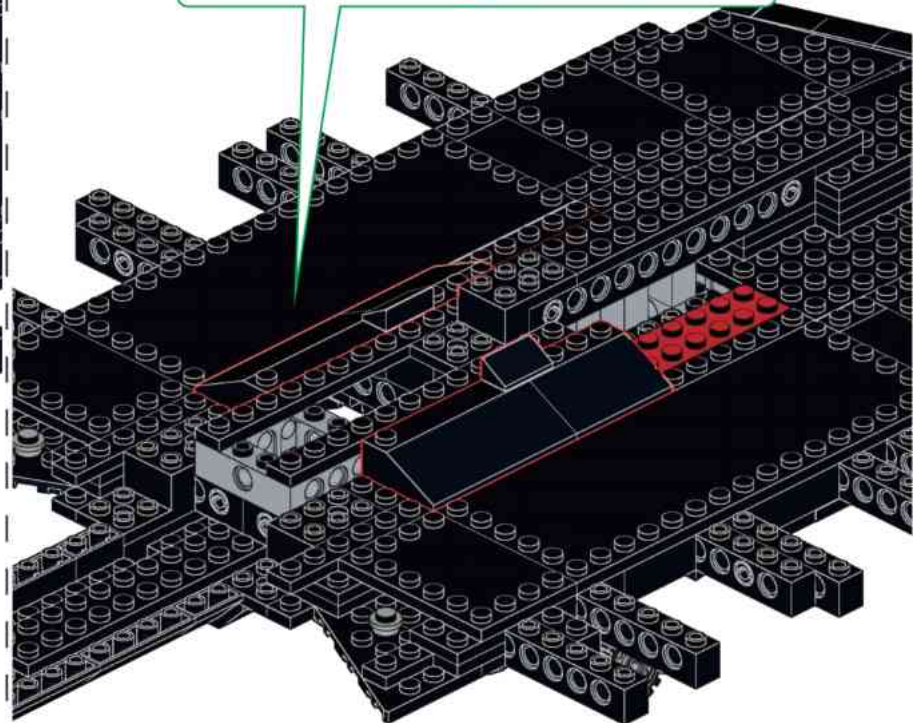
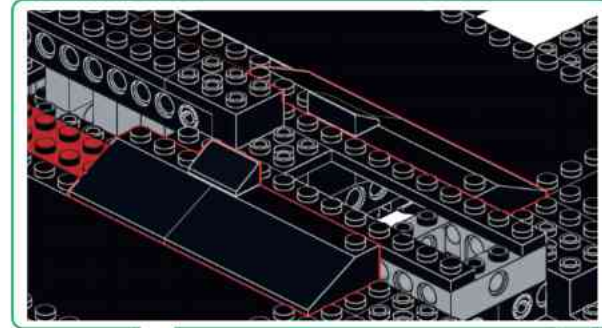

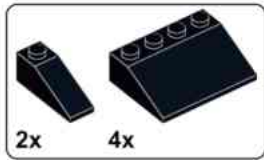

### A101

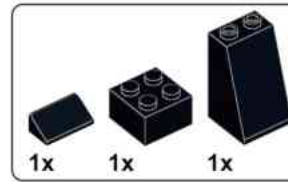
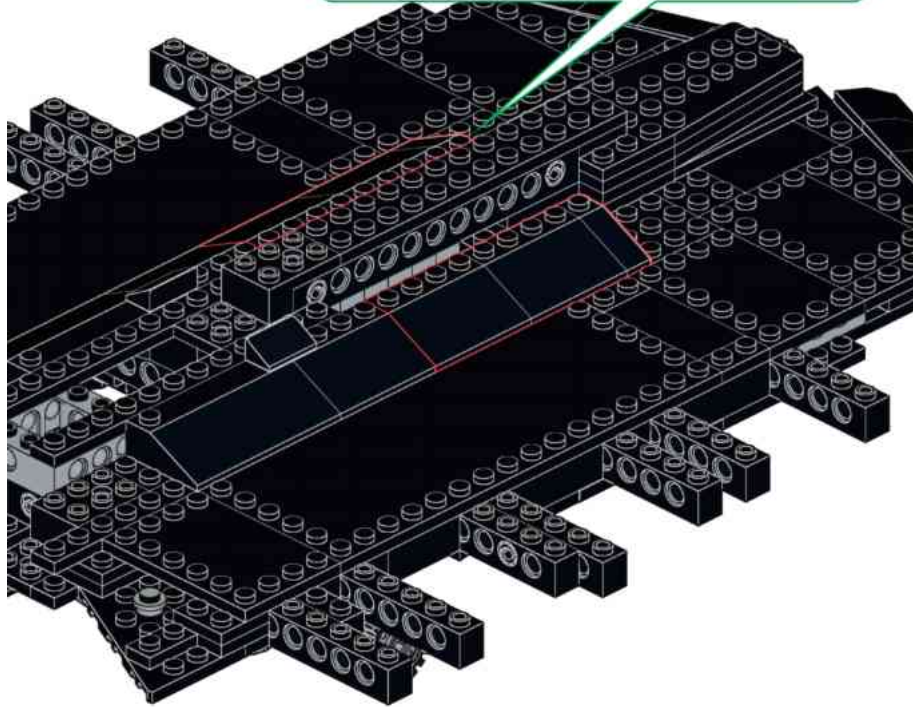
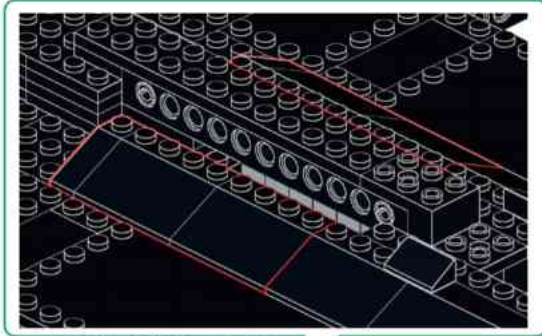

### A102

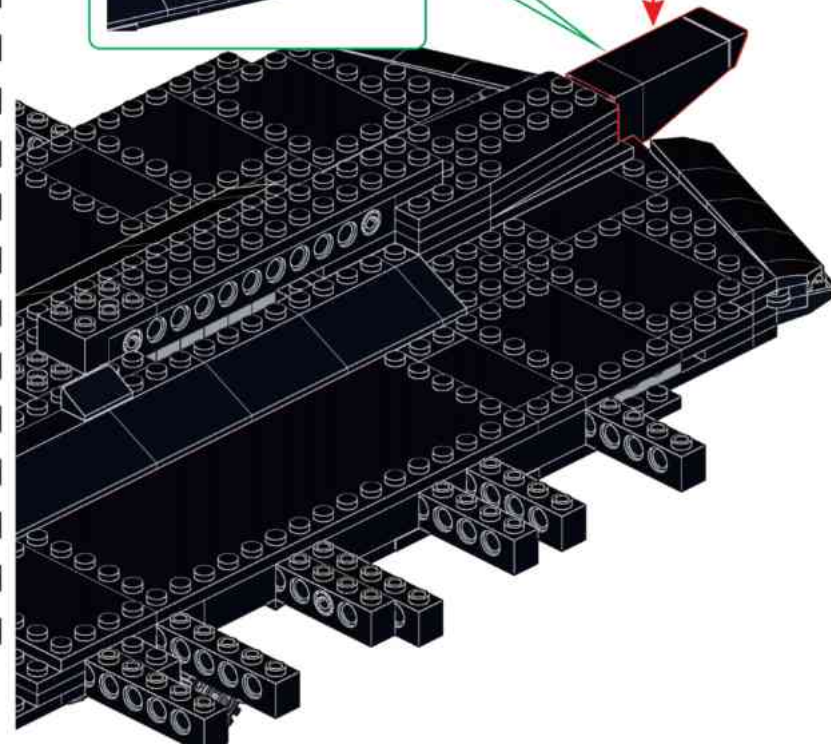
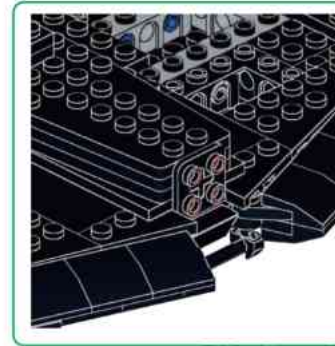
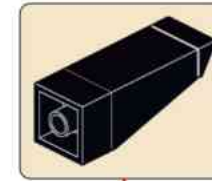

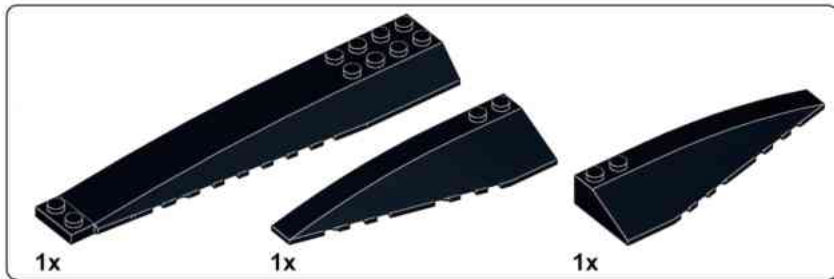

**A103**

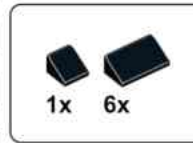
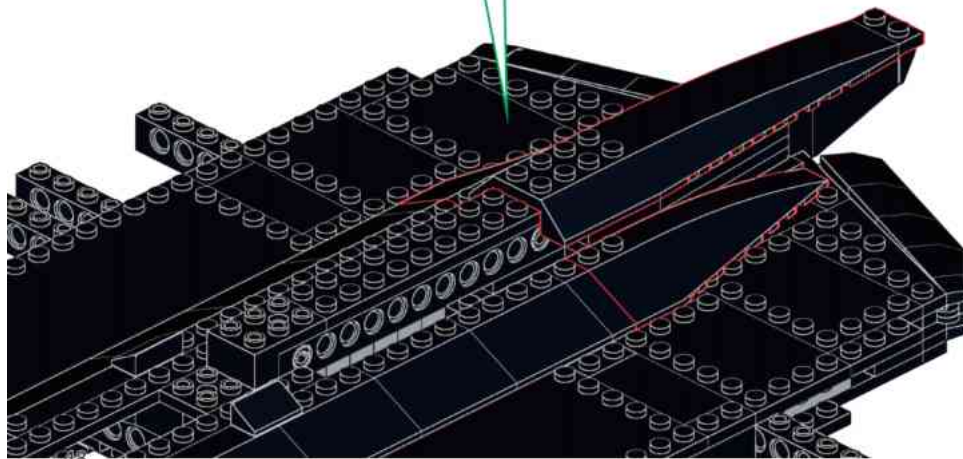
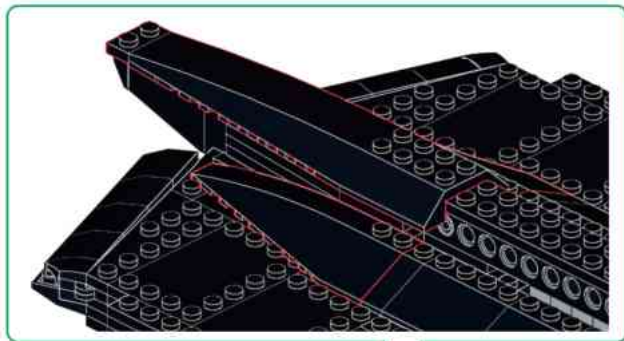

**A104**

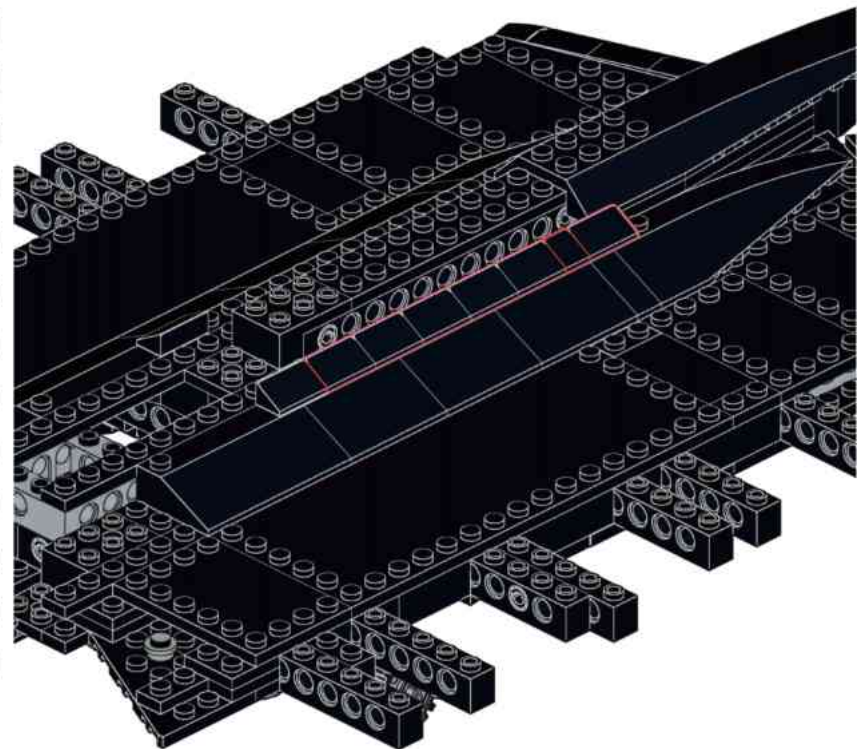

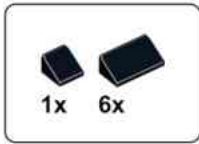

### A105

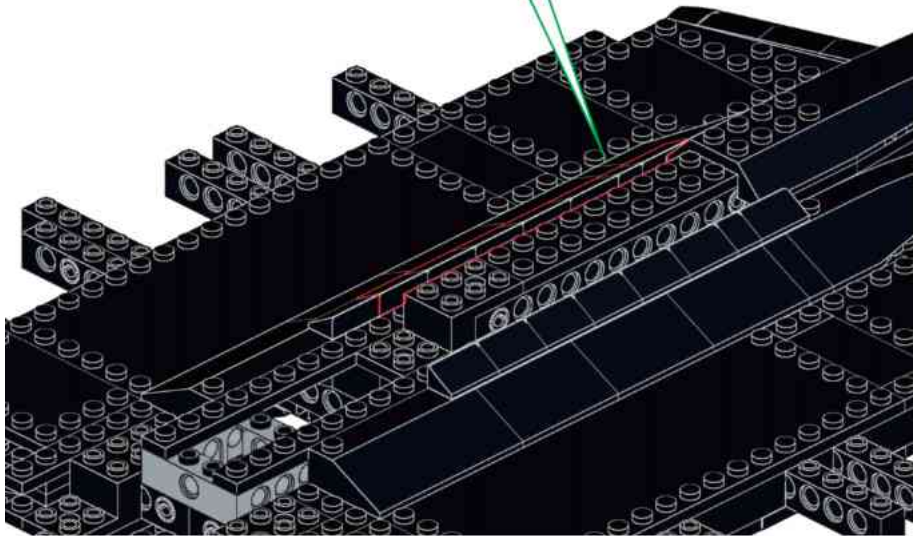
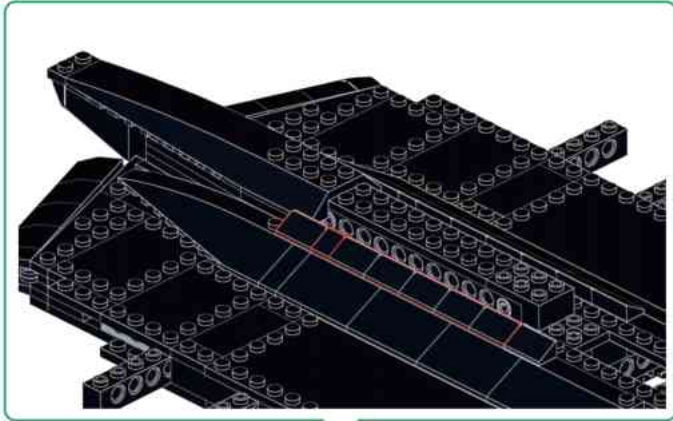

### A106

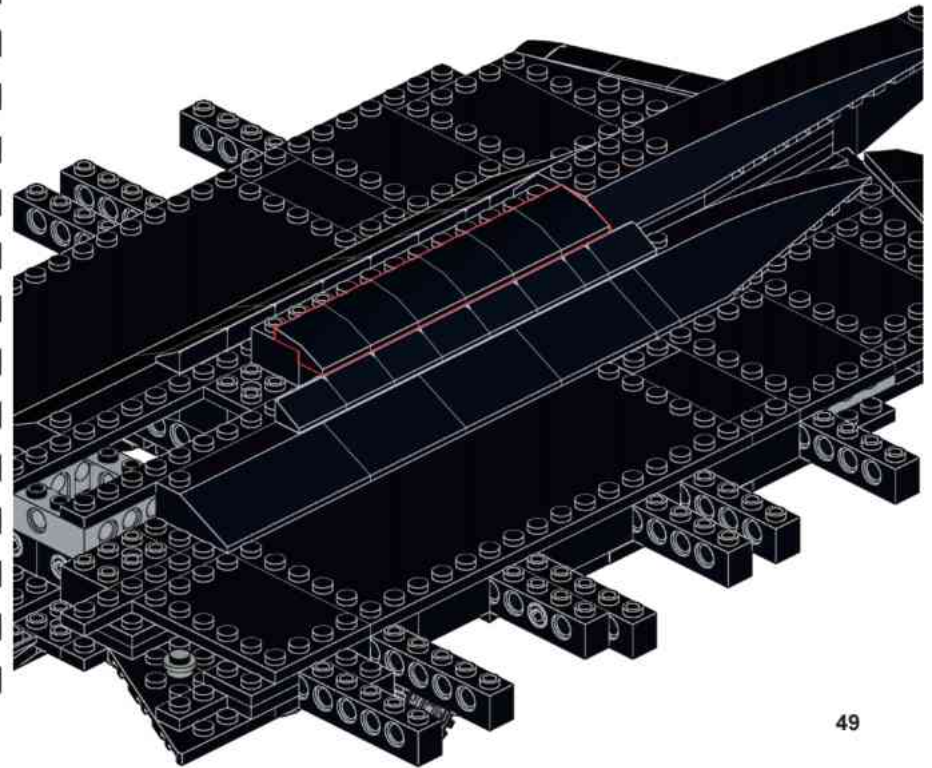



**A107**

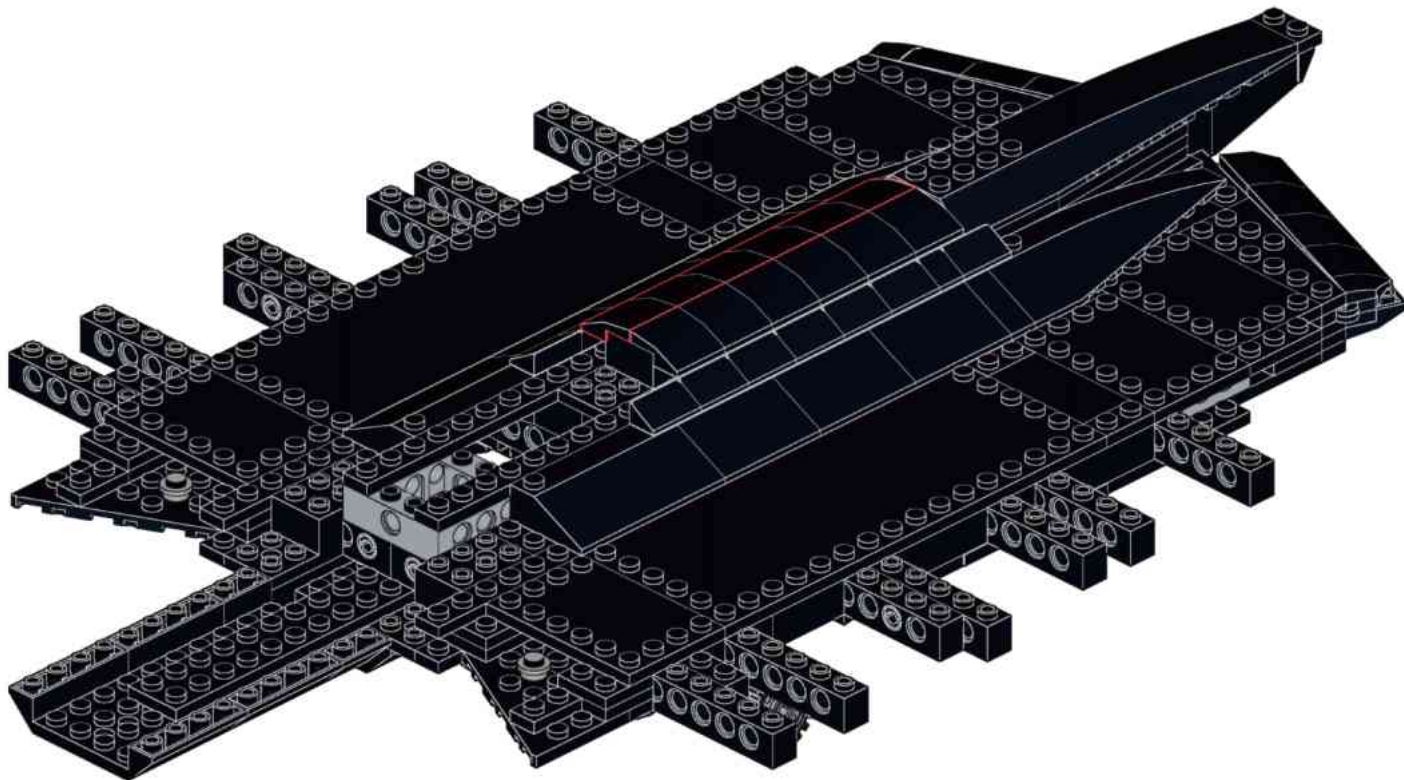



**B**

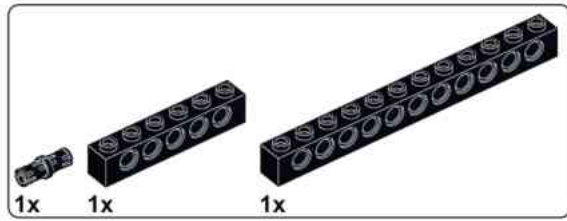

**B1**

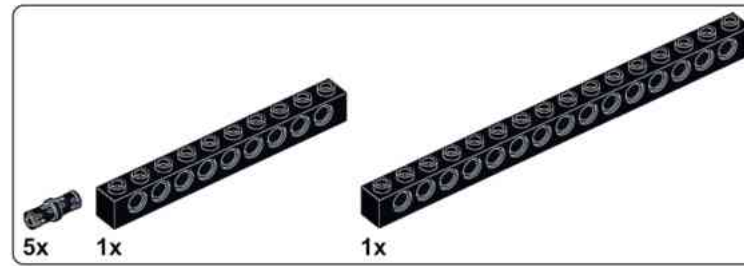
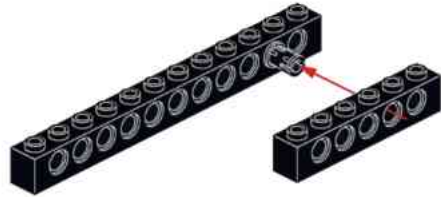

**B2**

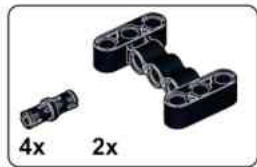

**B3**

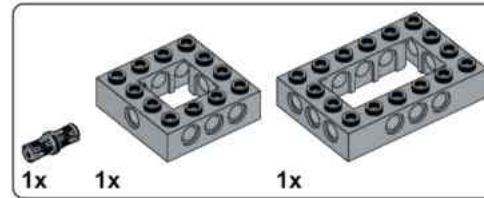
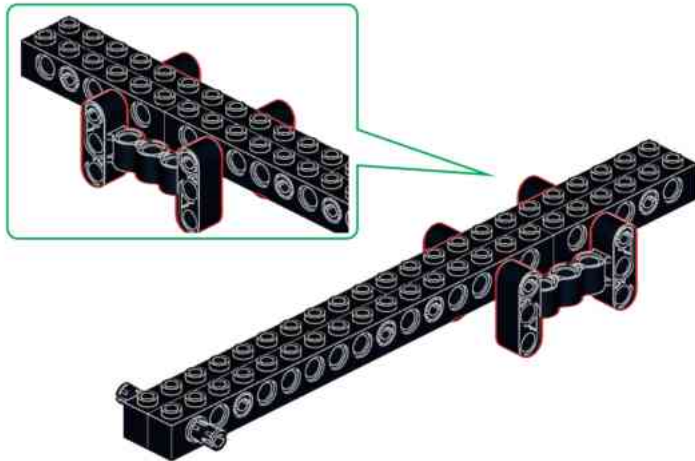

**B4**

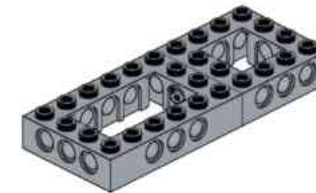

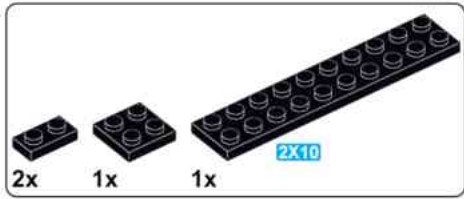

**B5**

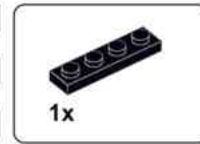
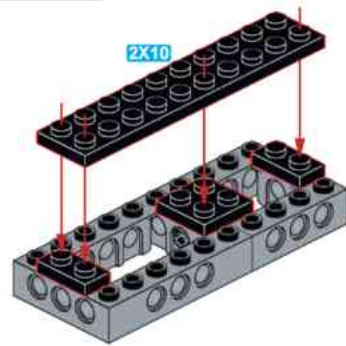

**B6**



**B7**

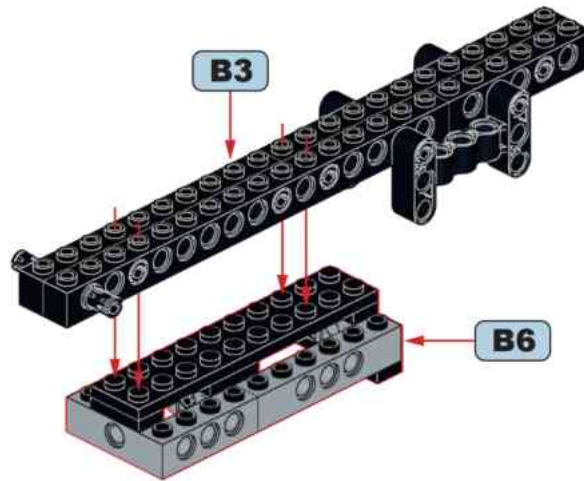

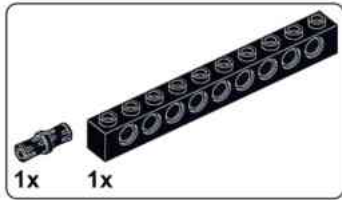

**B8**

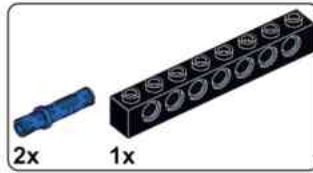

**B9**

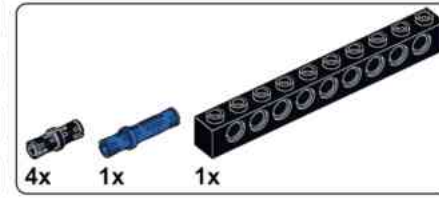

**B10**

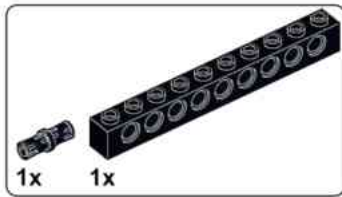

**B11**

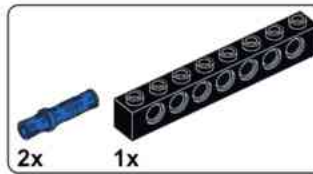

**B12**

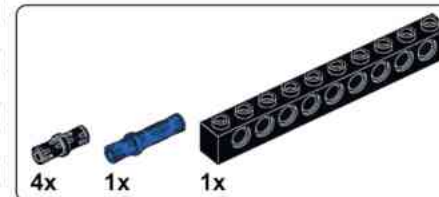

**B13**





**B14**

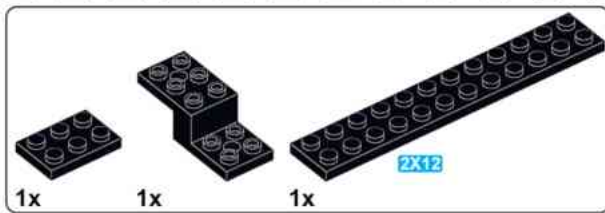
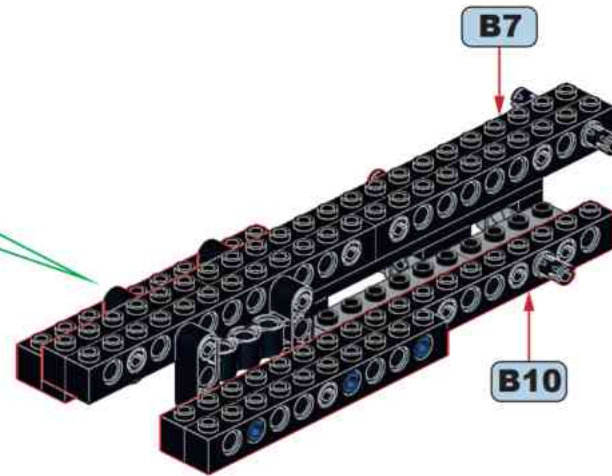
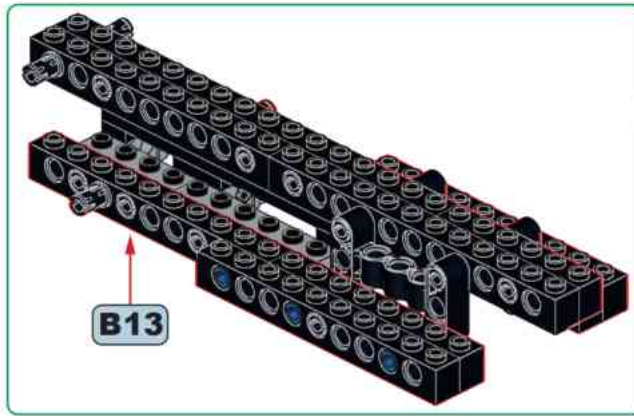

**B15**



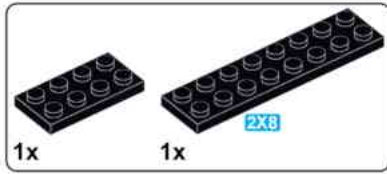

**B16**



**B17**

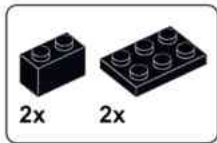

**B18**

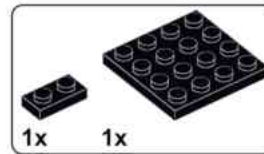
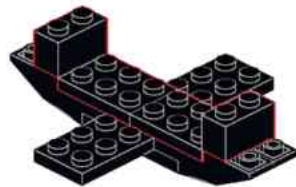

**B19**

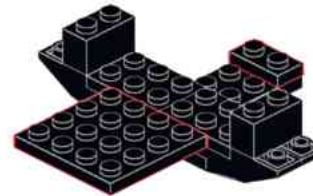

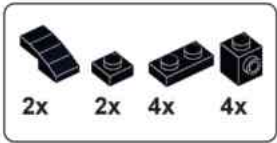

## B20

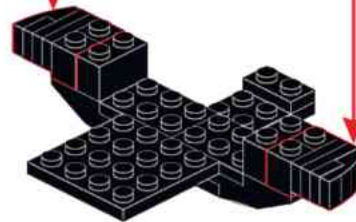
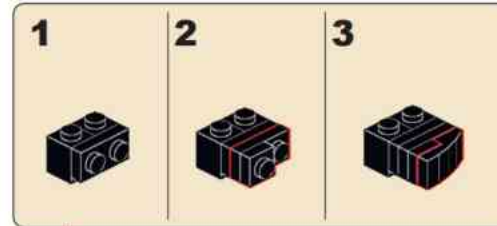
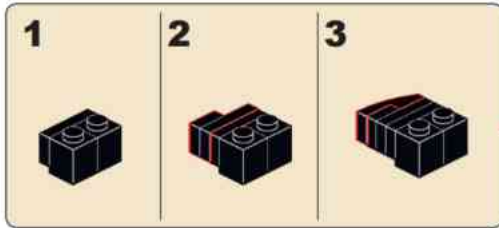

**B21**

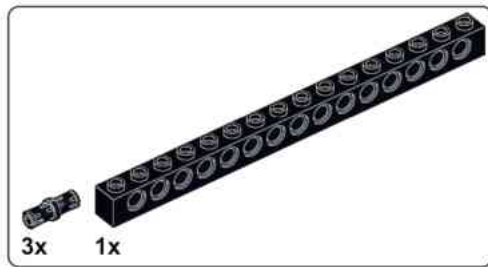
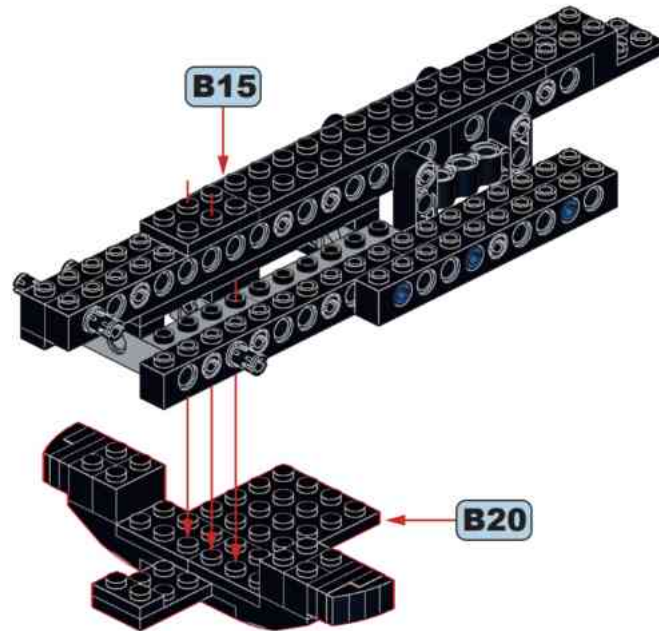

**B22**

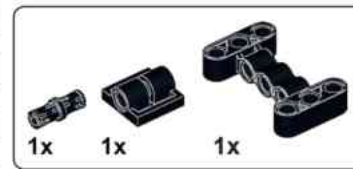

**B23**

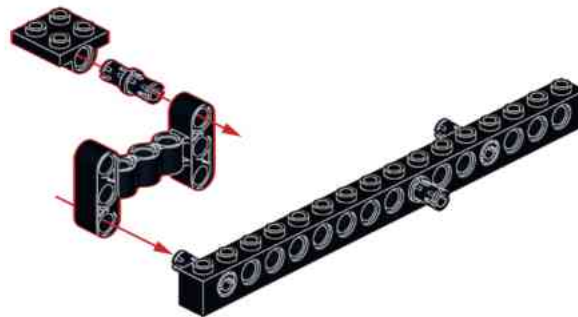

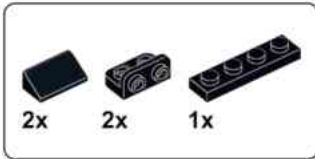

### B24

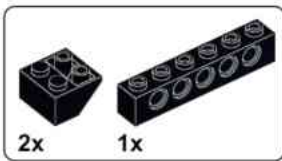
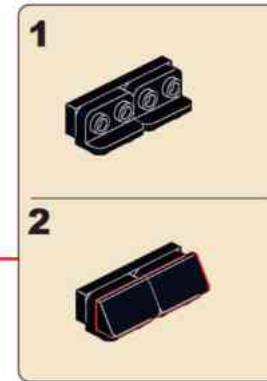
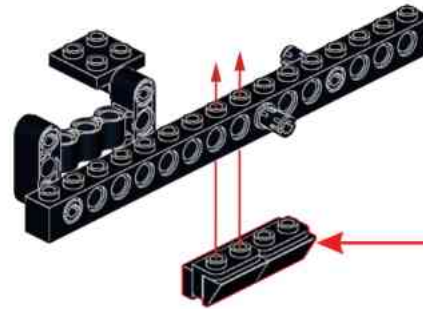

### B25

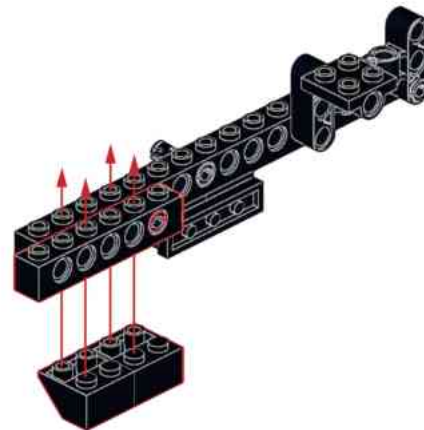

**B26**

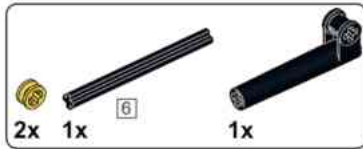
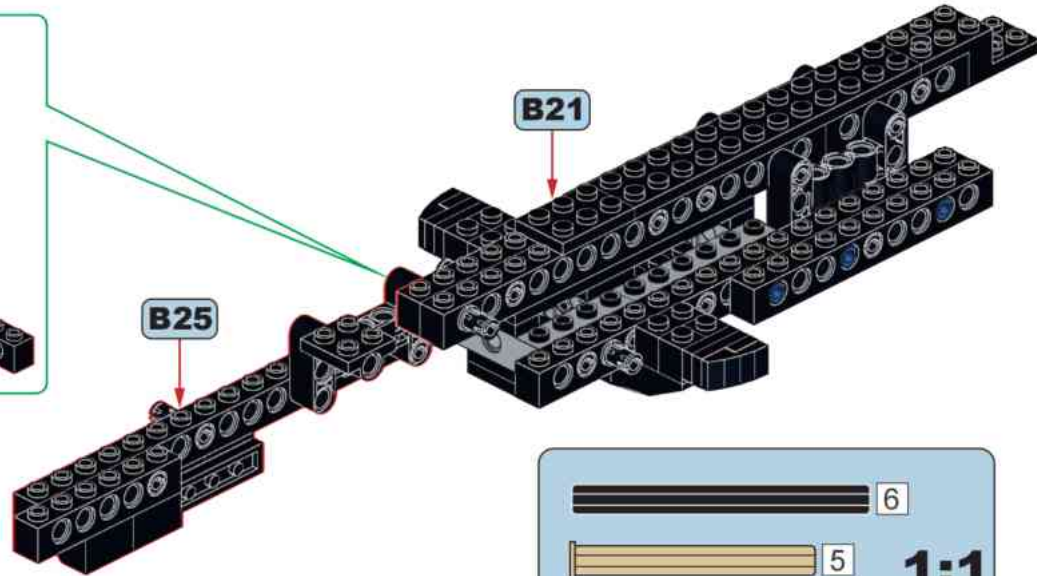
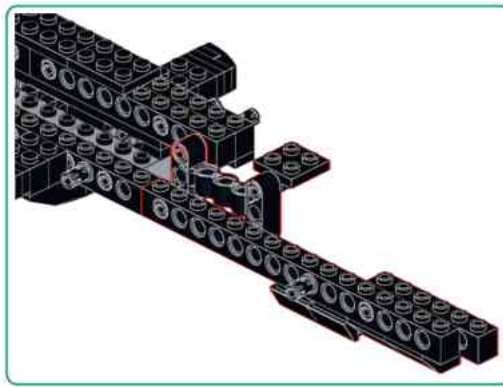

**B27**

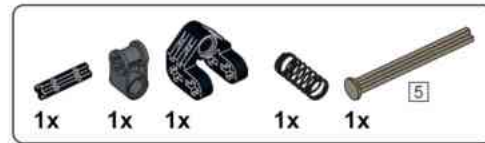
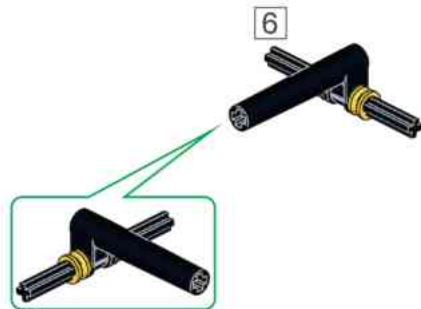

**B28**

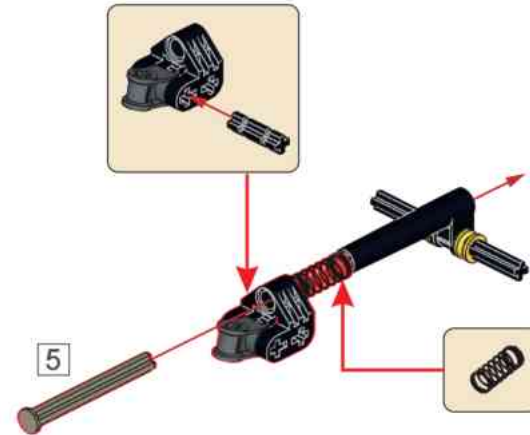

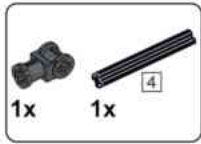

**B29**

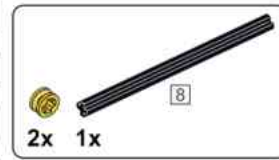

**B30**

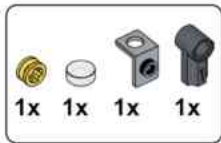
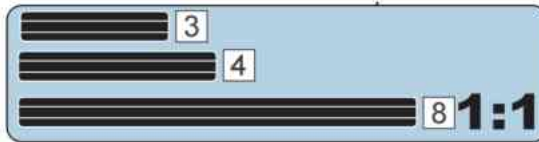

**B31**

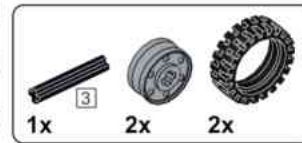

**B32**

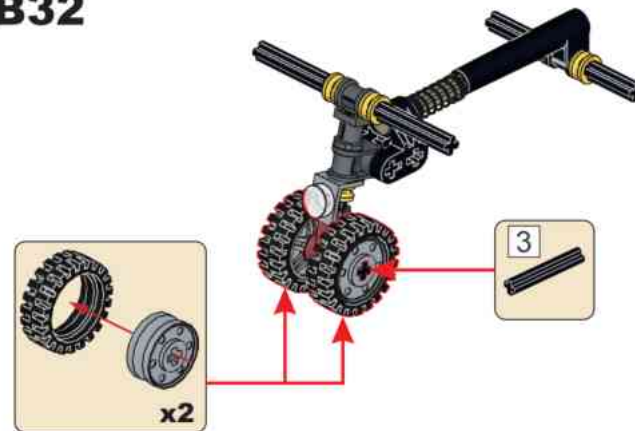

**B33**

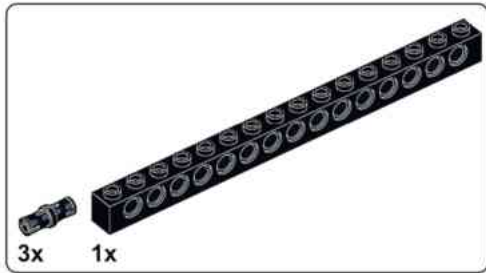
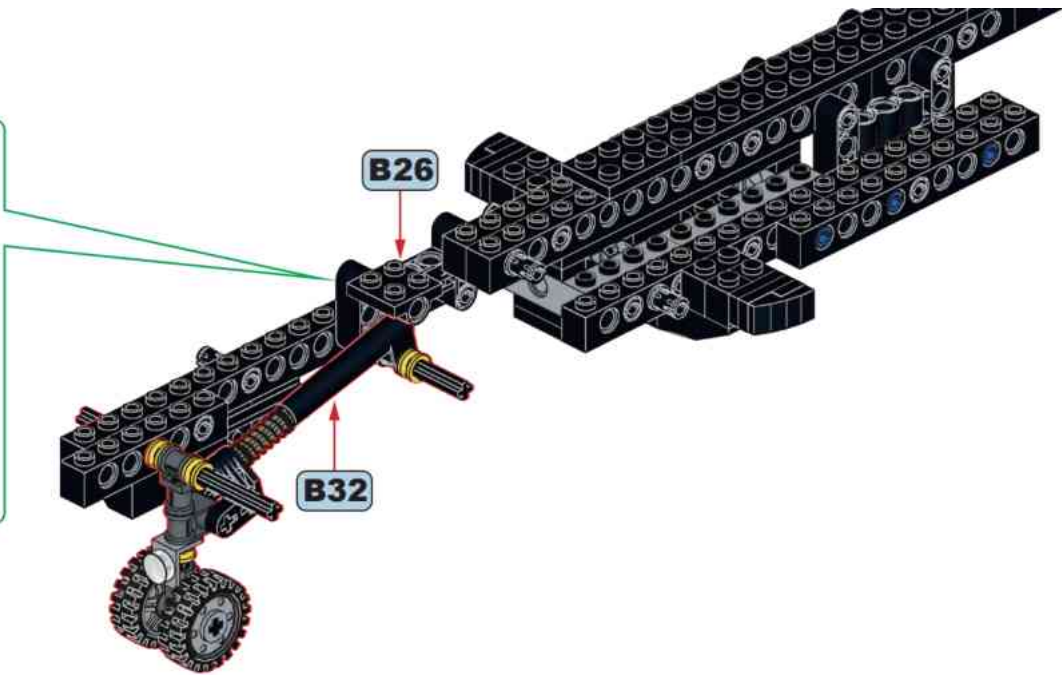
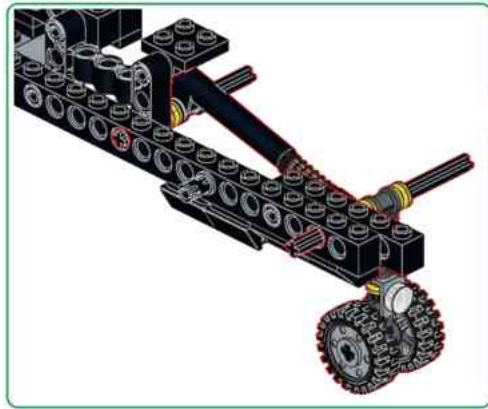

**B34**

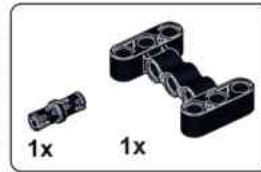

**B35**

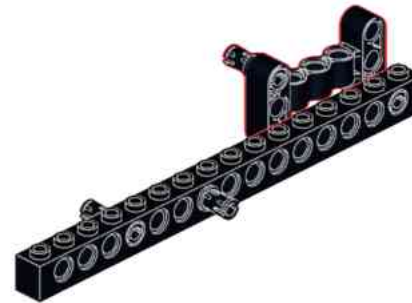

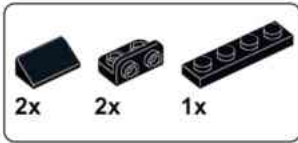

### B36

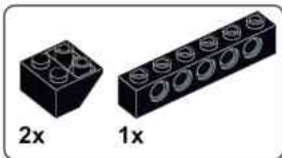
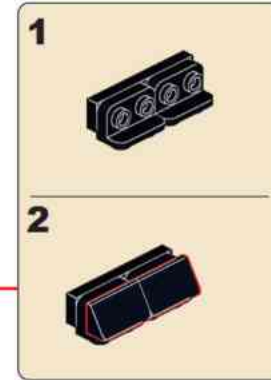
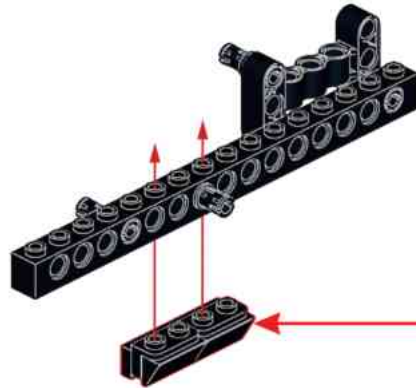

### B37

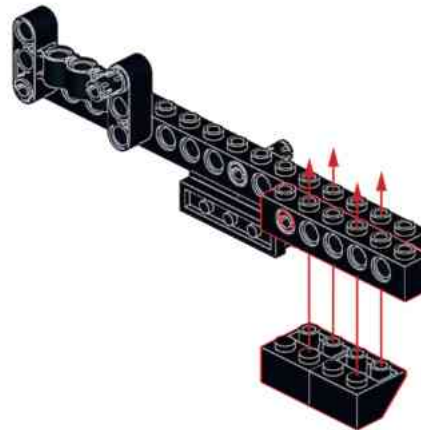

**B38**

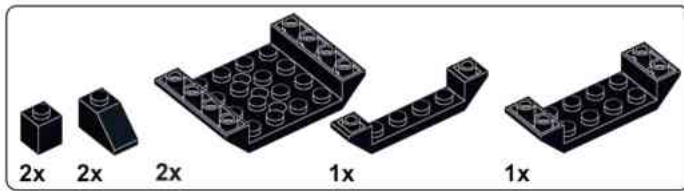
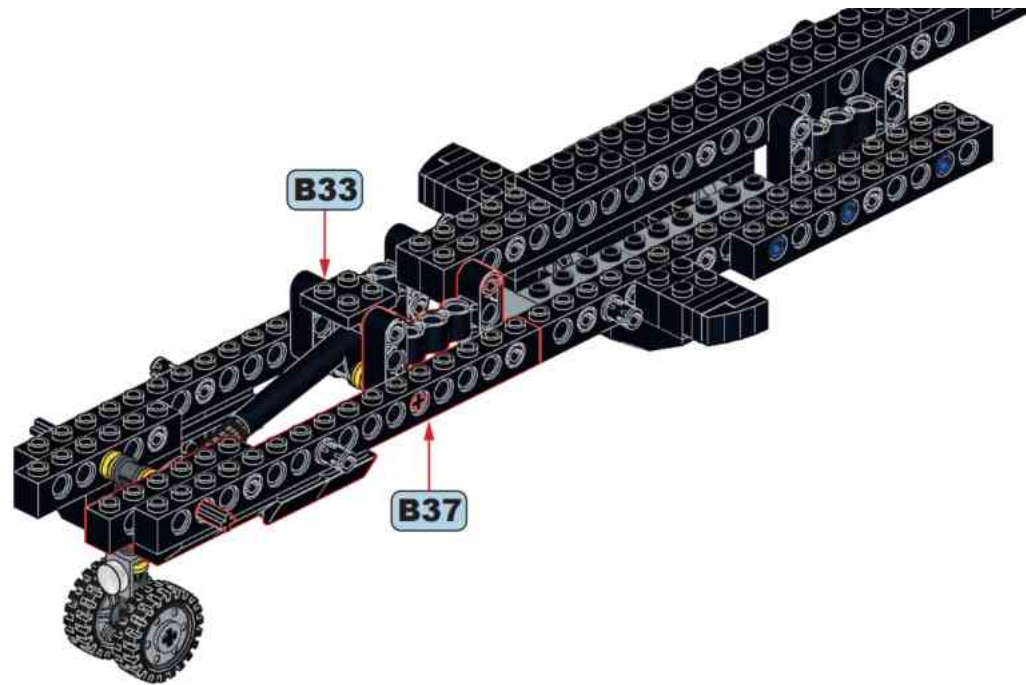

**B39**

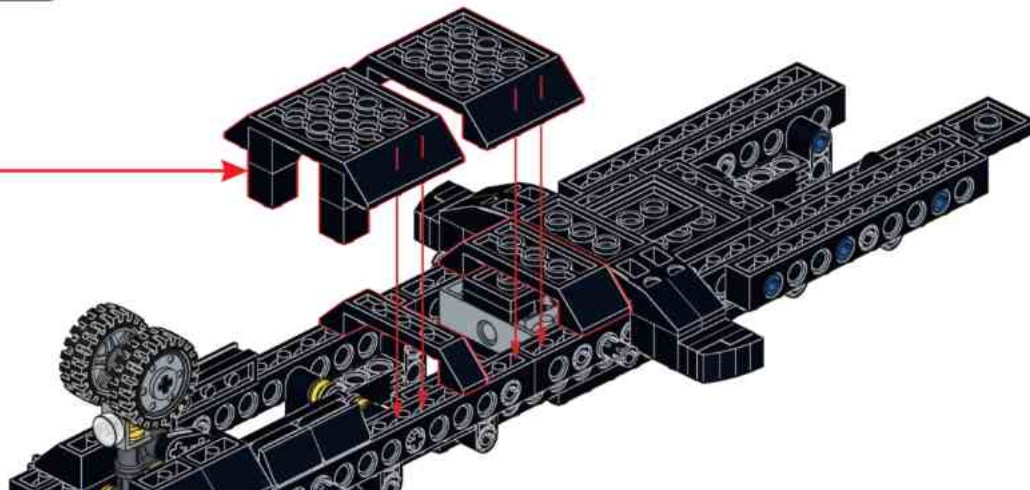
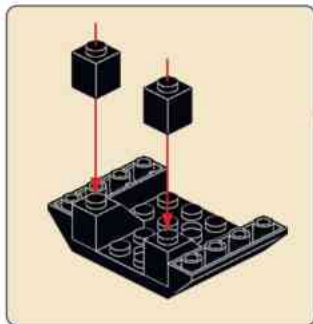

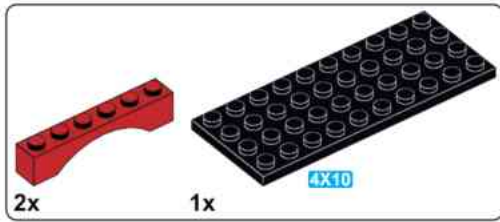

**B40**

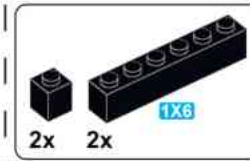
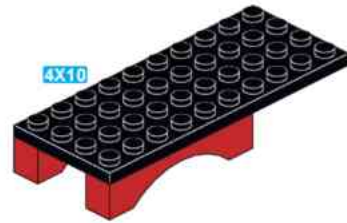

**B41**

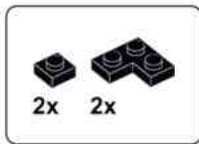
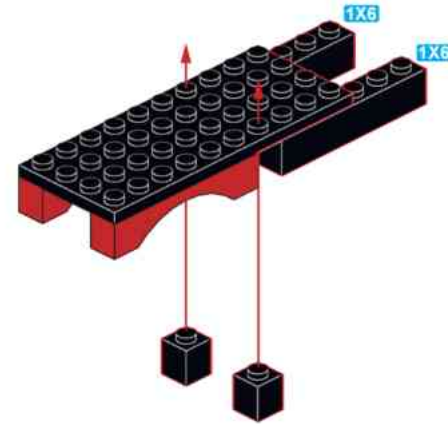

**B42**

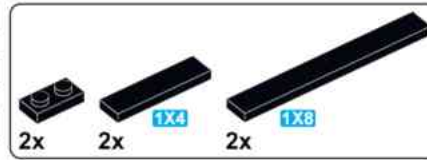
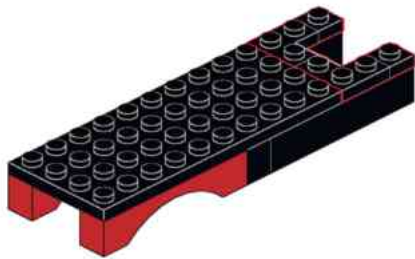

**B43**

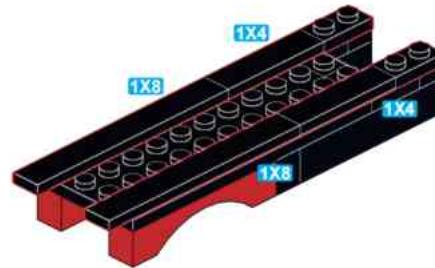

**B44**

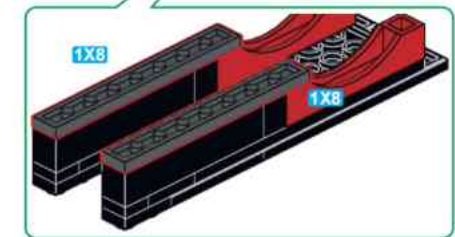
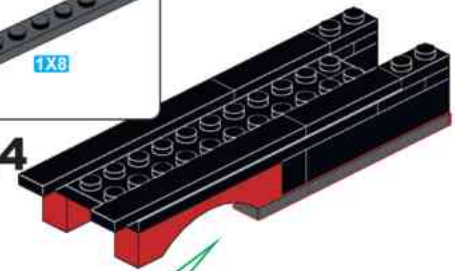

**B45**

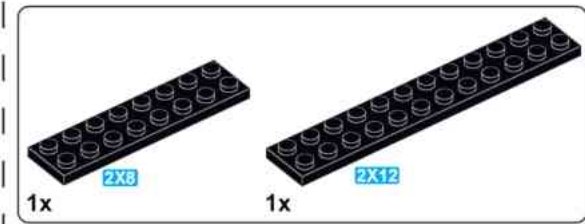
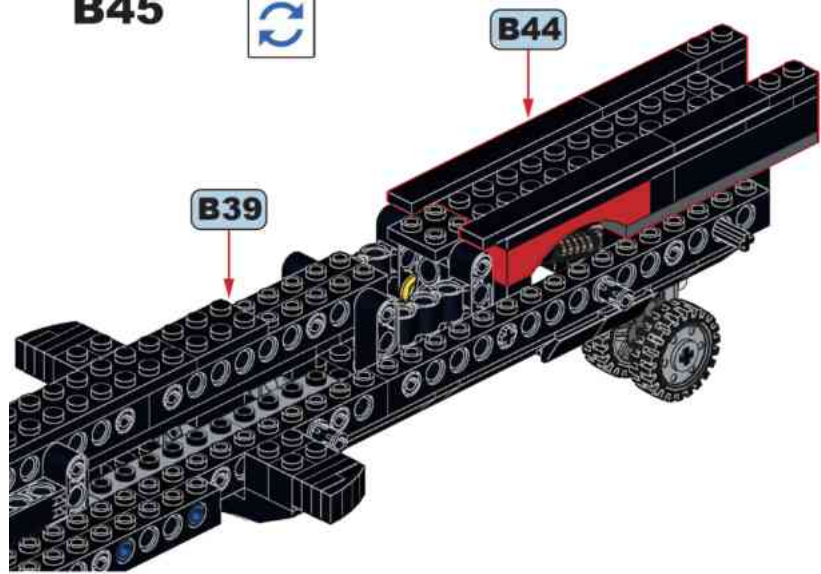

**B46**

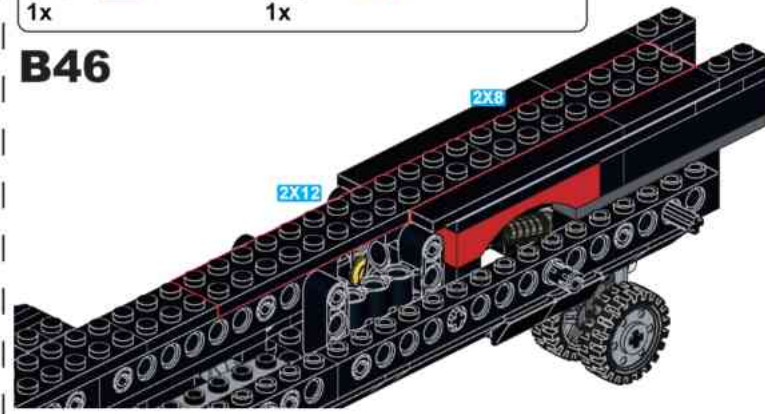

**B47**

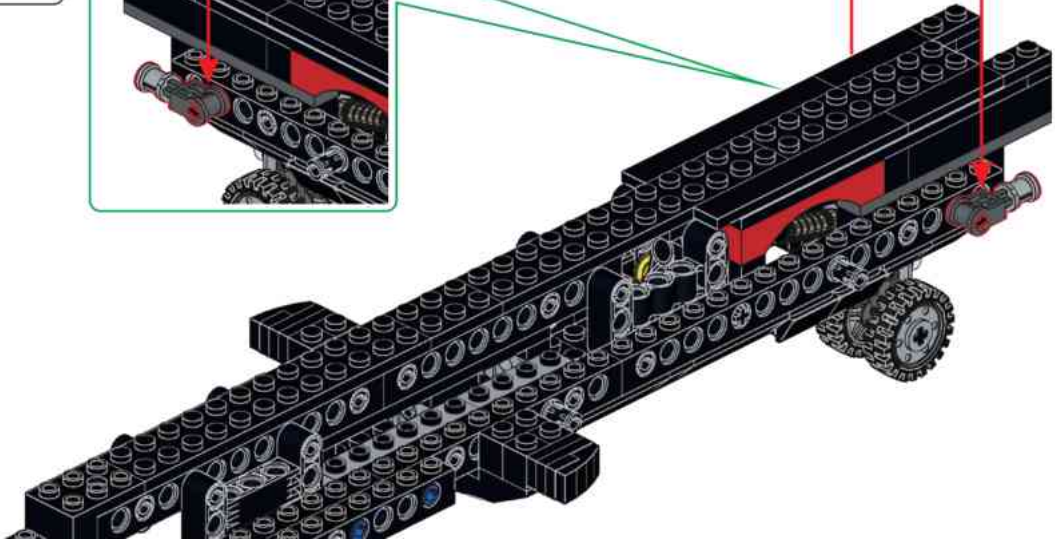
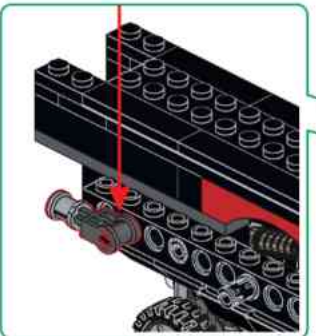

**B48**

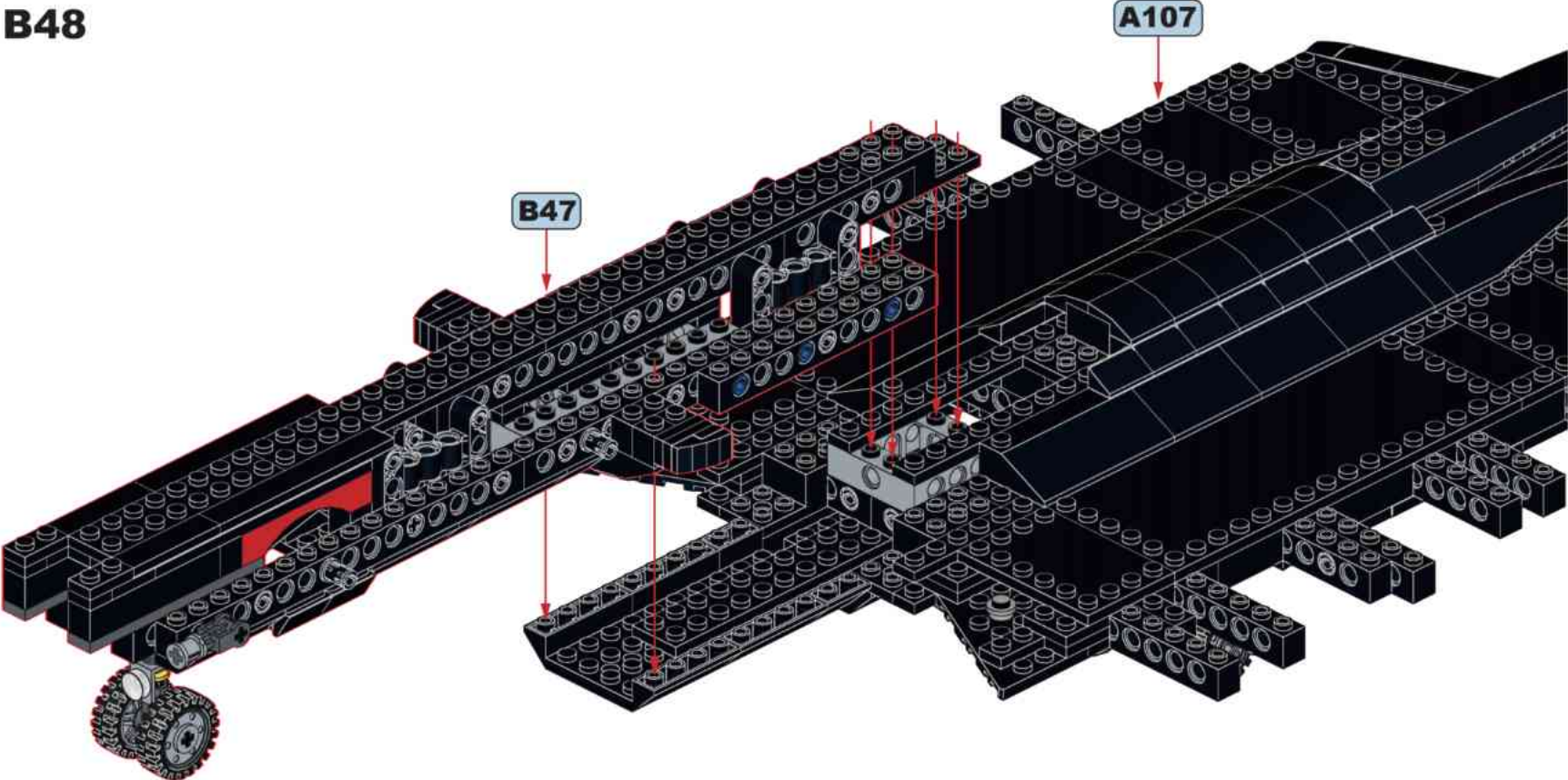

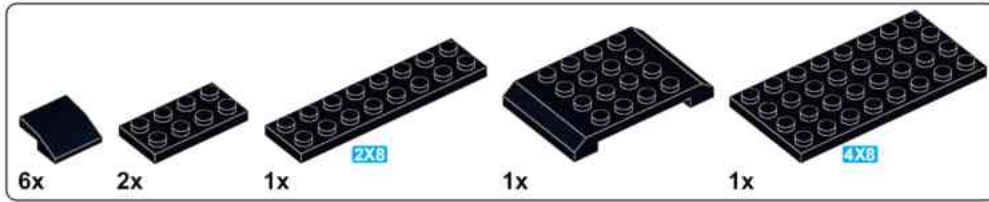

## B49

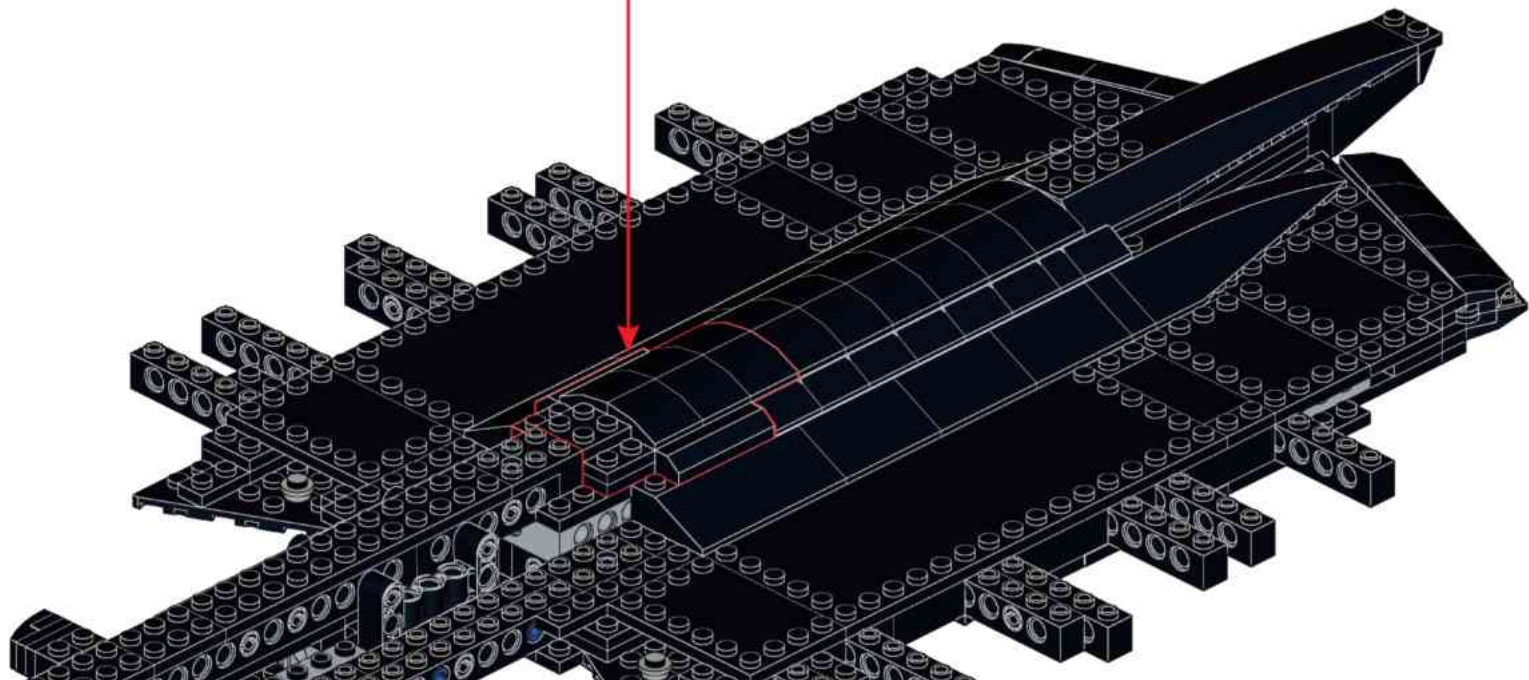
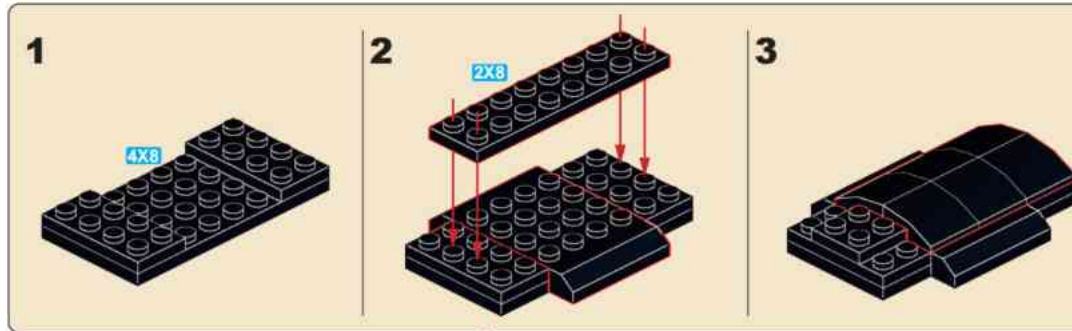

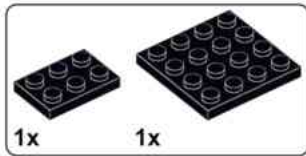

**B50**

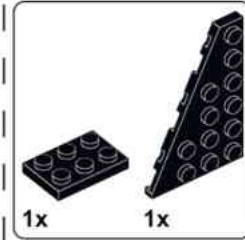
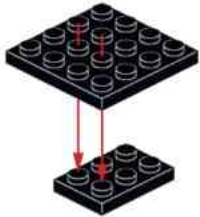

**B51**

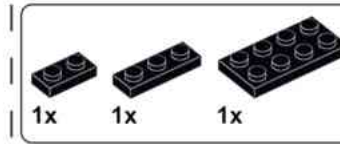
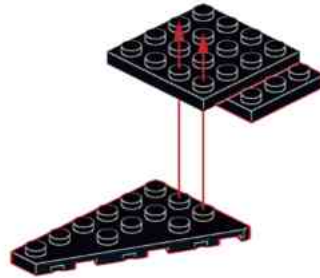

**B52**

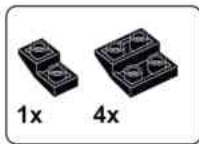
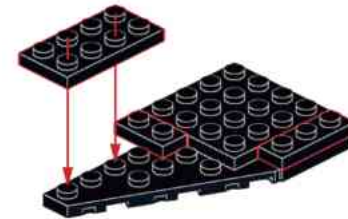

**B53**

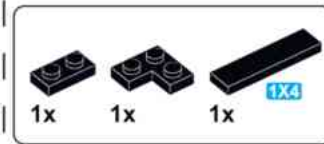

**B54**

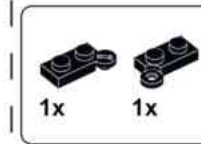

**B55**



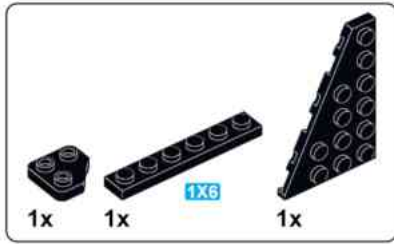

**B56**

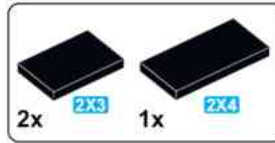

**B57**

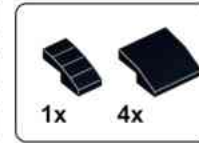
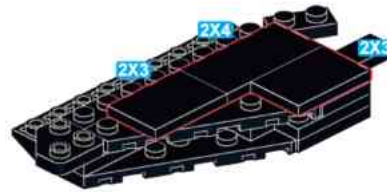

**B58**

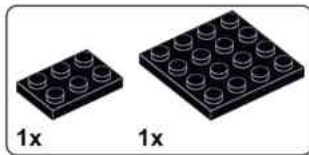
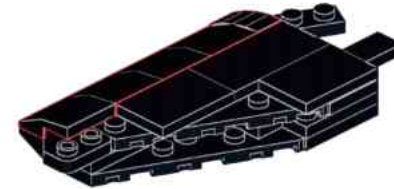

**B59**

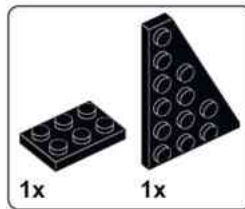
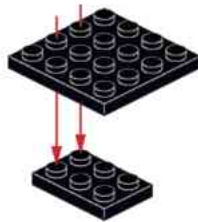

**B60**

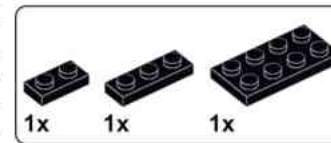
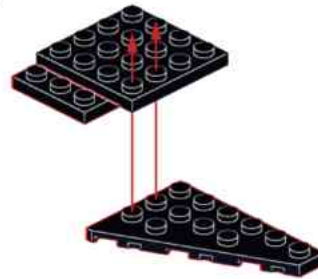

**B61**



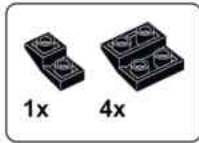

**B62**

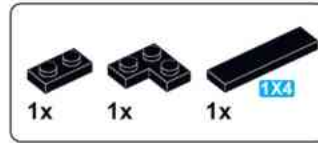
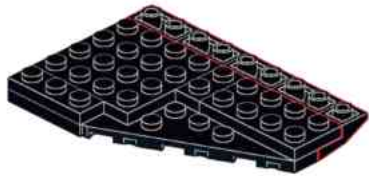

**B63**

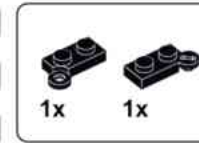

**B64**

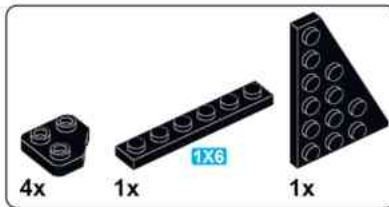
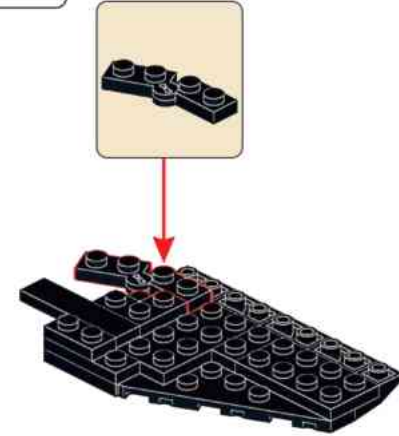

**B65**

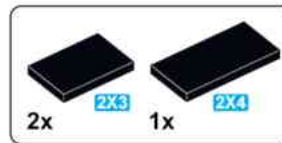

**B66**

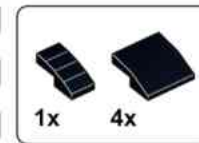
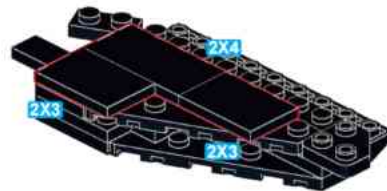

**B67**

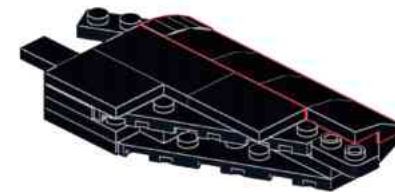

**B68**

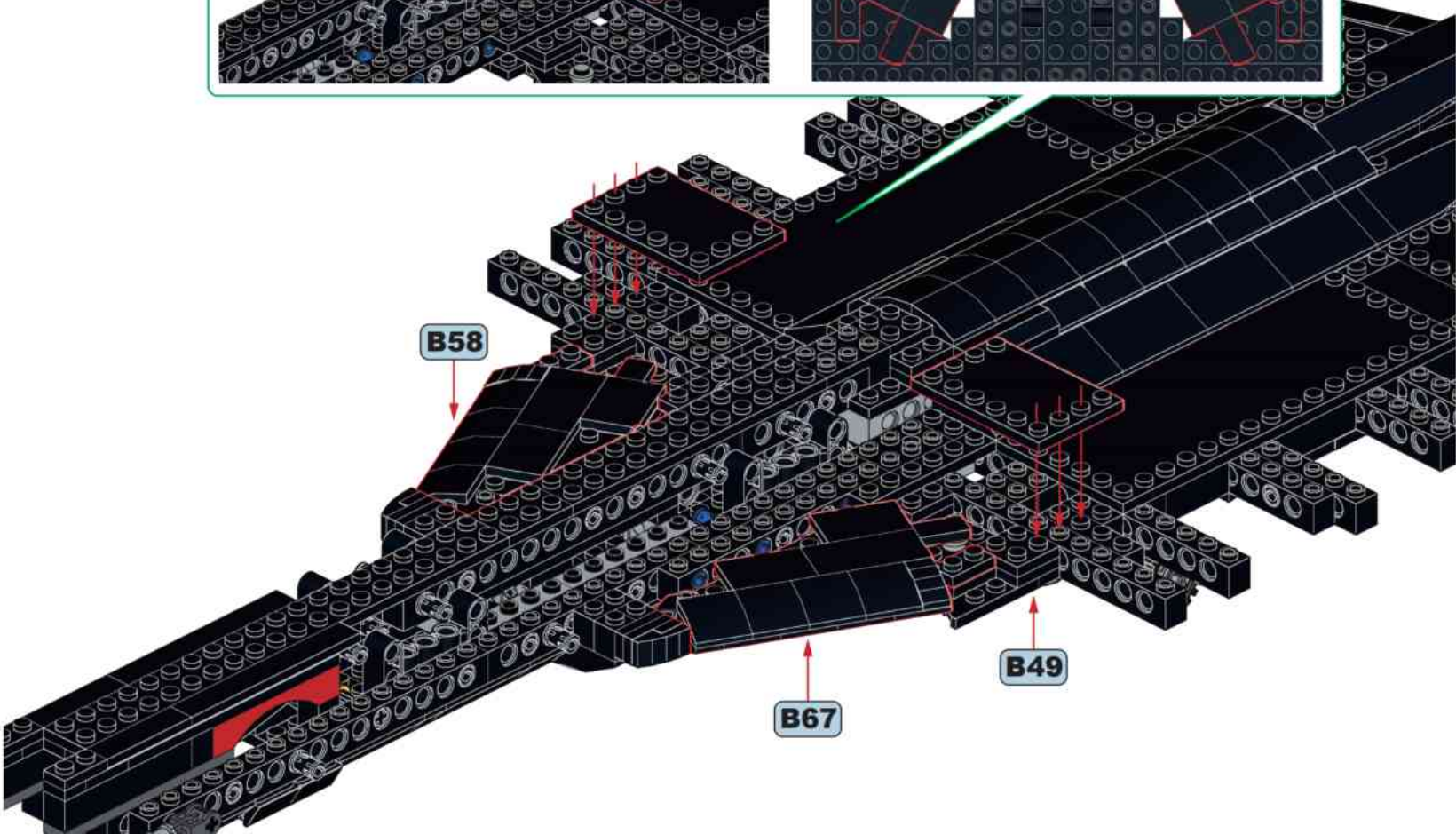
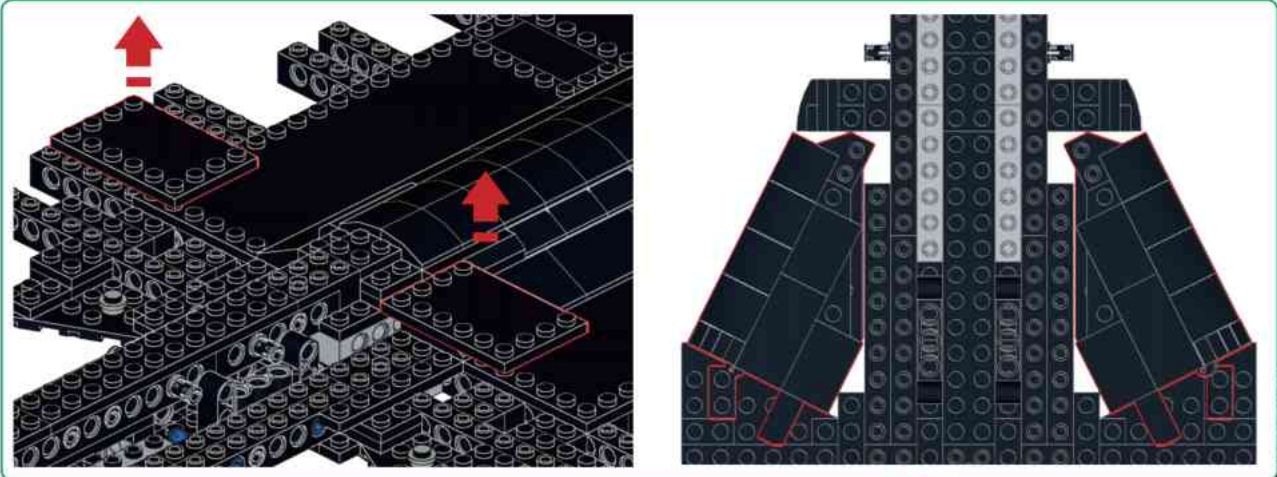

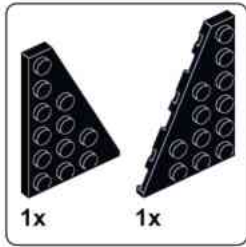

**B69**

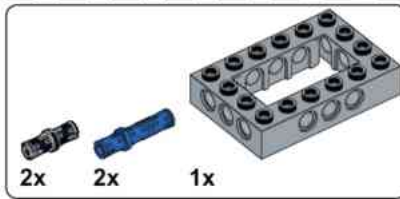
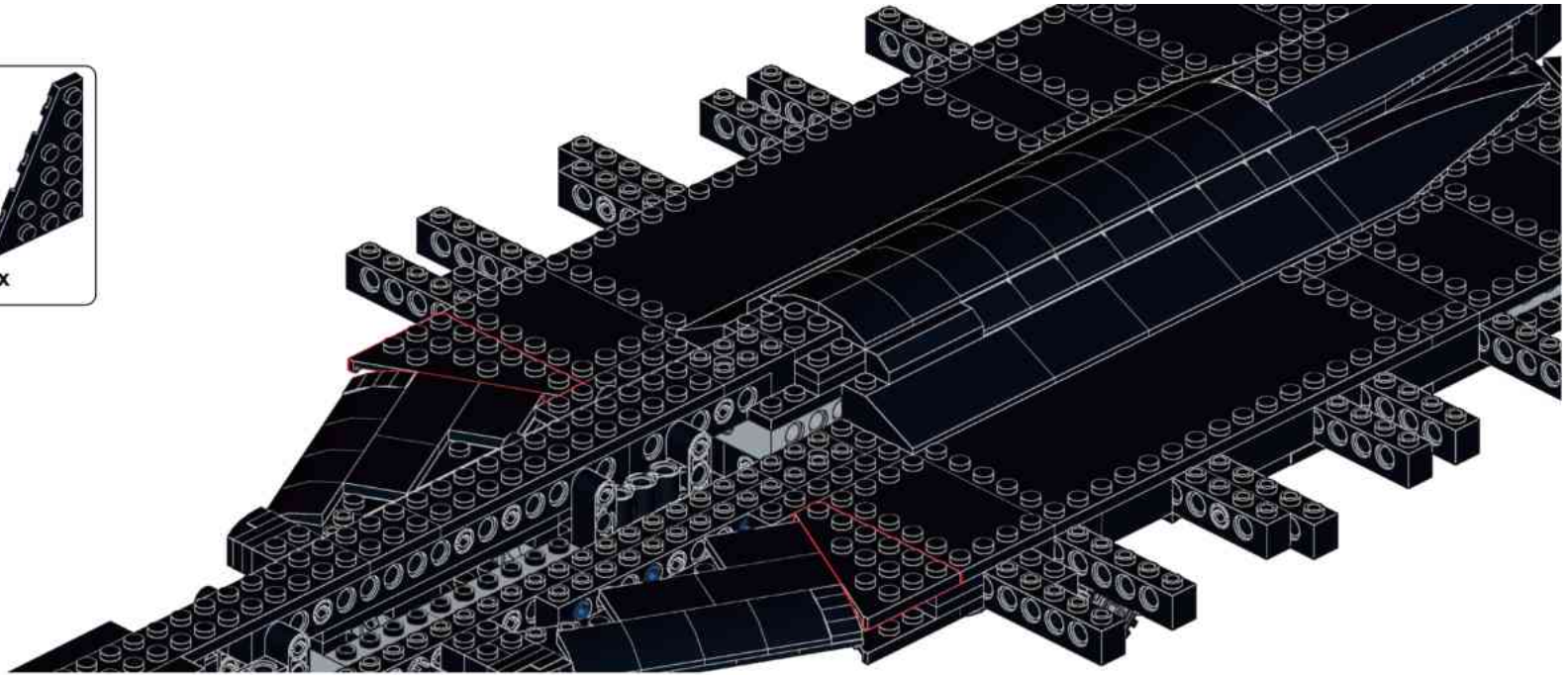

**B70**

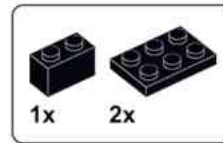
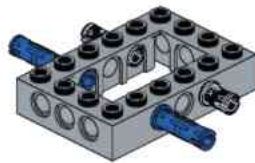

**B71**

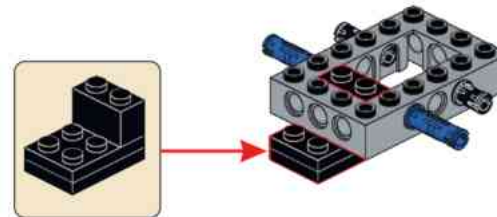

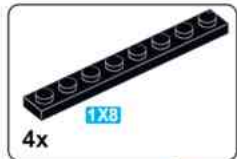

**B72**

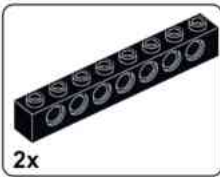
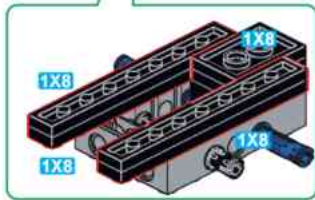
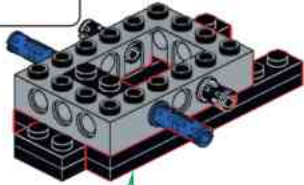

**B73**

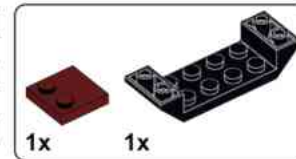

**B74**

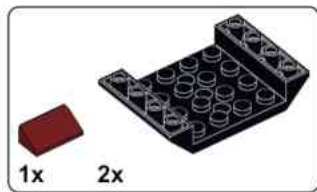
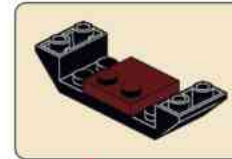

**B75**

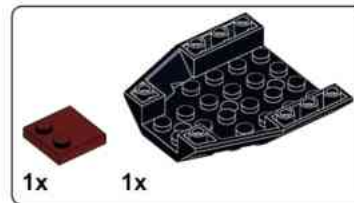
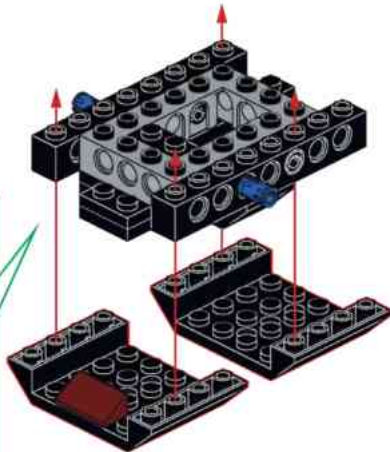
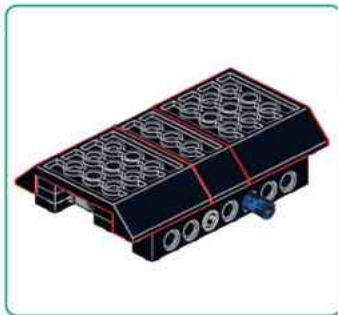

**B76**



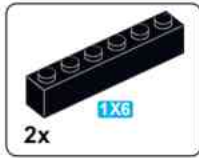

**B77**

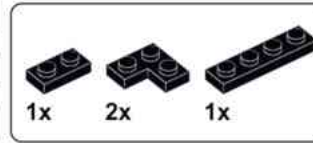

**B78**

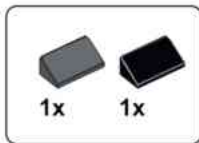
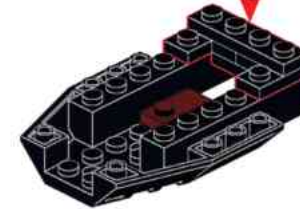
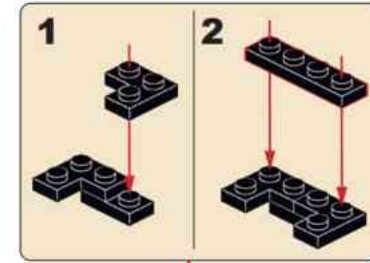

**B79**

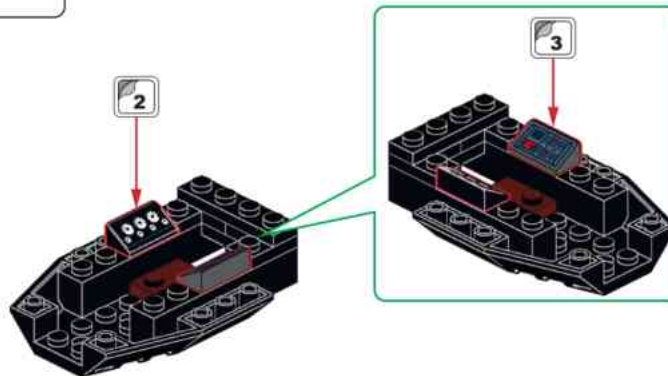

**B80**

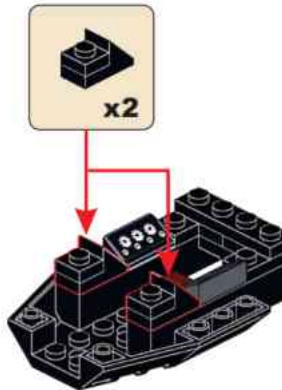

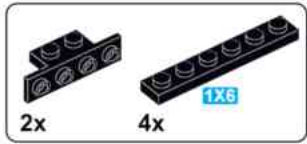

### B81

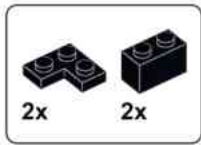
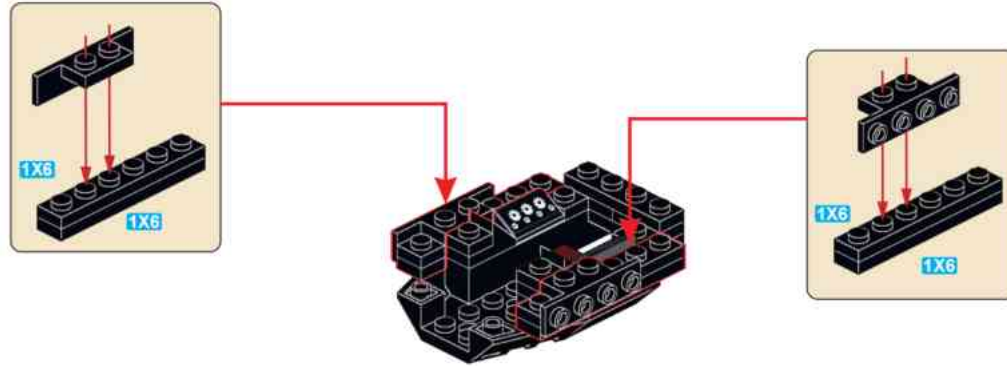

### B82



### B83

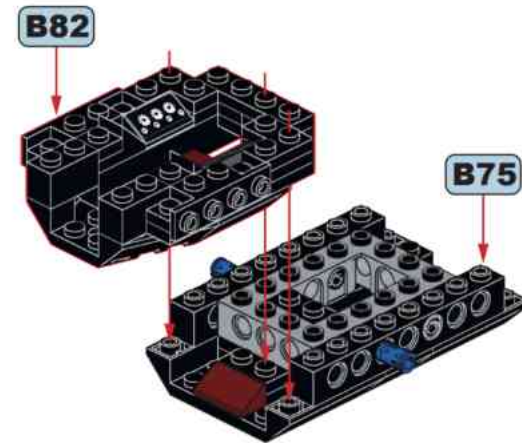

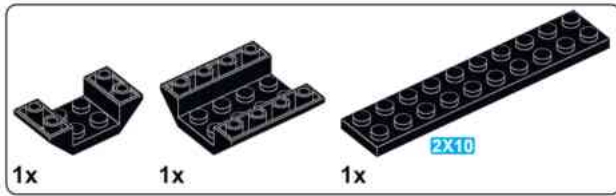

**B84**

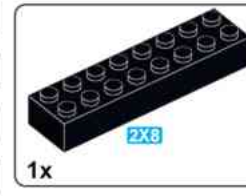
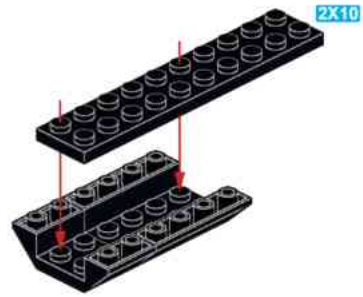

**B85**

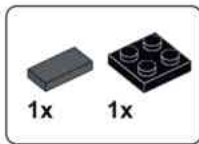
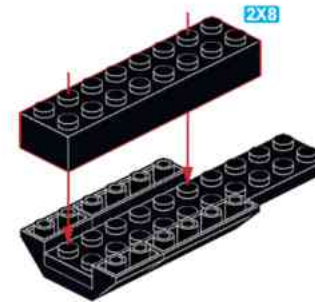

**B86**

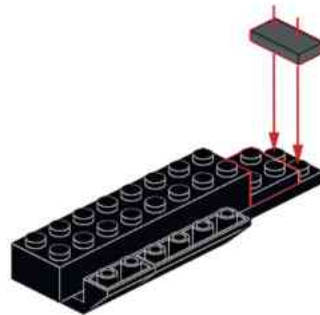

**B87**

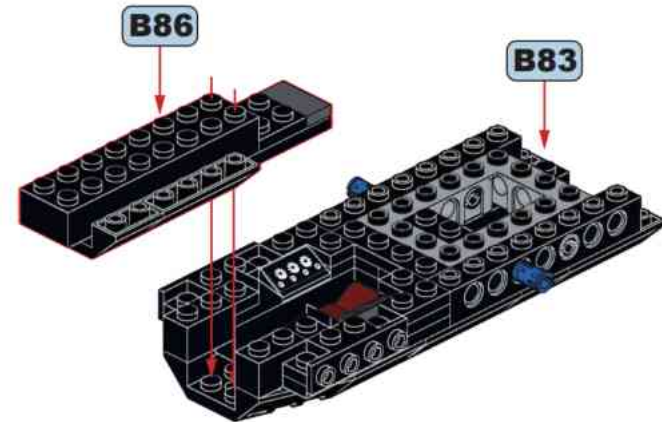

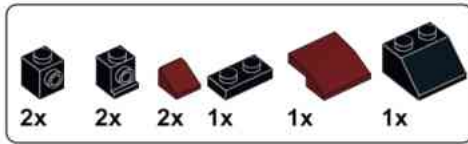

## B88

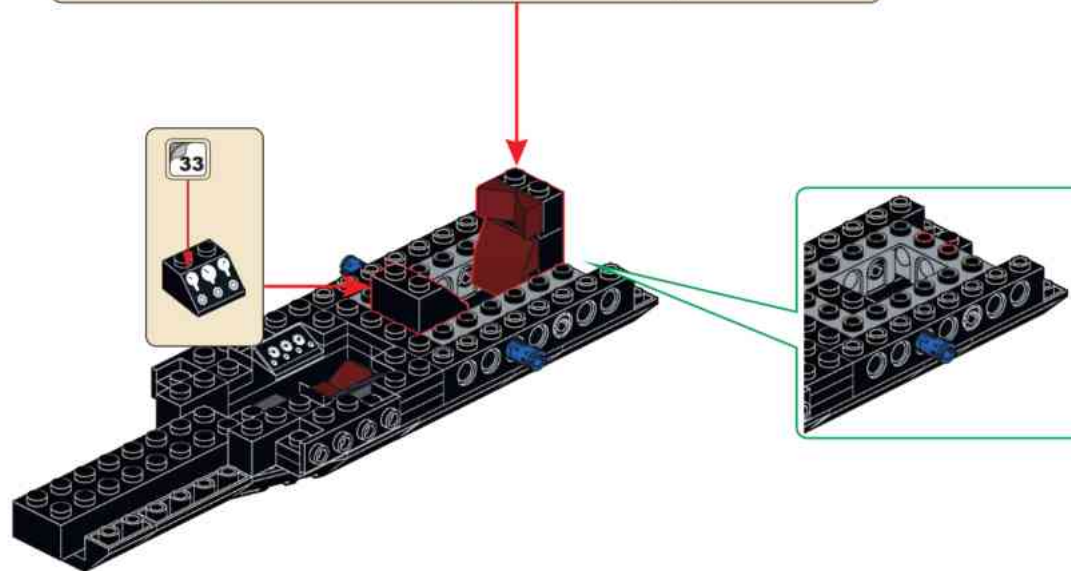
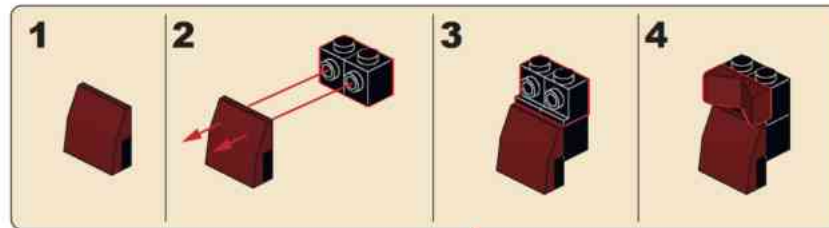

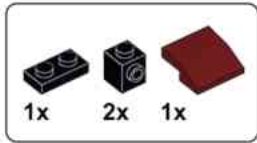

**B89**

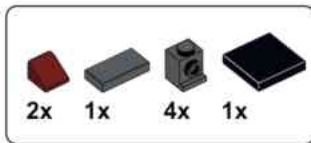
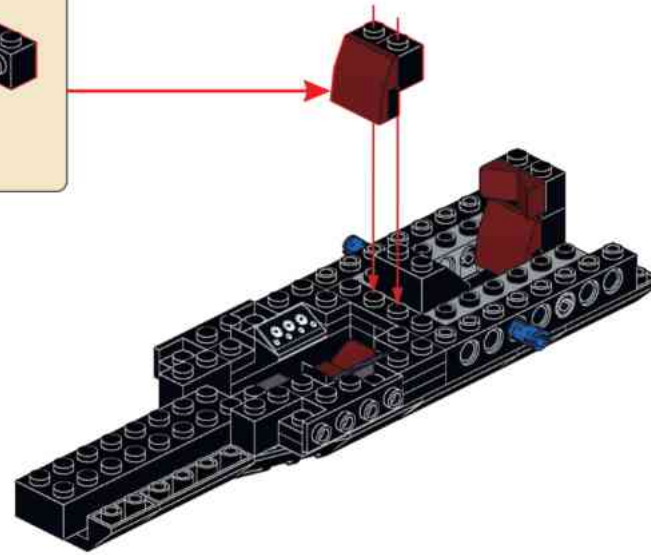
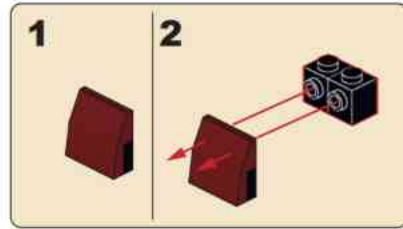

**B90**

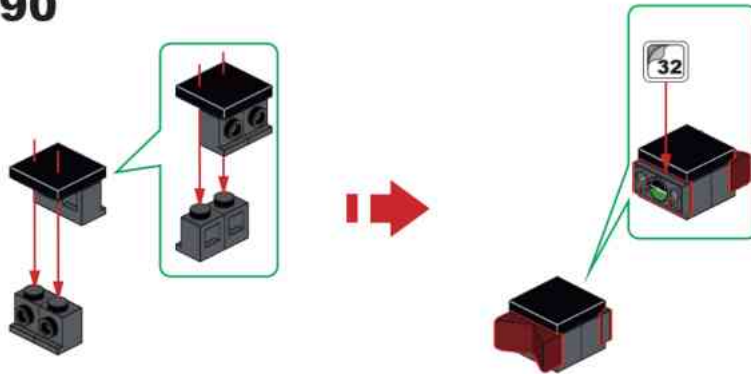

**B91**

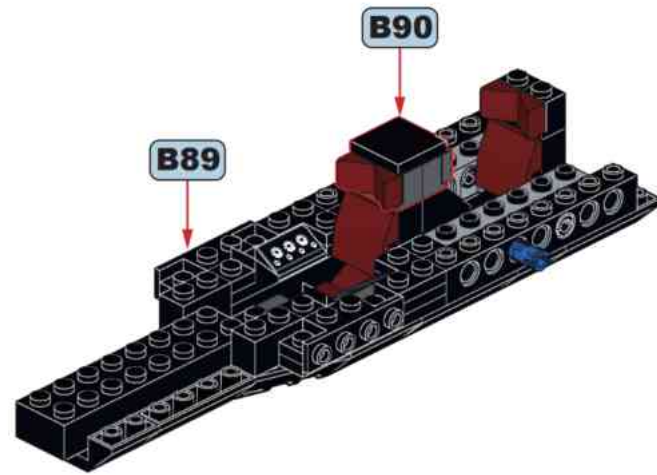

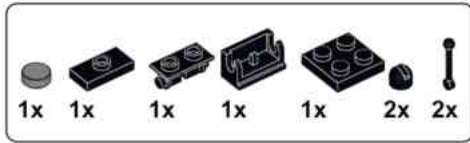

## B92

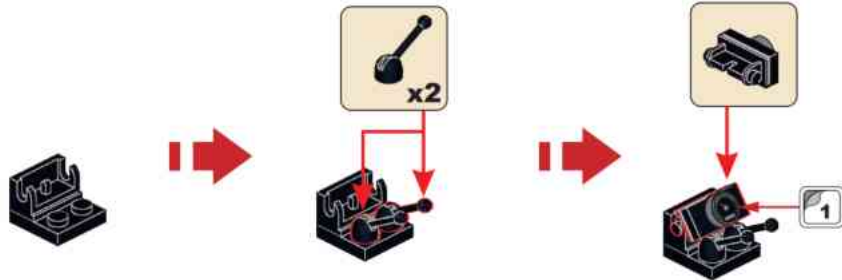

## B93

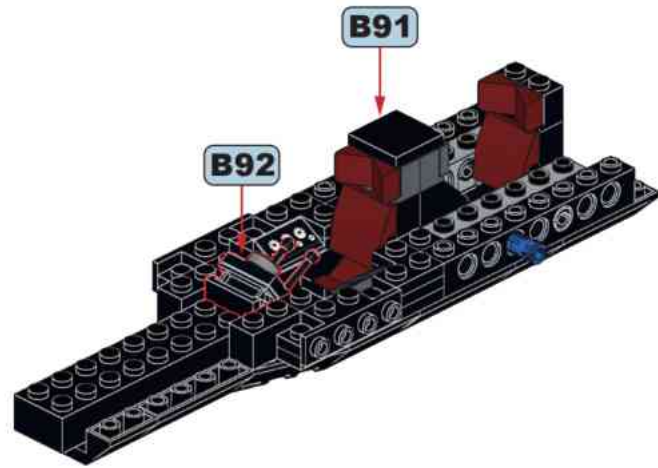

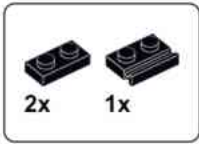

**B94**

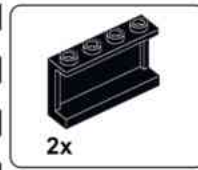
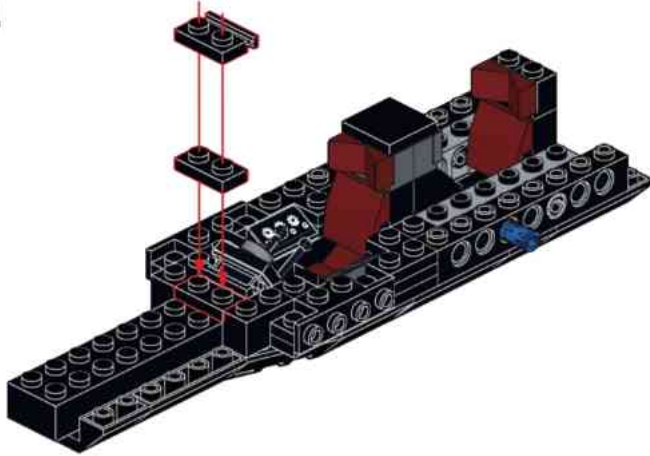

**B95**

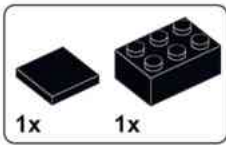
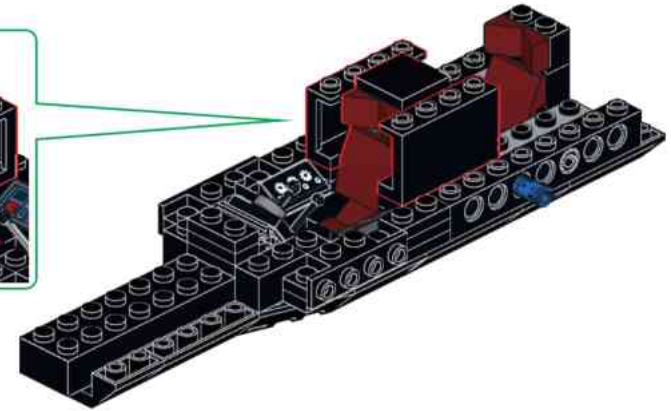
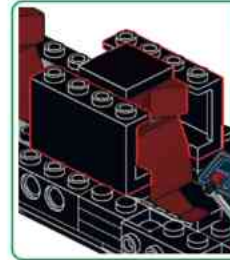

**B96**

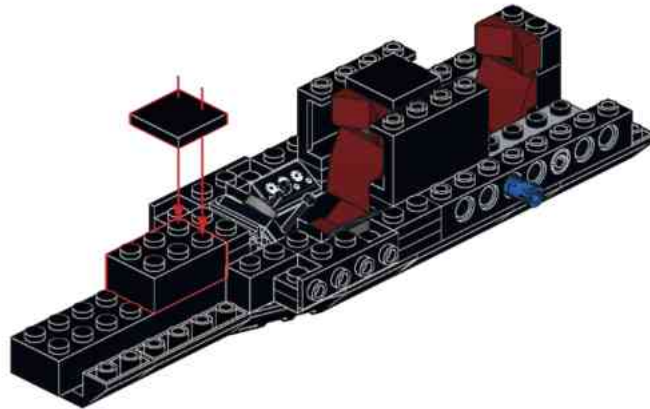

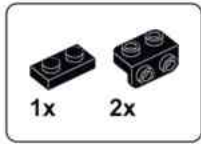

**B97**

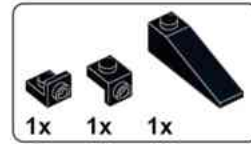

**B98**

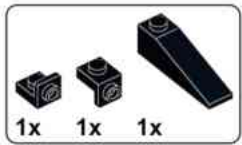
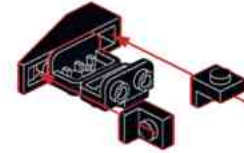

**B99**

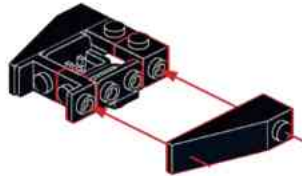

**B100**

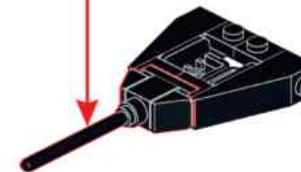
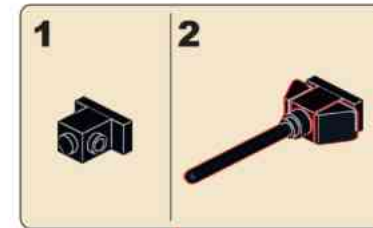

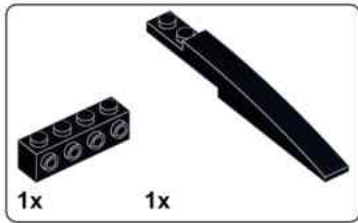

**B101**

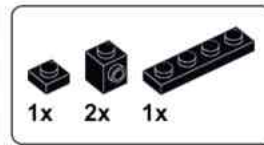
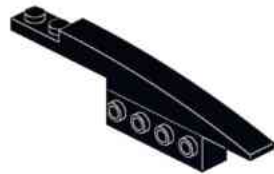

**B102**

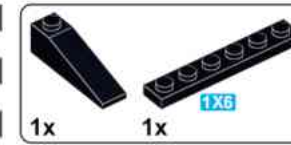
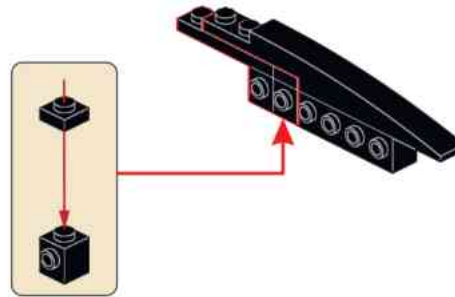

**B103**

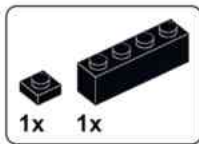
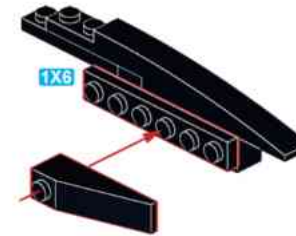

**B104**

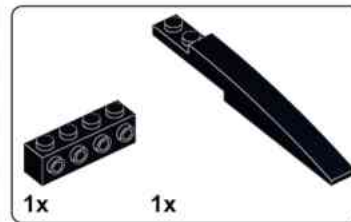
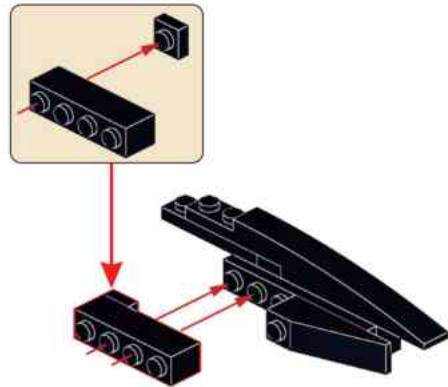

**B105**

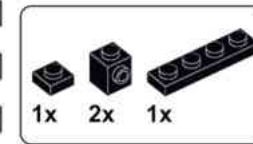

**B106**

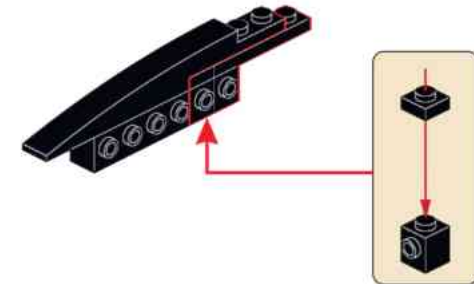

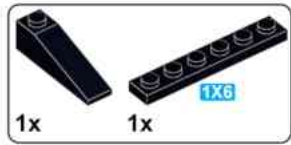

**B107**

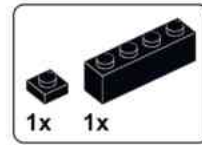
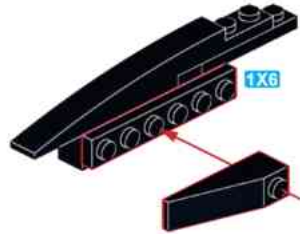

**B108**

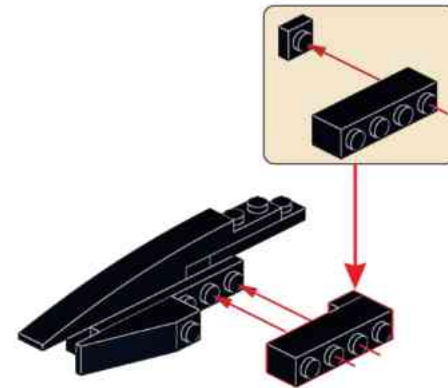

**B109**

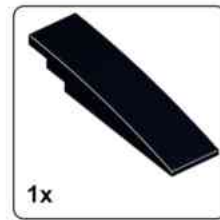
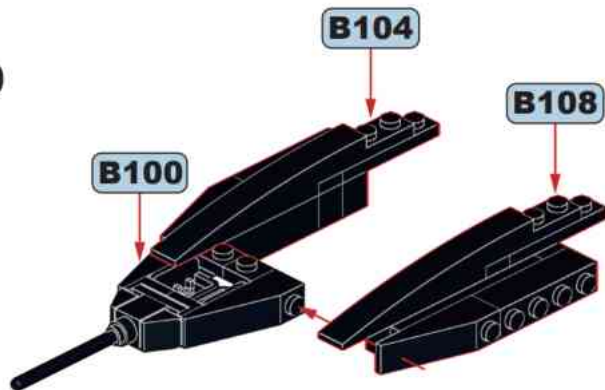

**B110**

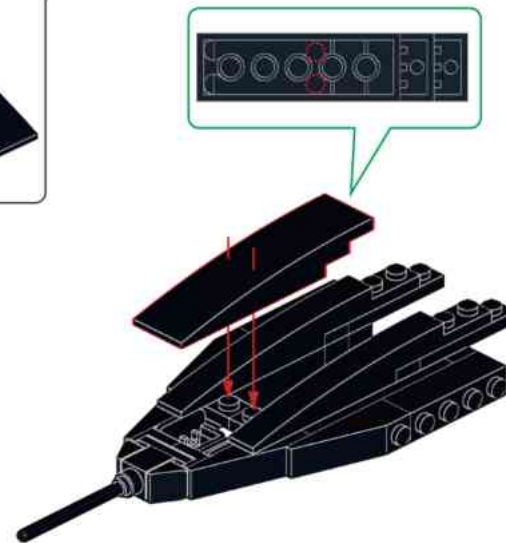



**B111**

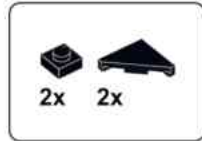
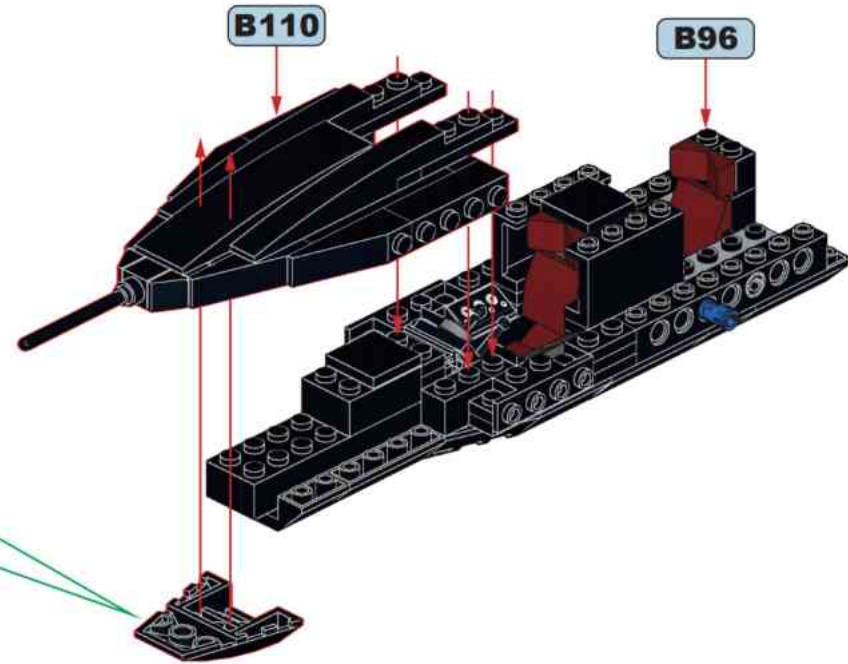
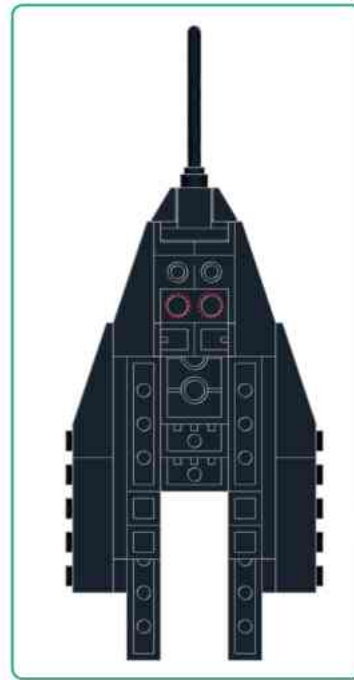

**B112**

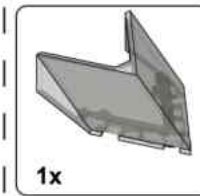
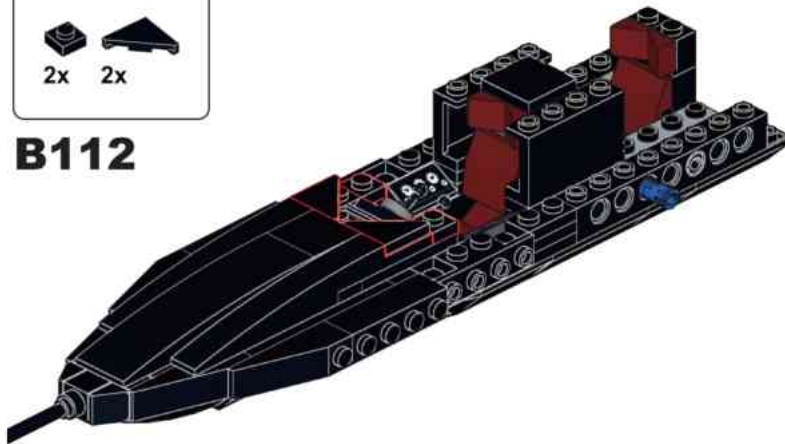

**B113**

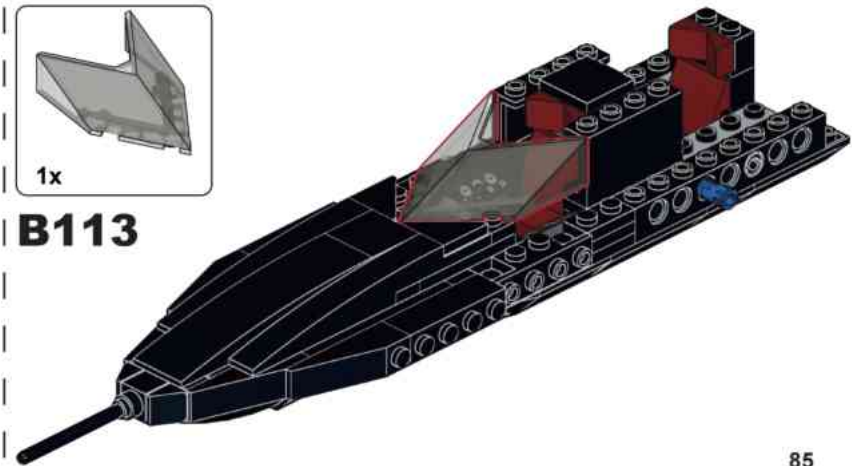

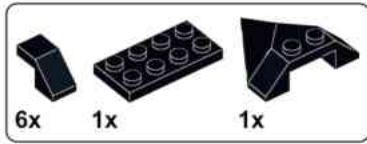

### B114

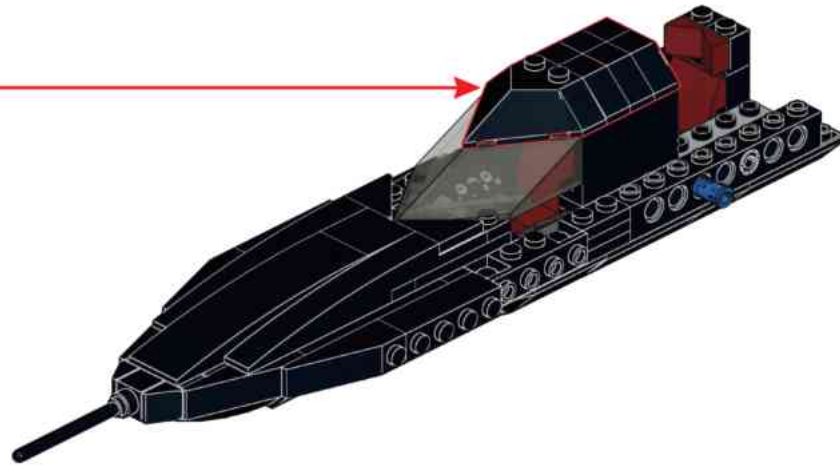
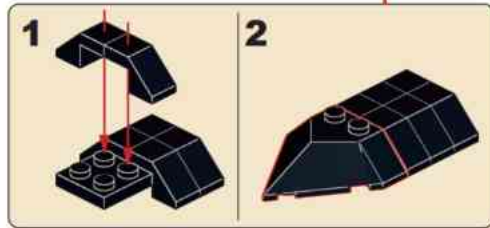

### B115

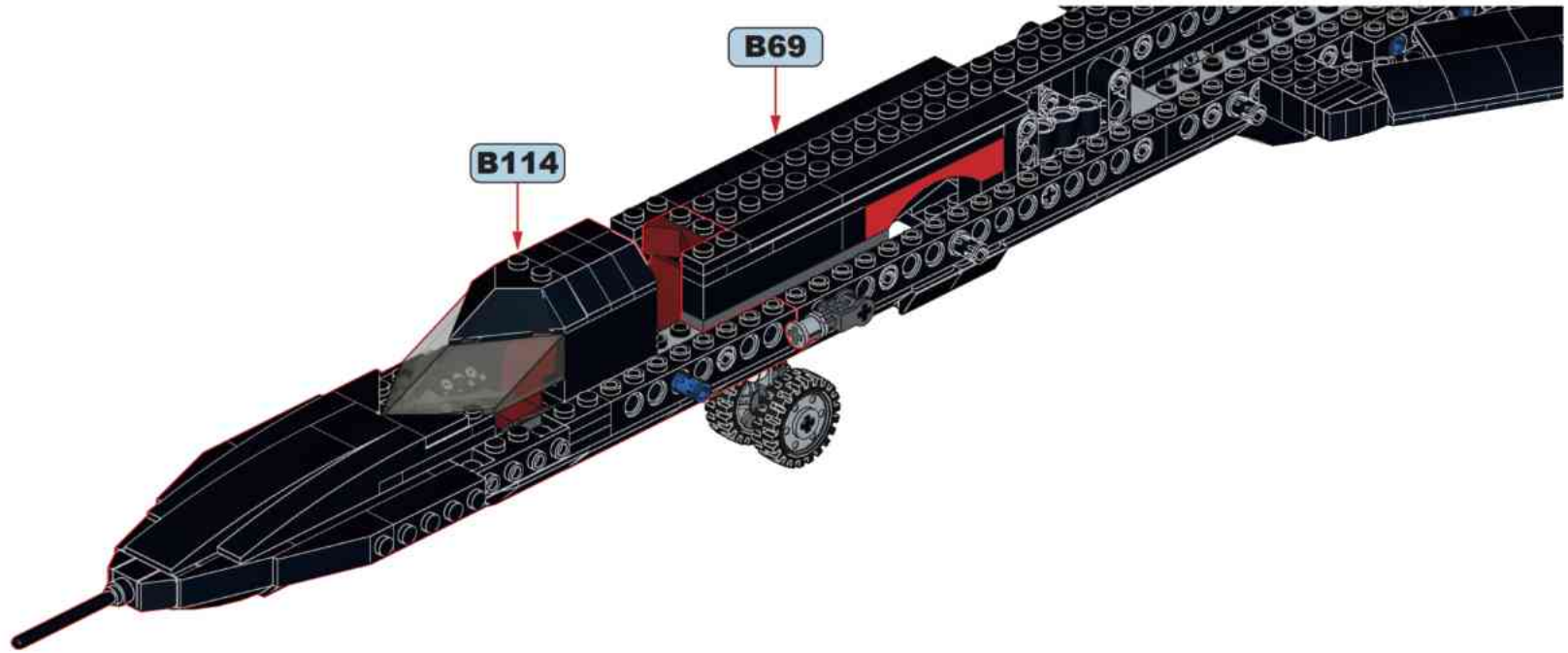

3

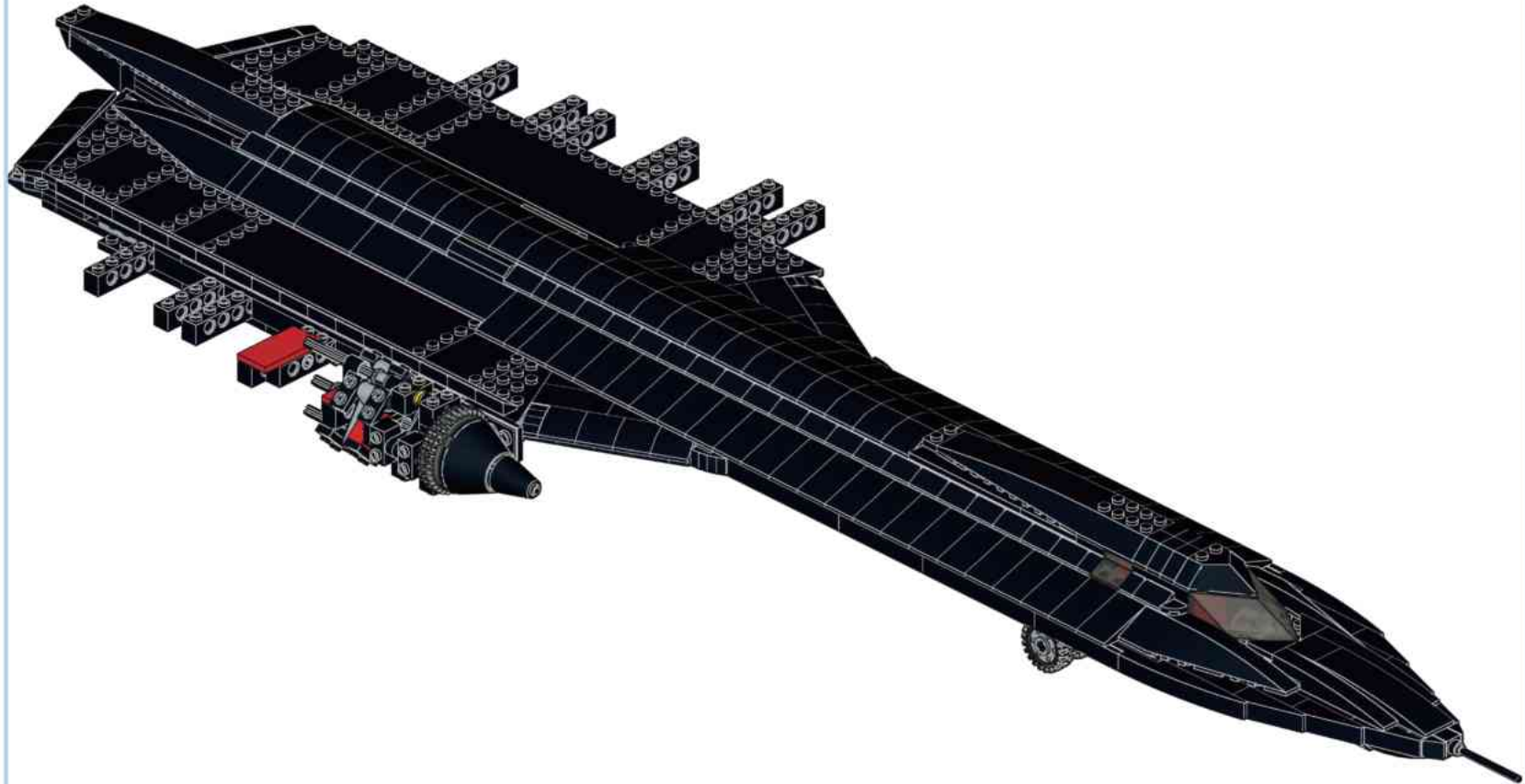

C

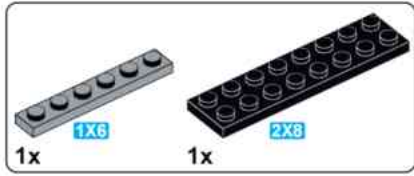

**C1**

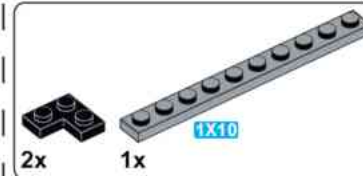

**C2**

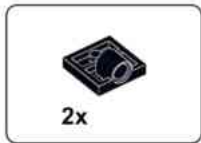
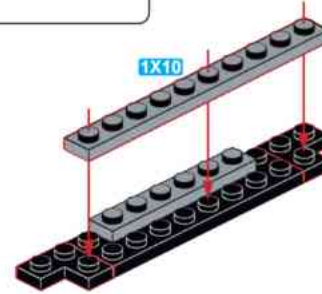

**C3**

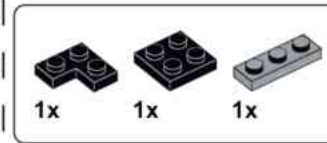

**C4**

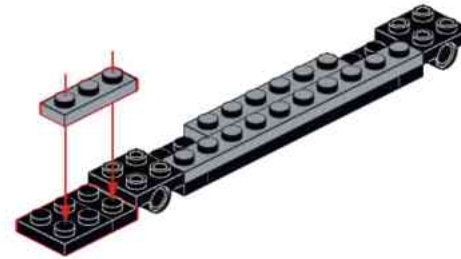

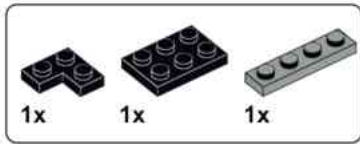

**C5**

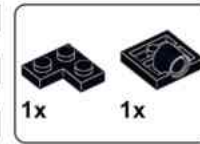
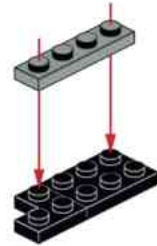

**C6**

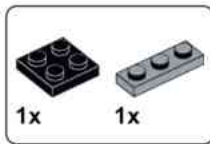
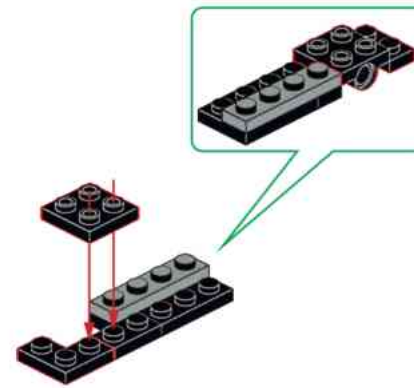

**C7**

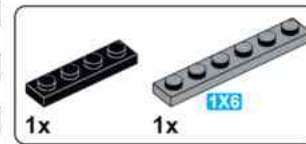
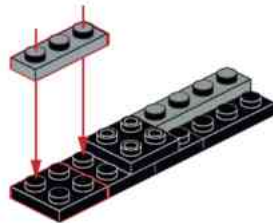

**C8**

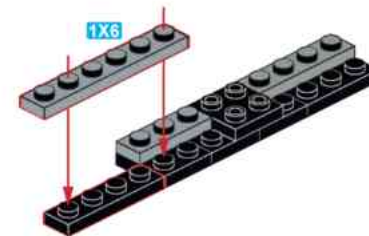

**C9**

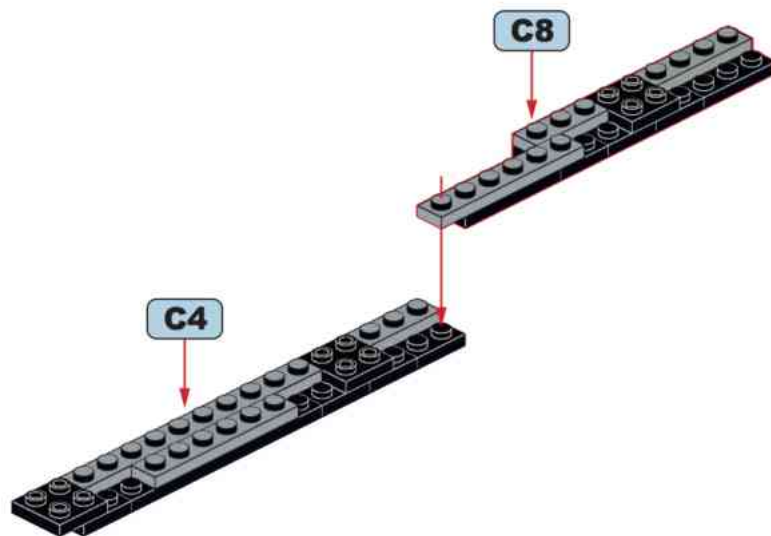

**C10**

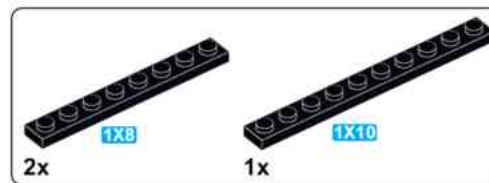
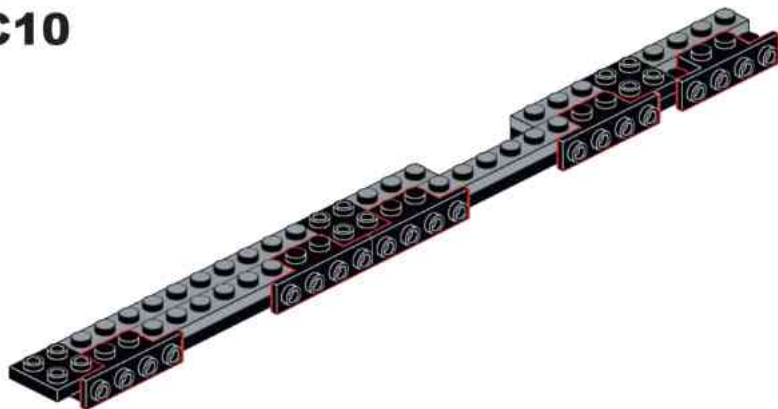

**C11**

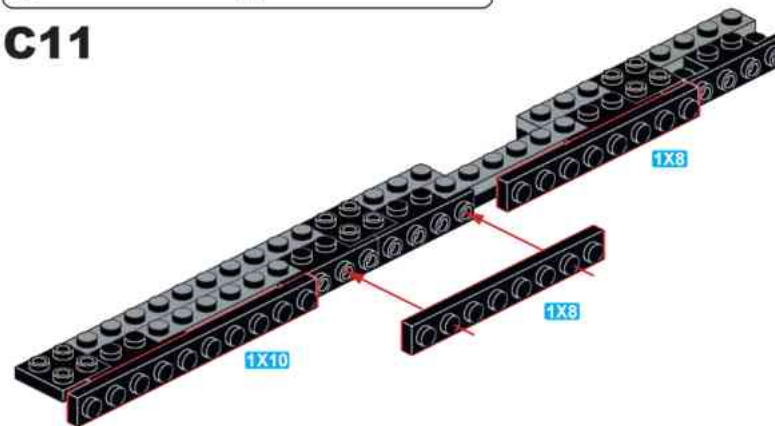

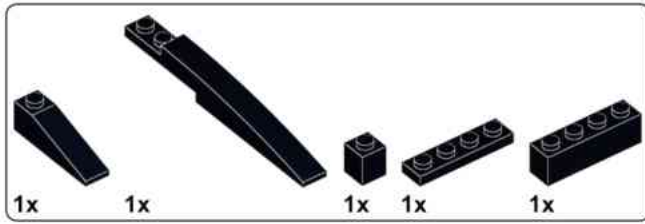

**C12**

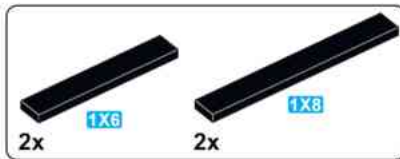
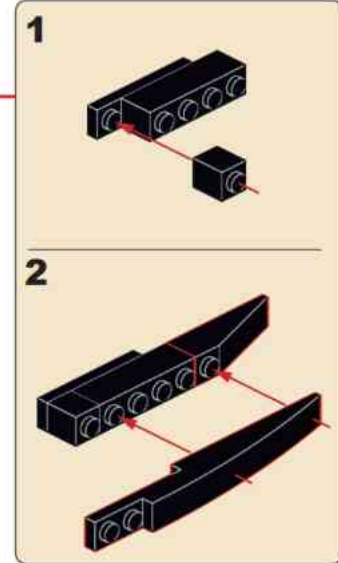
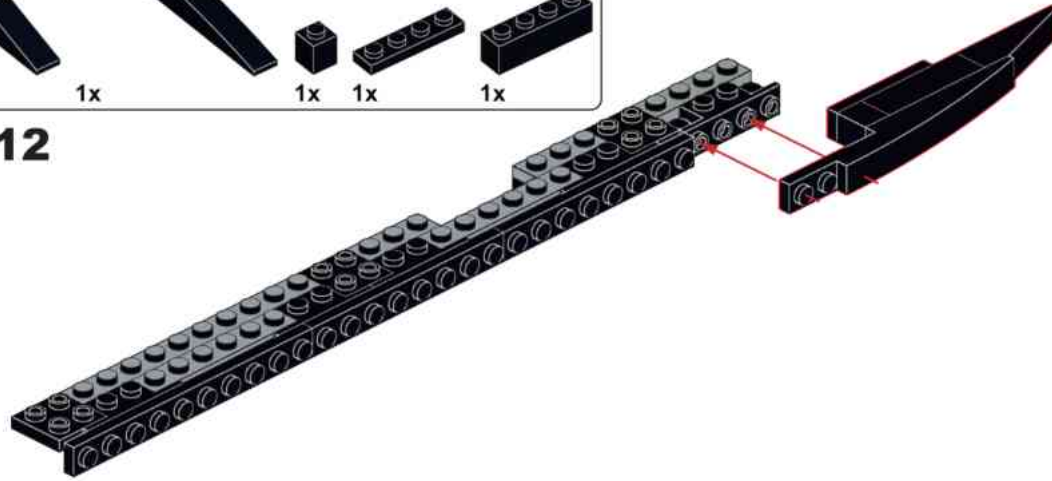

**C13**

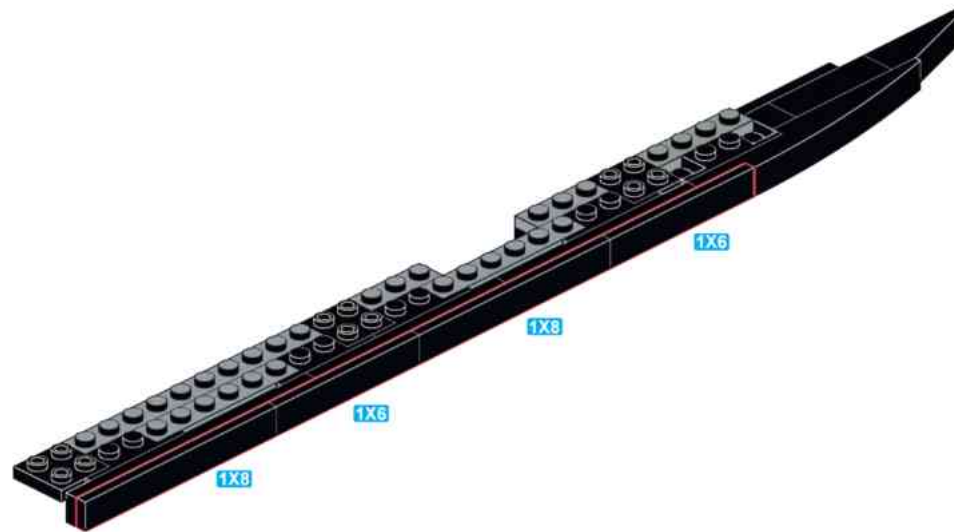

**C14**

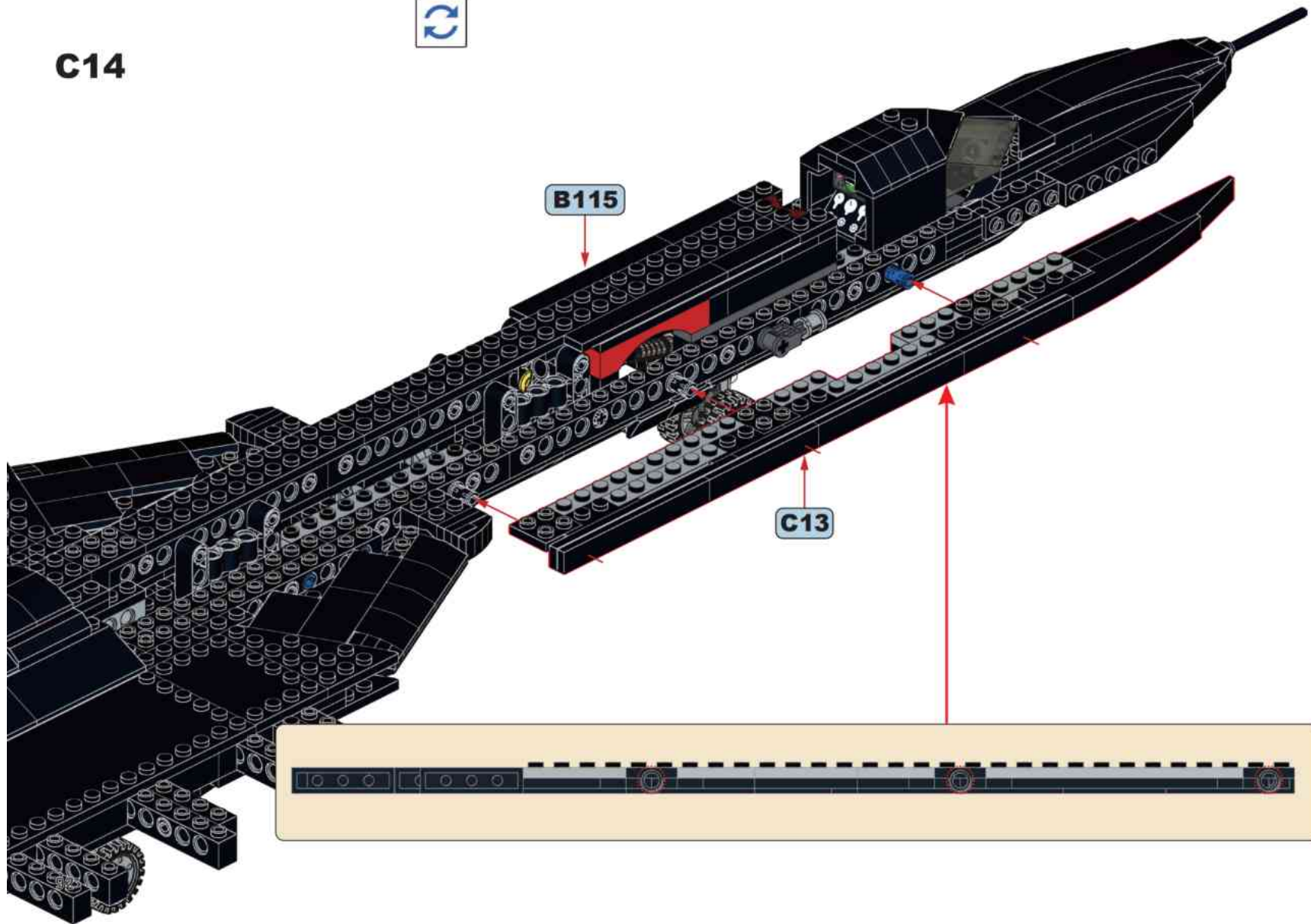

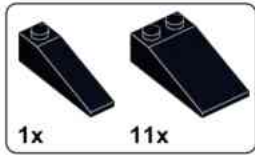

**C15**

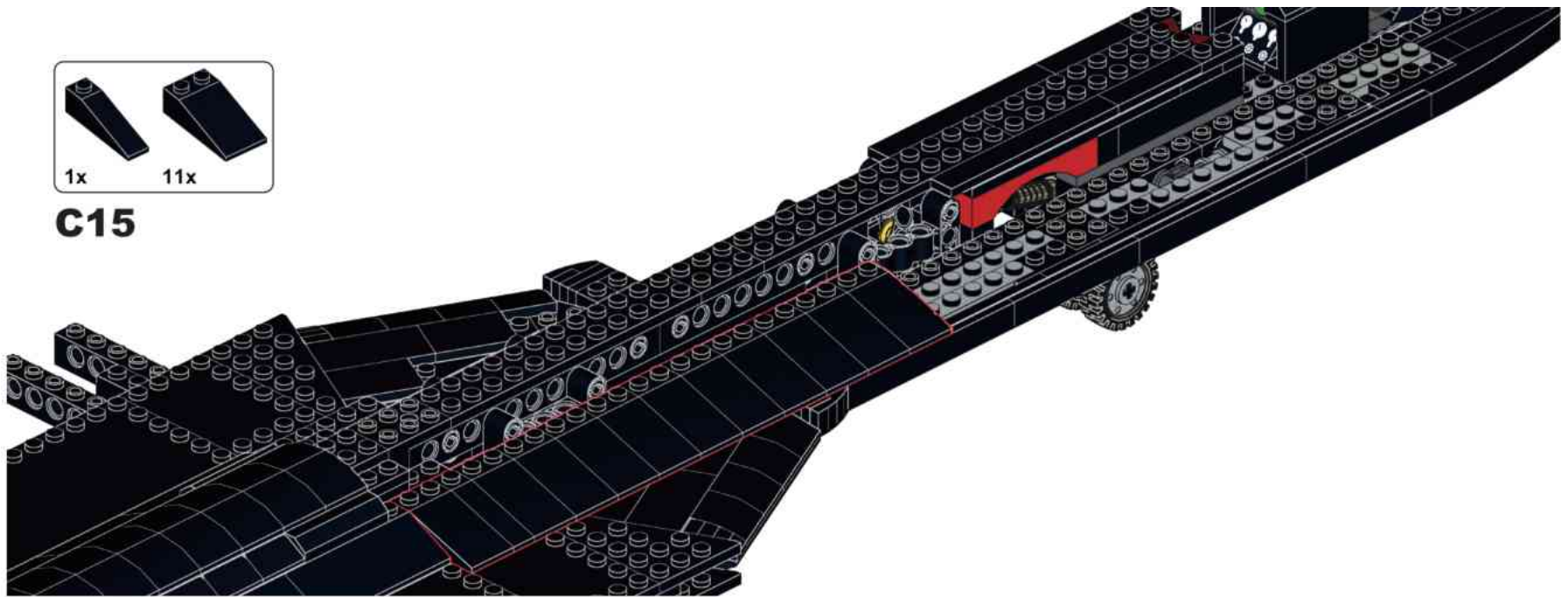

**C16**

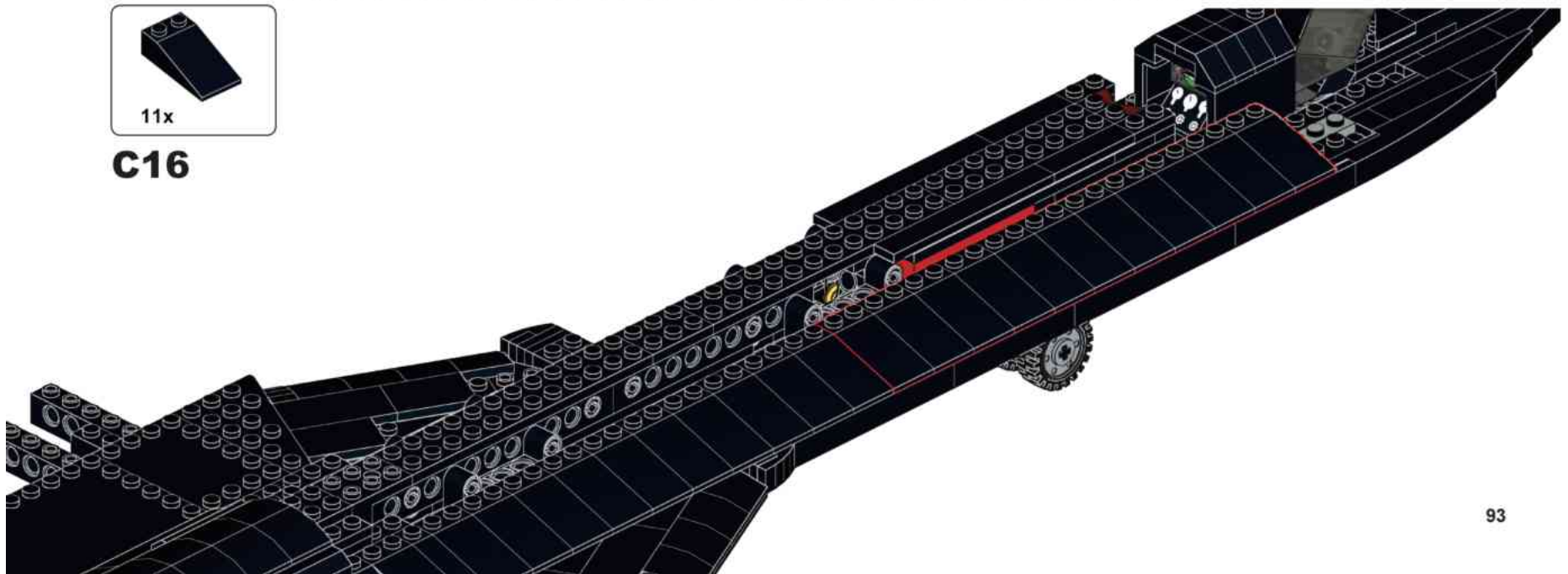

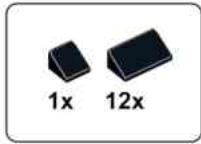

**C17**

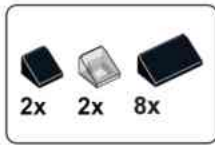
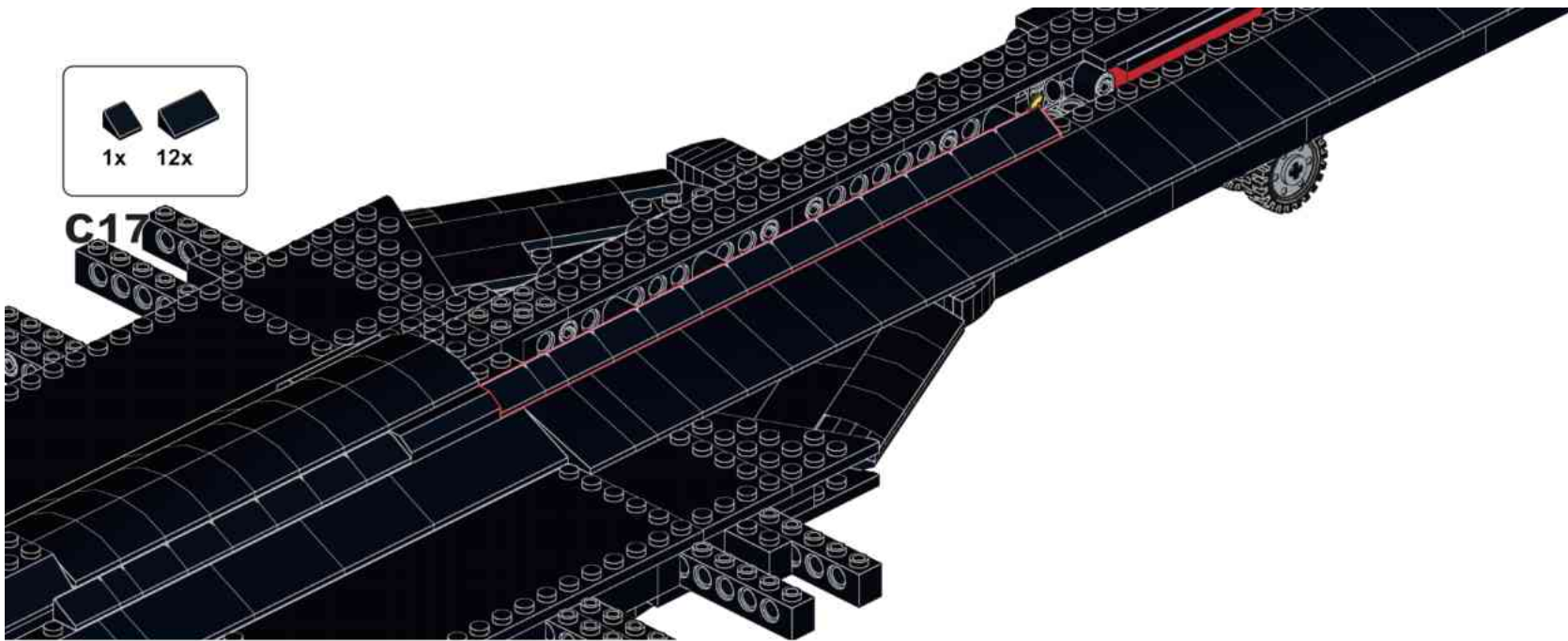

**C18**

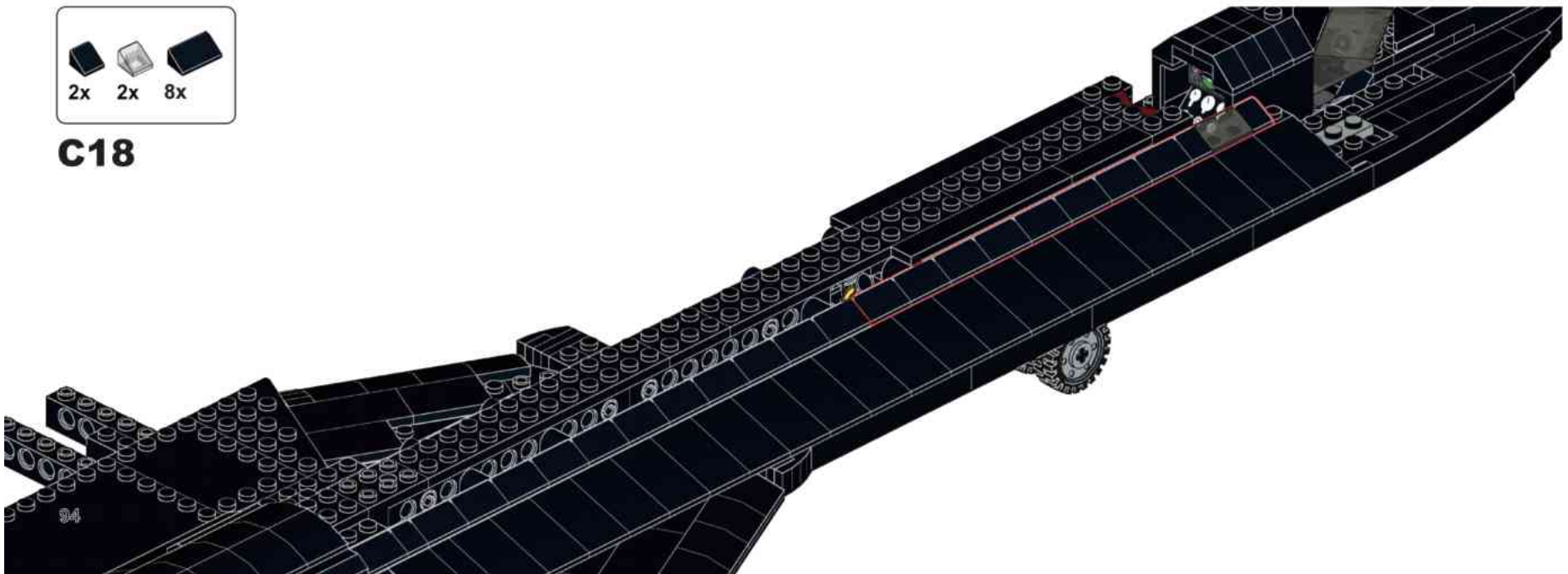

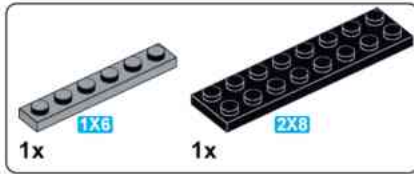

**C19**

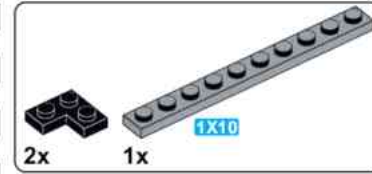

**C20**

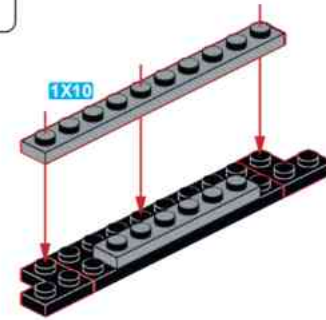

**C21**

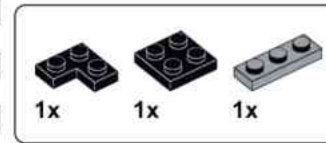

**C22**

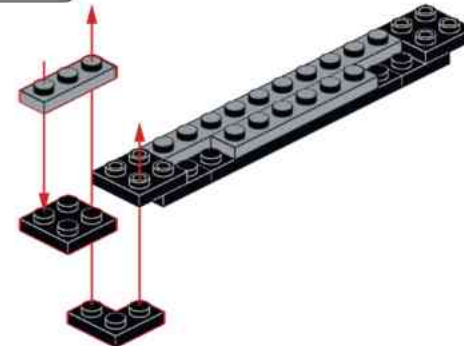

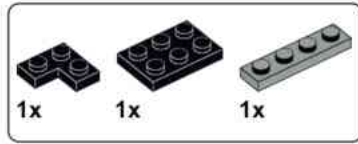

**C23**

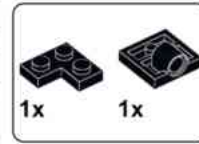

**C24**

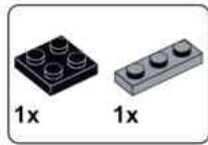
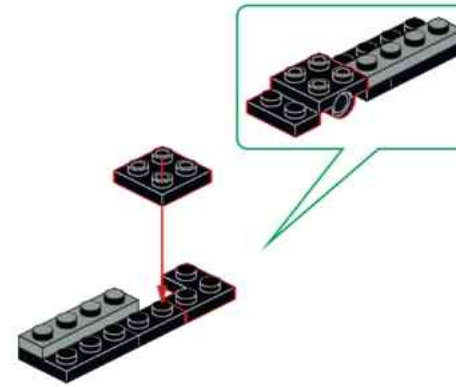

**C25**

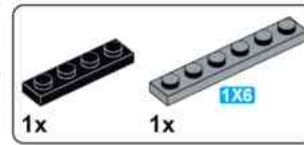
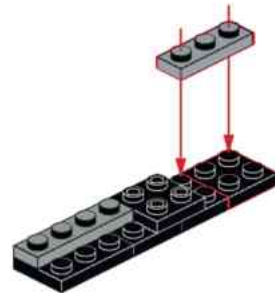

**C26**



## C27

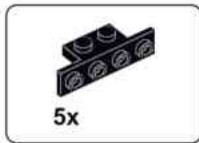
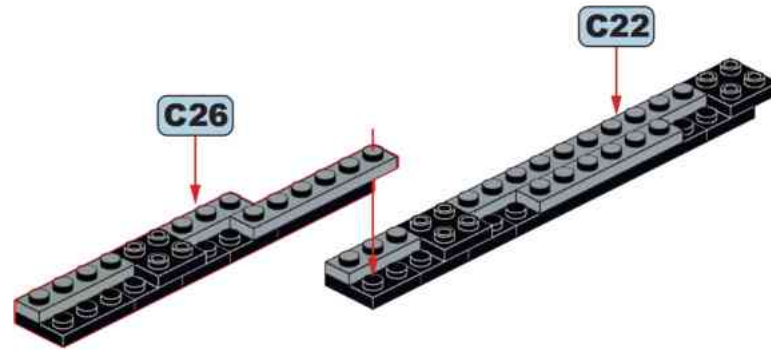

## C28

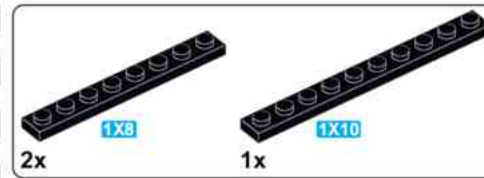
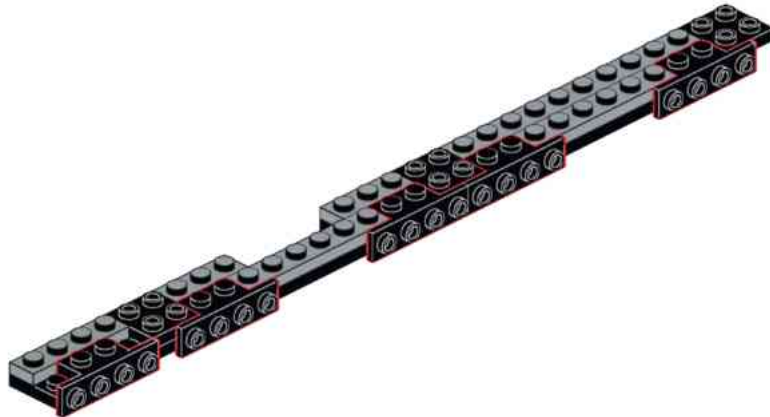

## C29

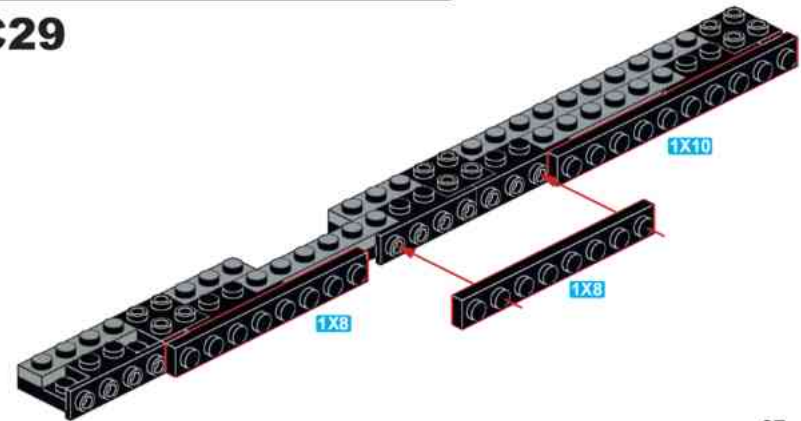



C32

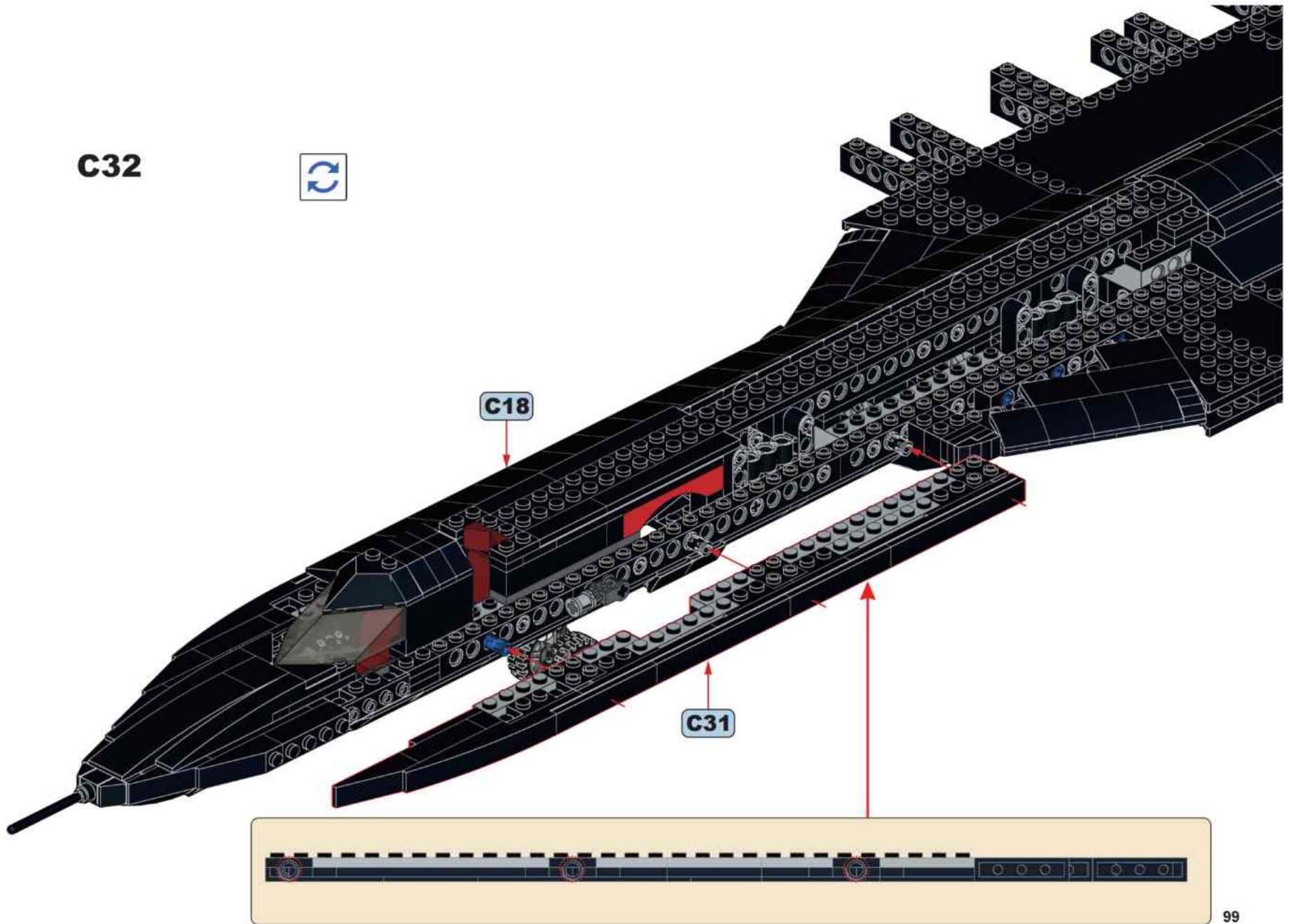

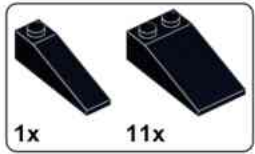

**C33**



**C34**



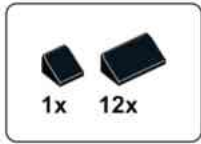

**C35**

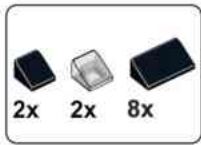
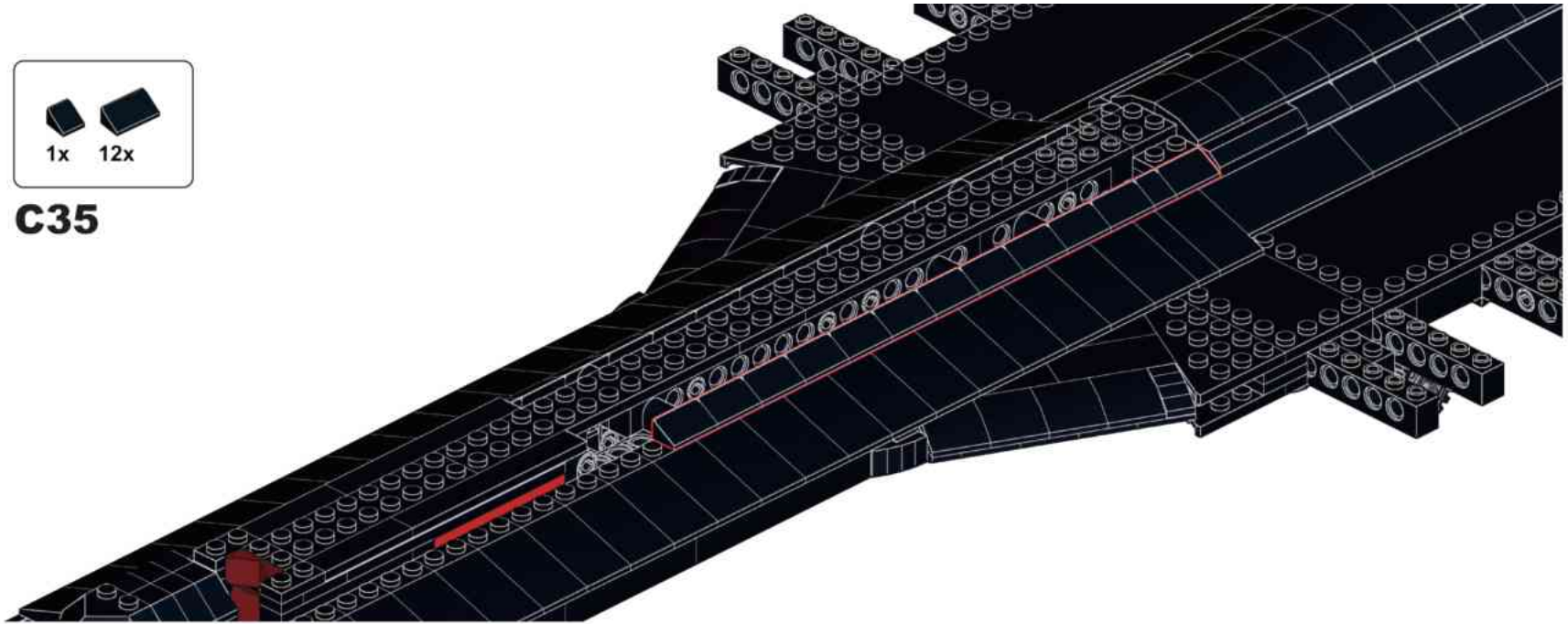

**C36**

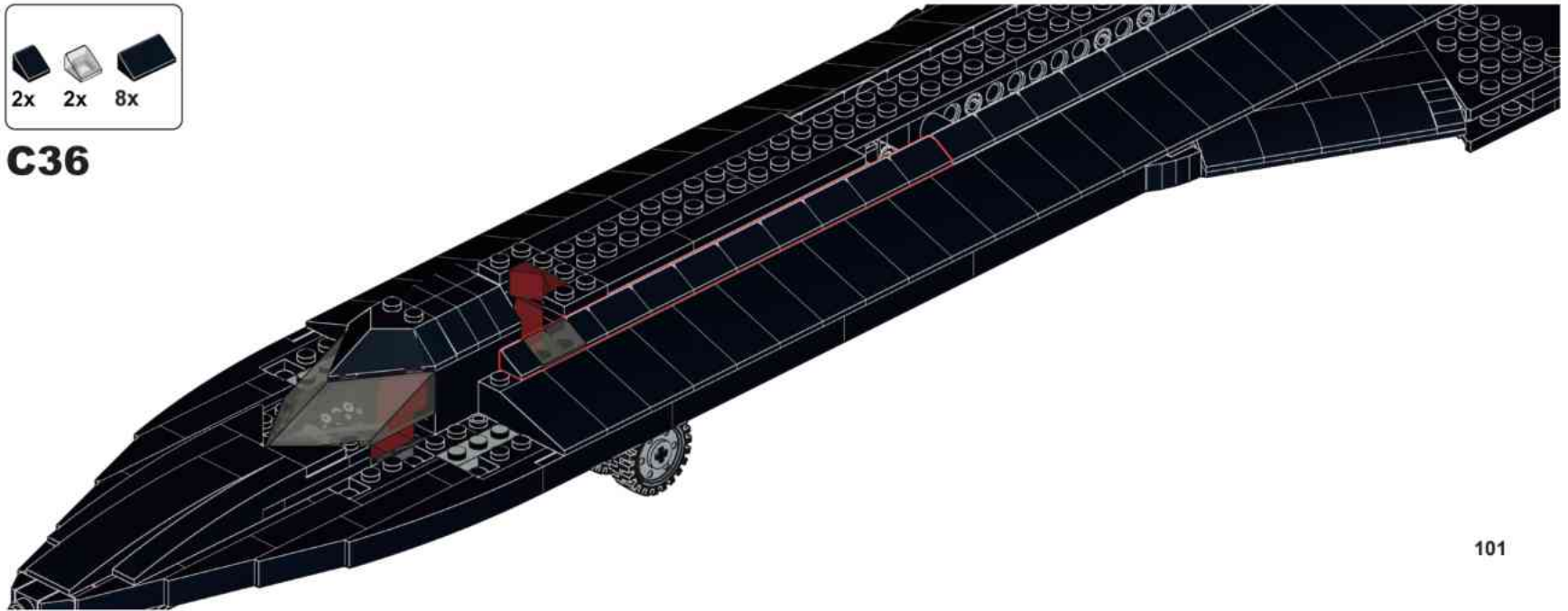

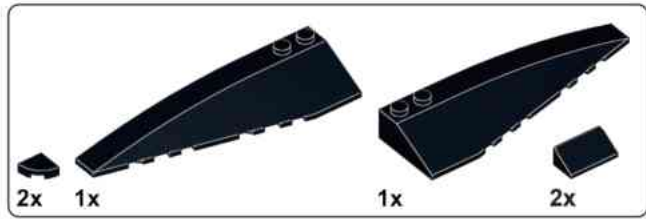

**C37**

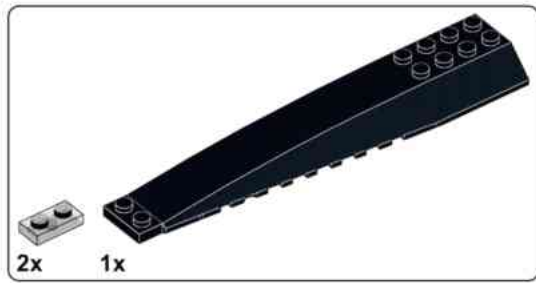
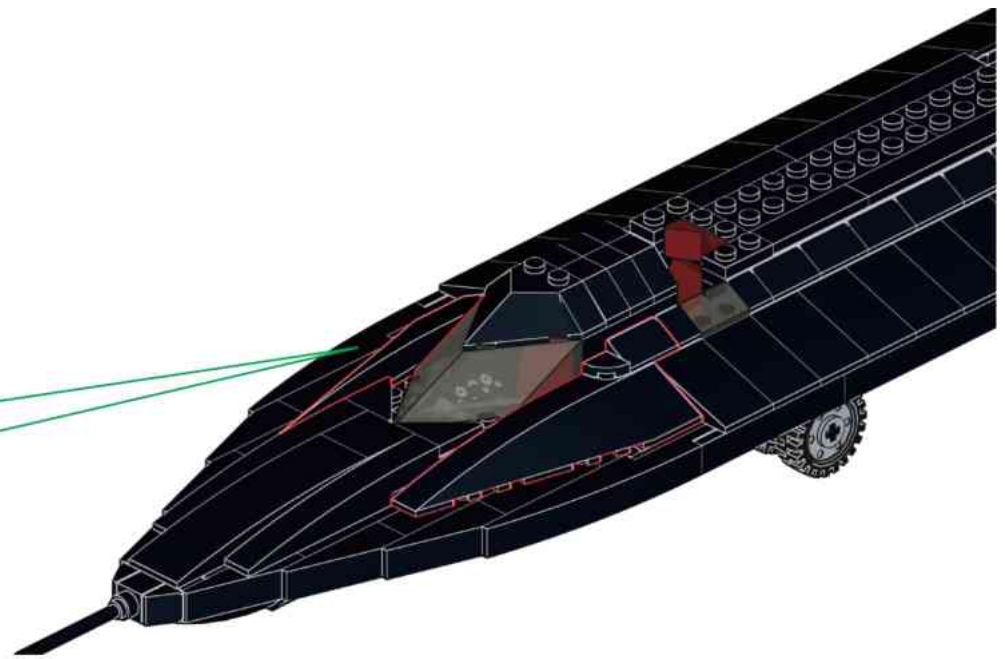
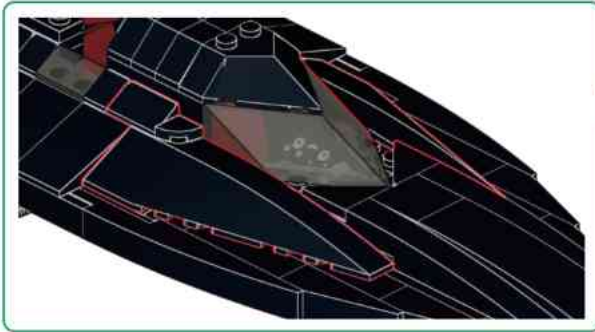

**C38**

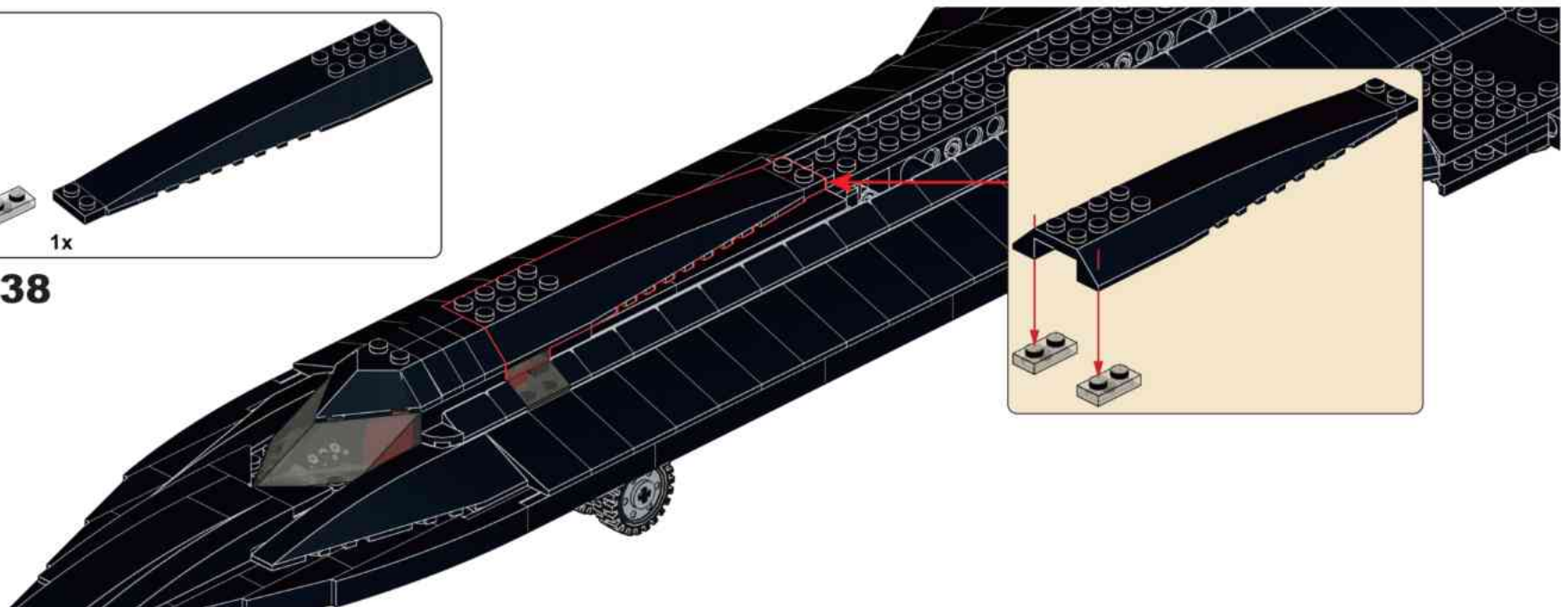
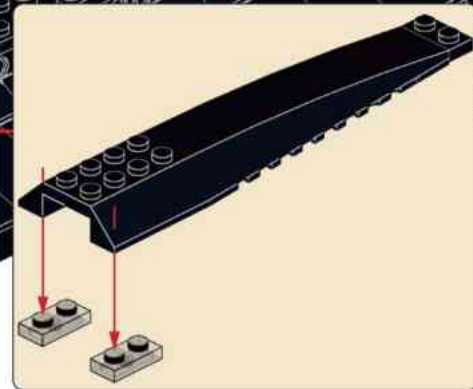



**C39**

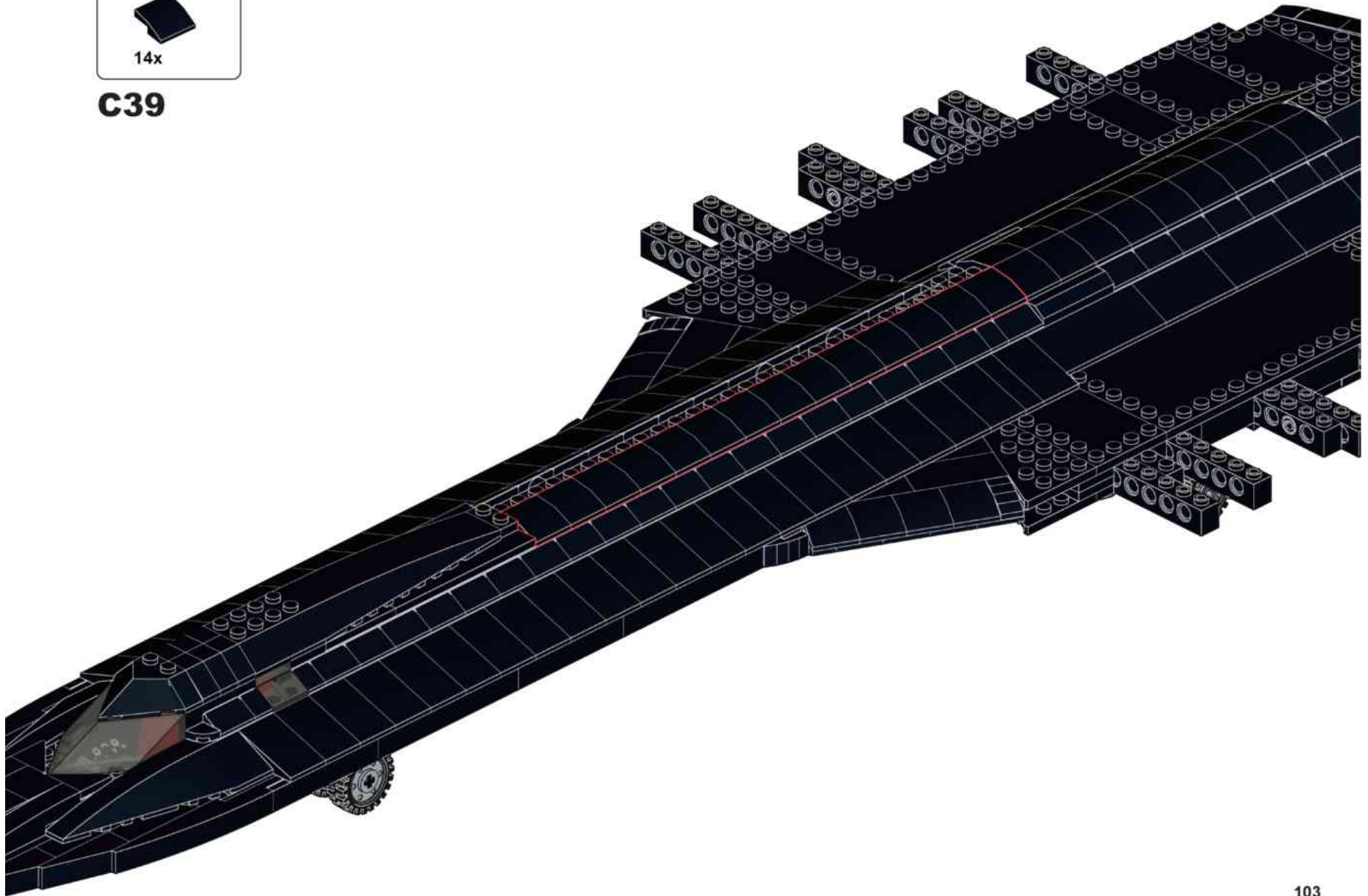



**C40**

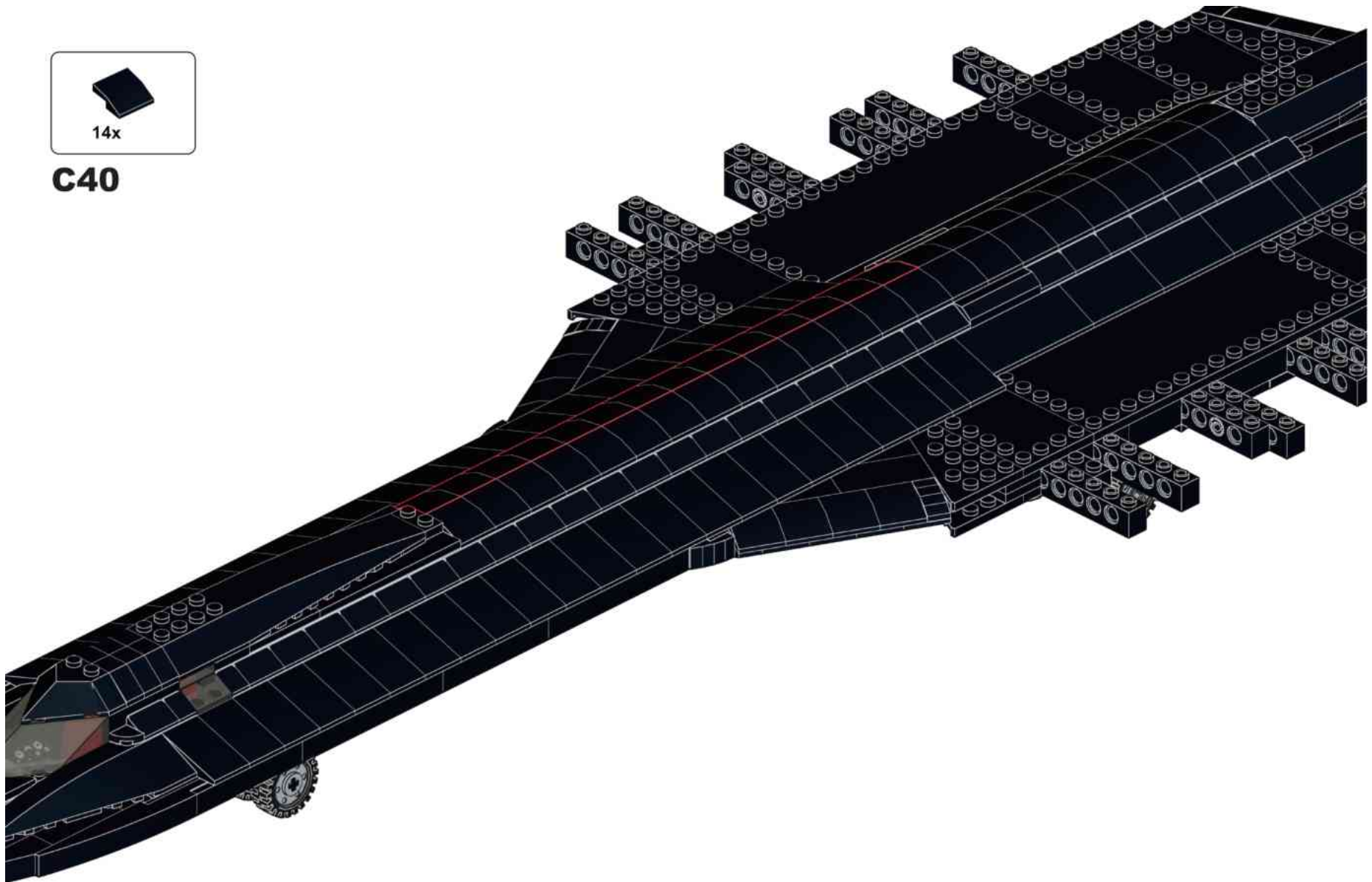

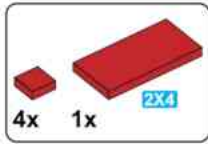

**C41**

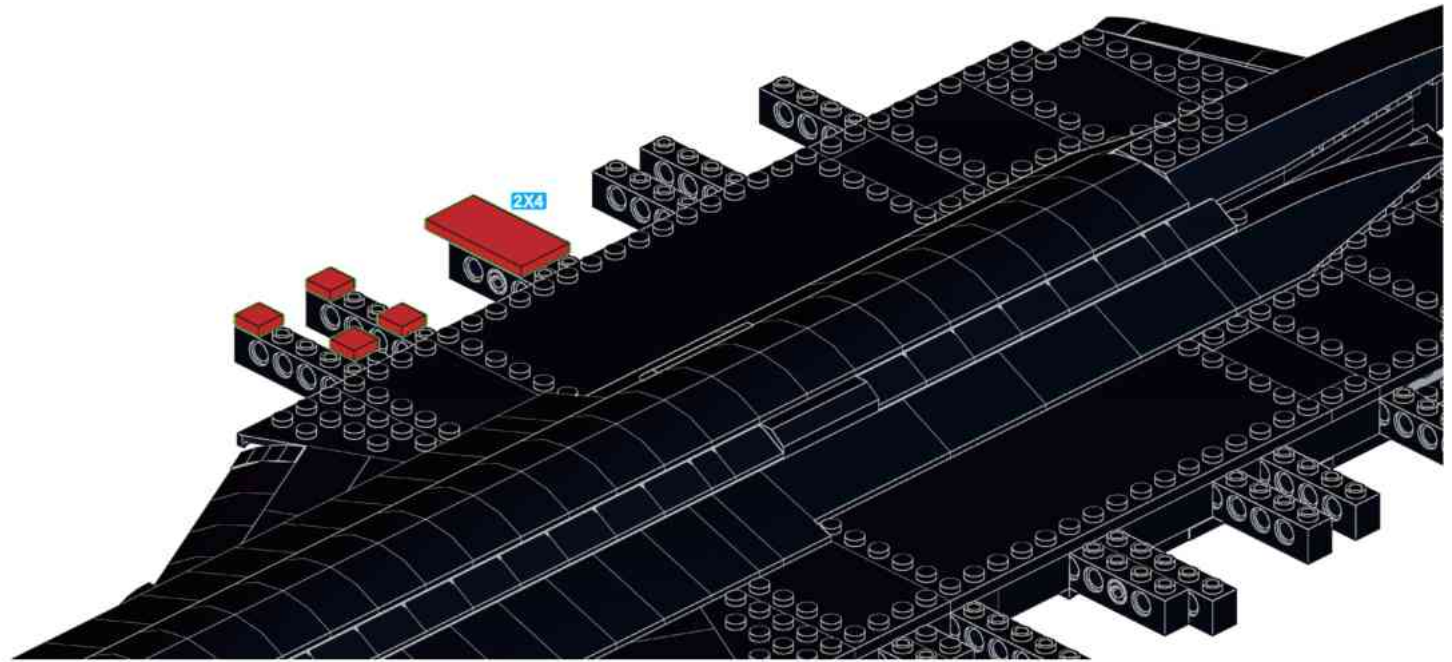

**C42**

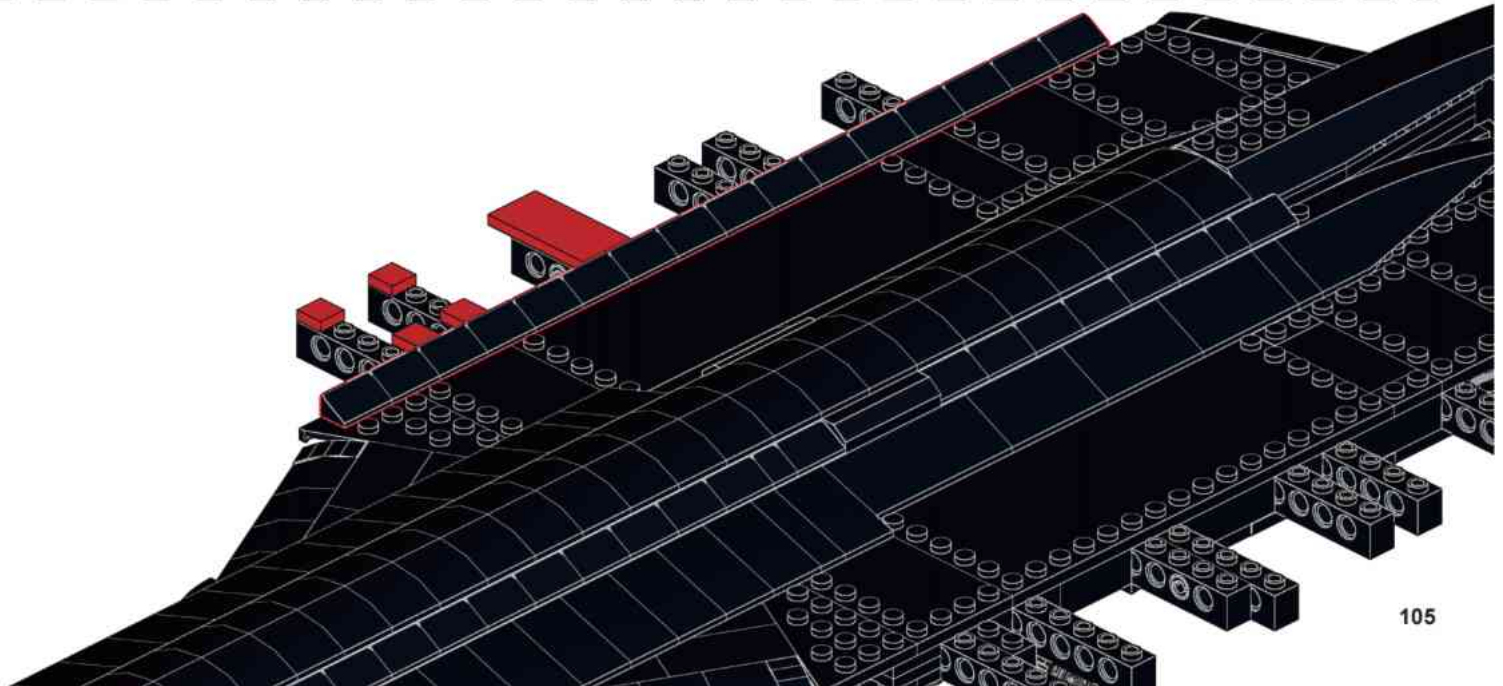

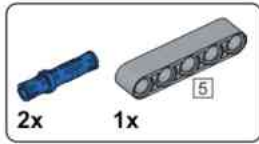

**C43**

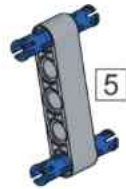

**C44**

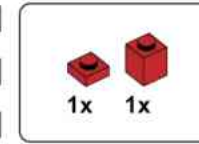

**C45**

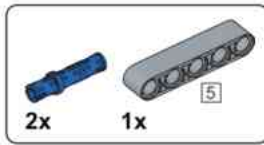

**C46**

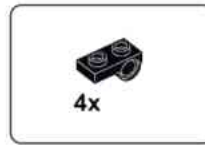

**C47**



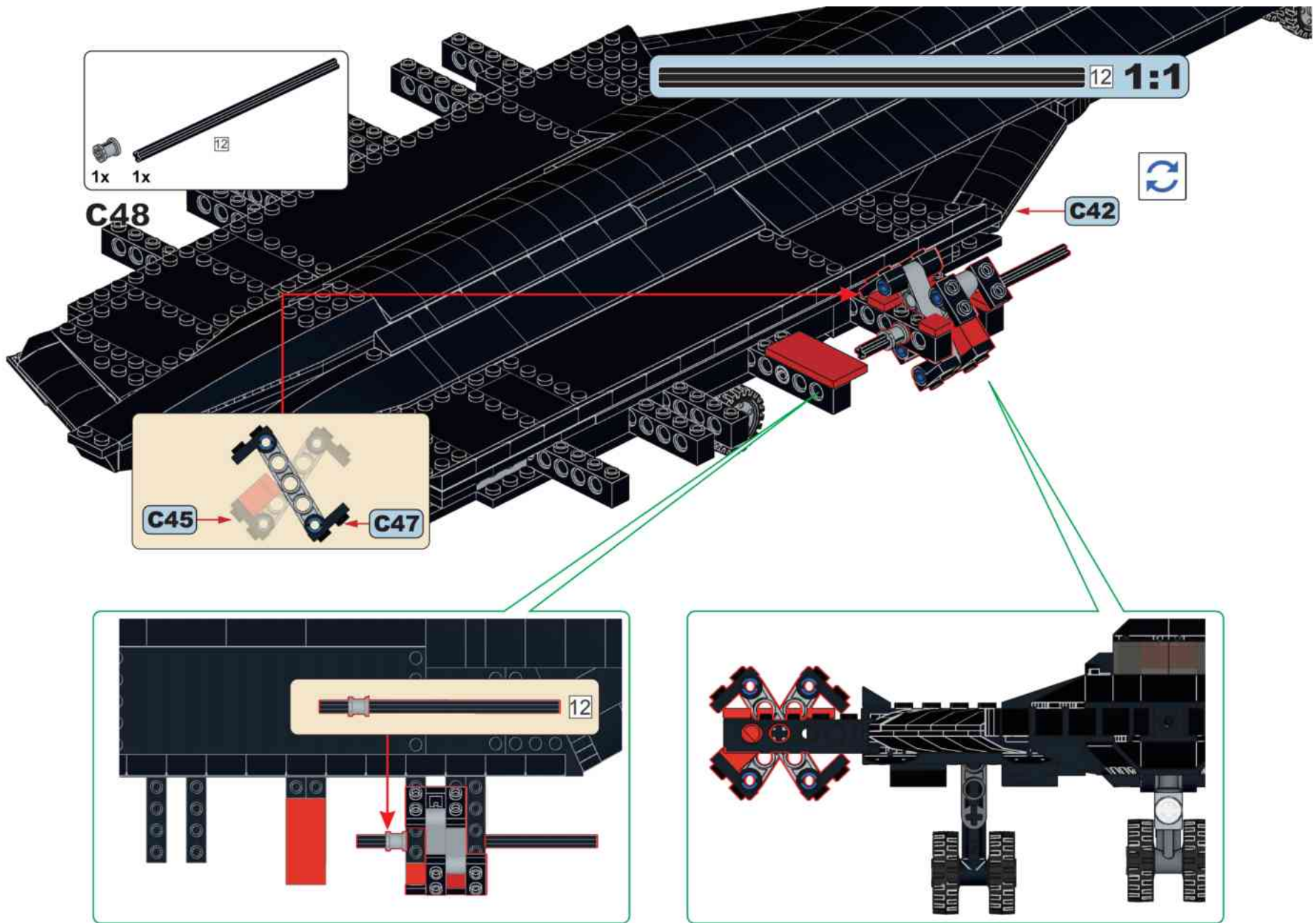

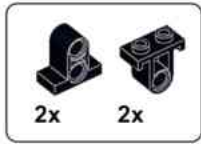

**C49**

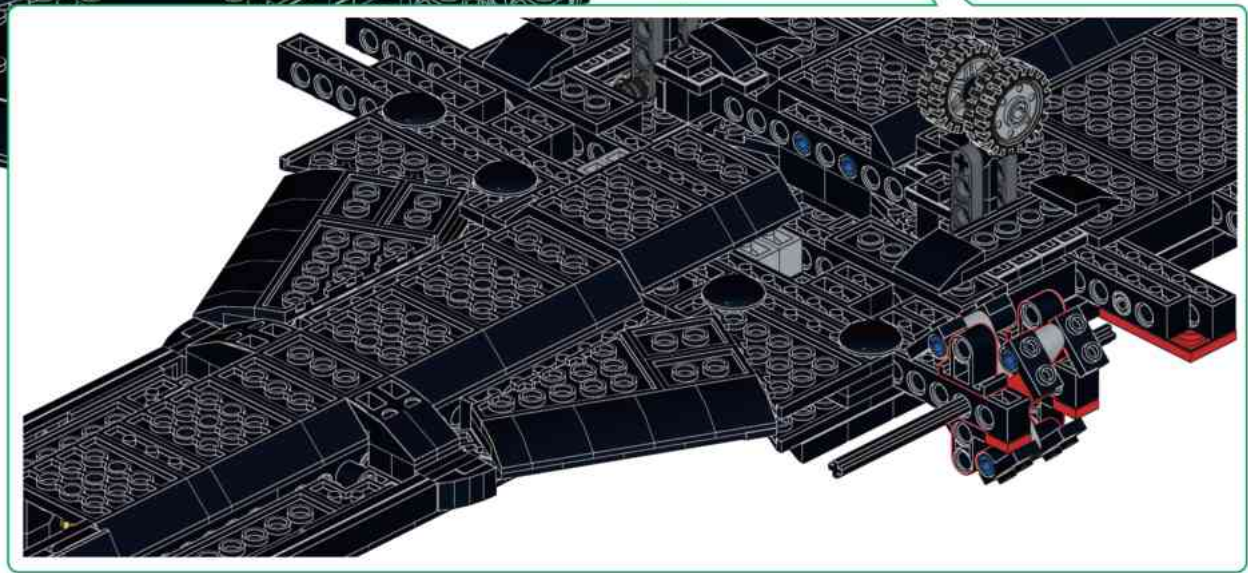
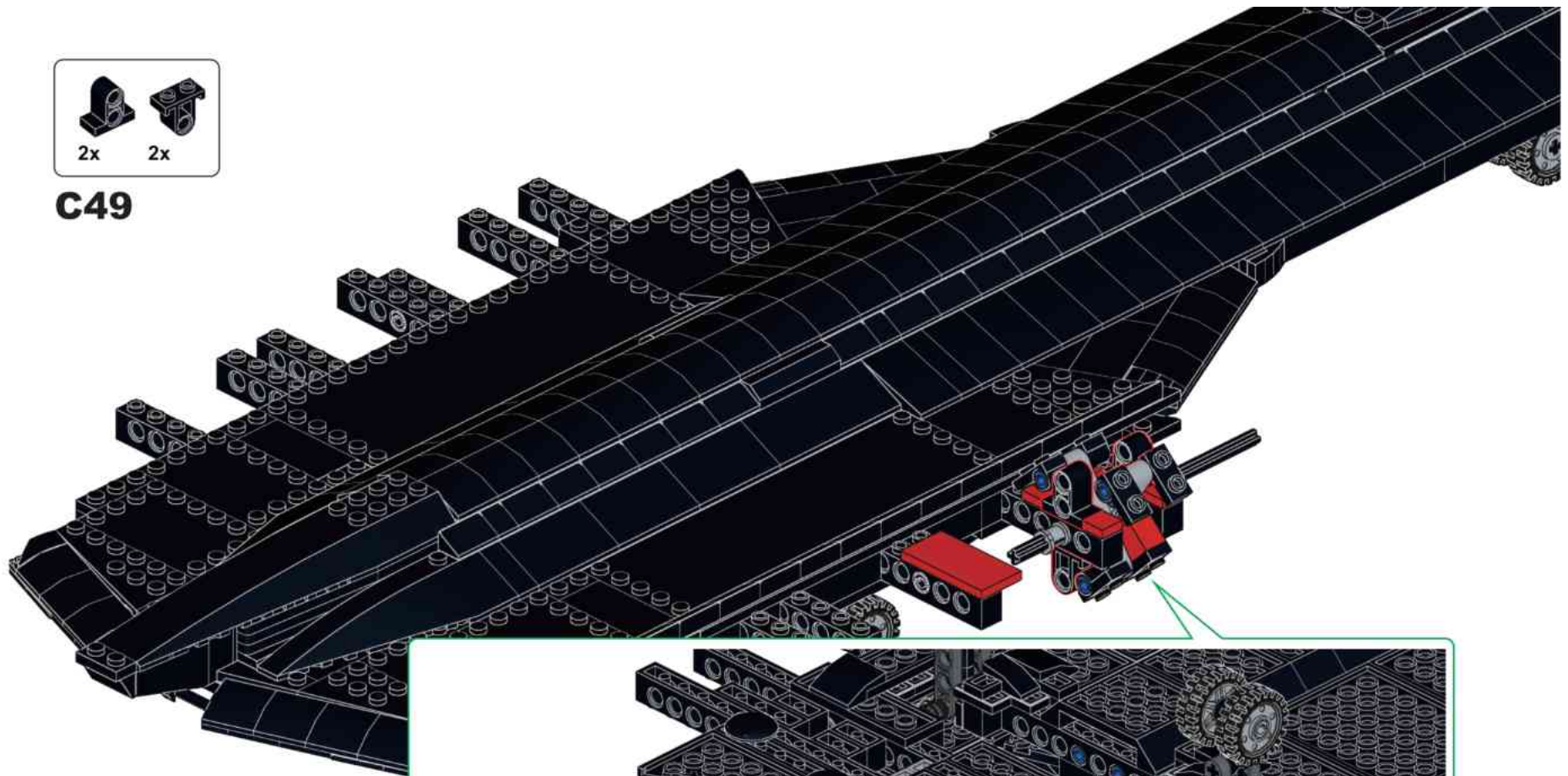

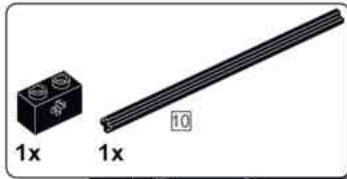

C50

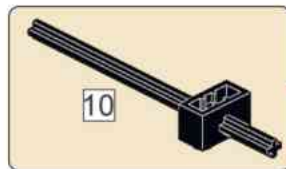
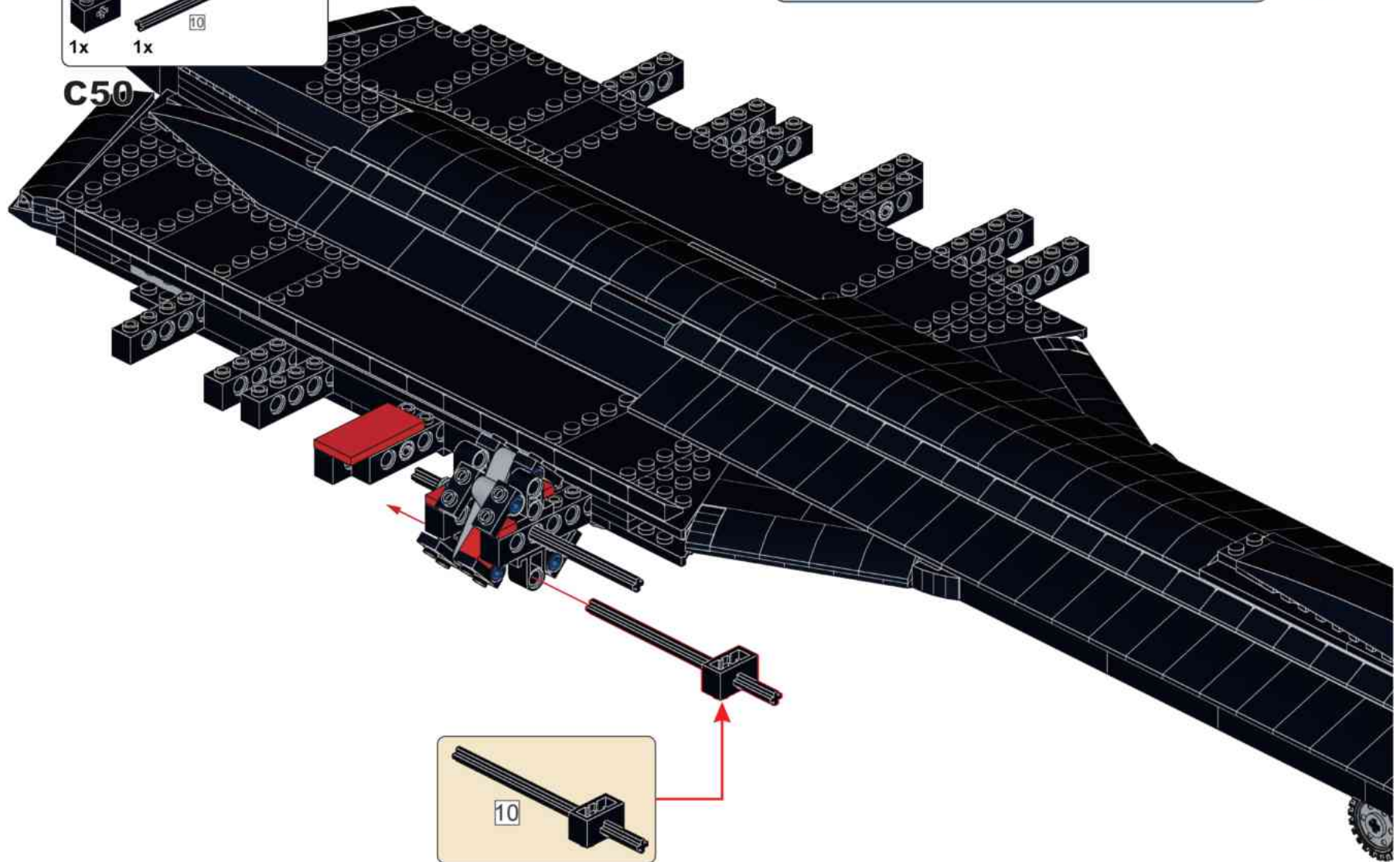

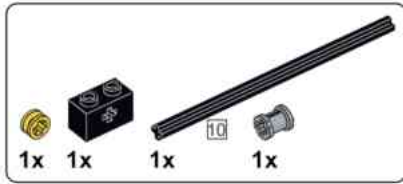

**C51**

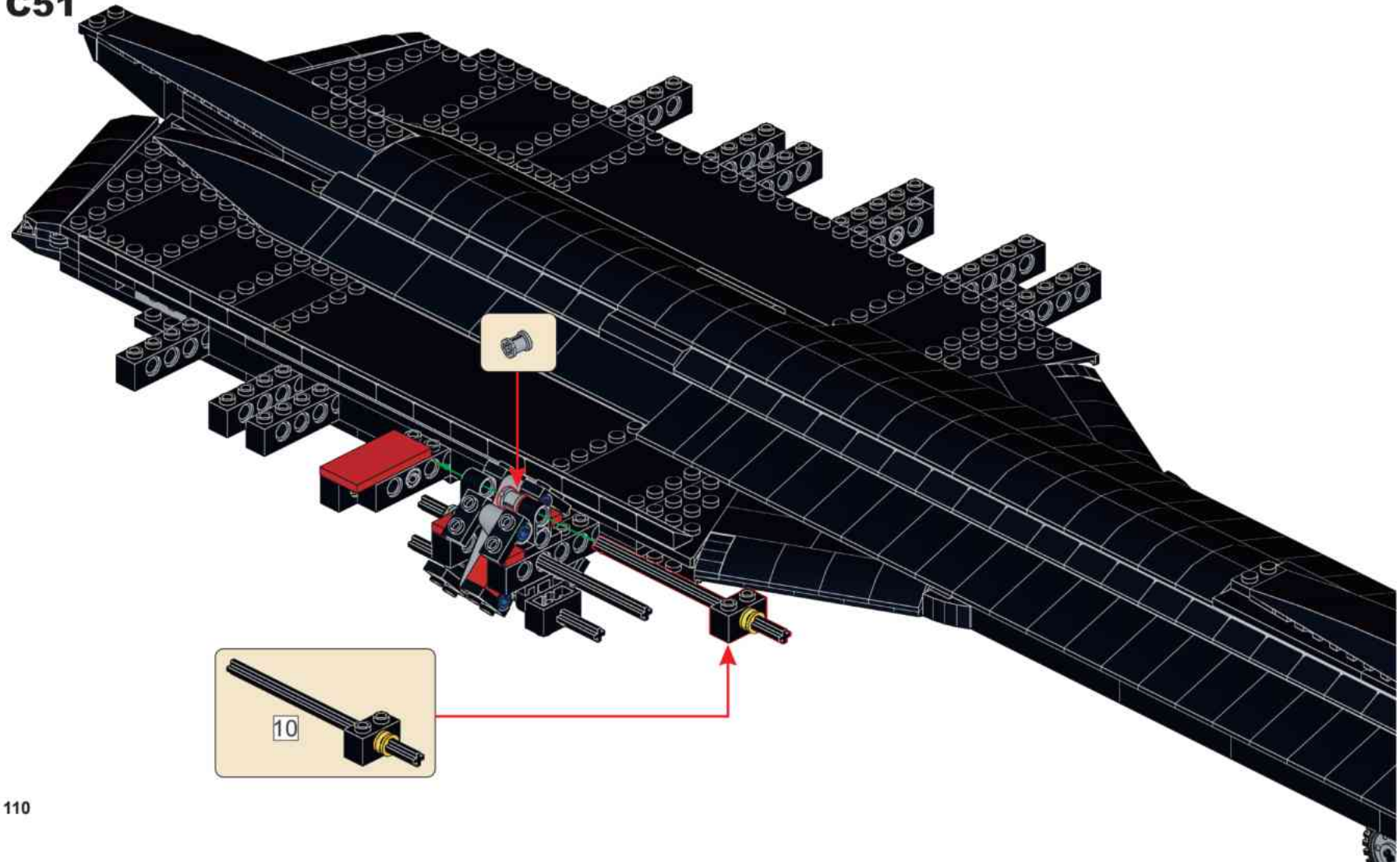

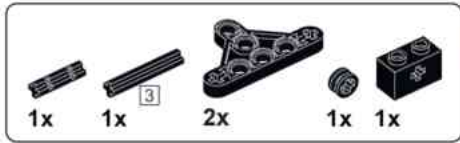

3 1:1

C52

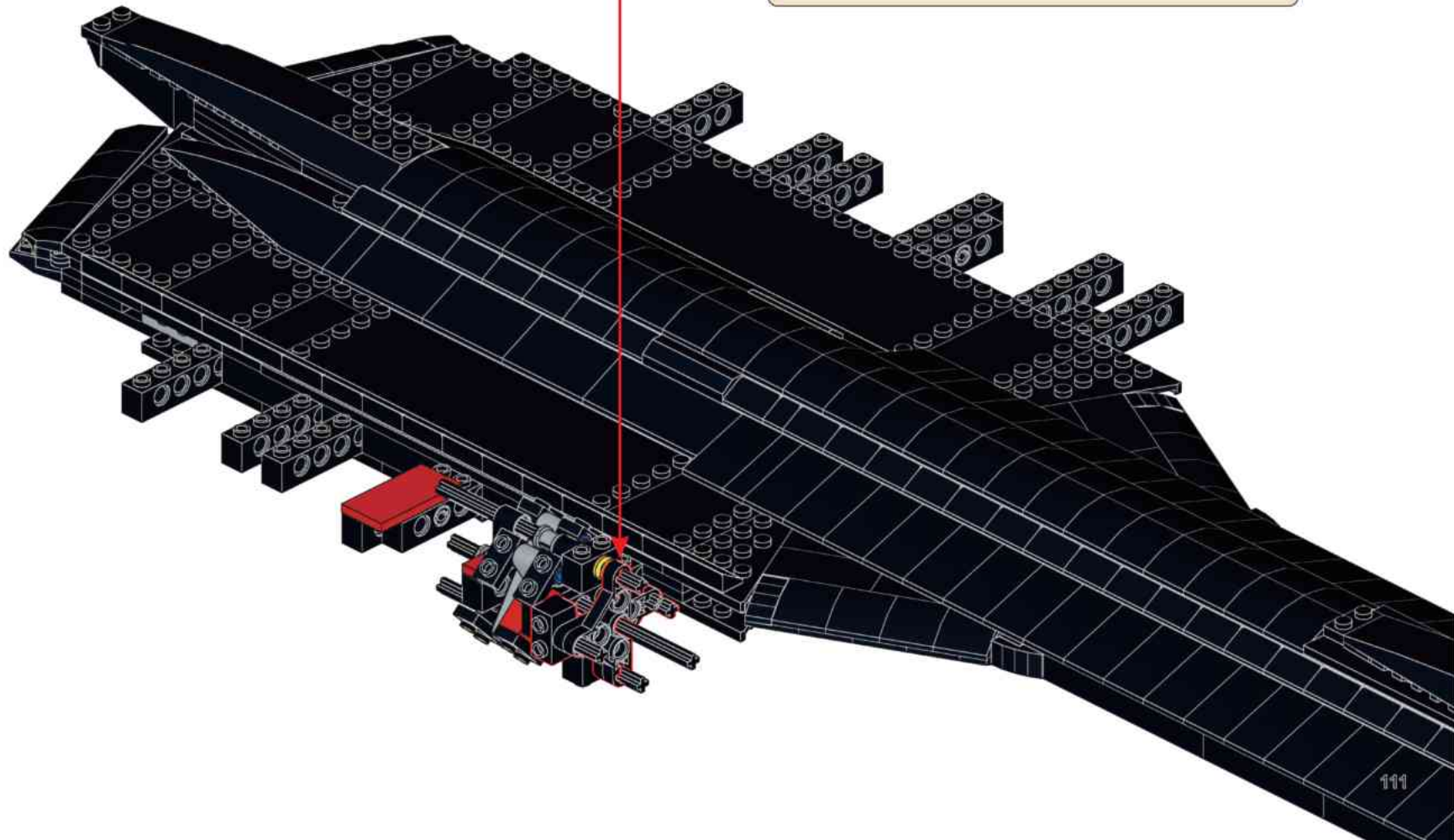
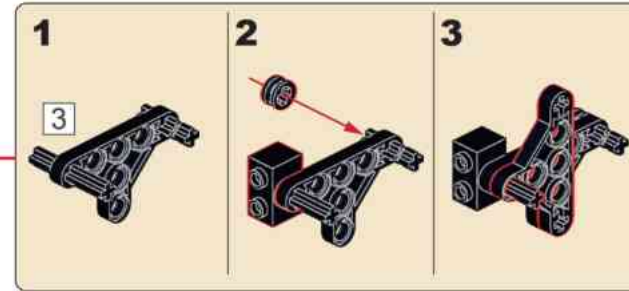

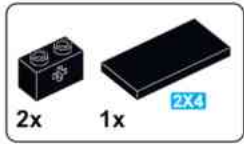

**C53**

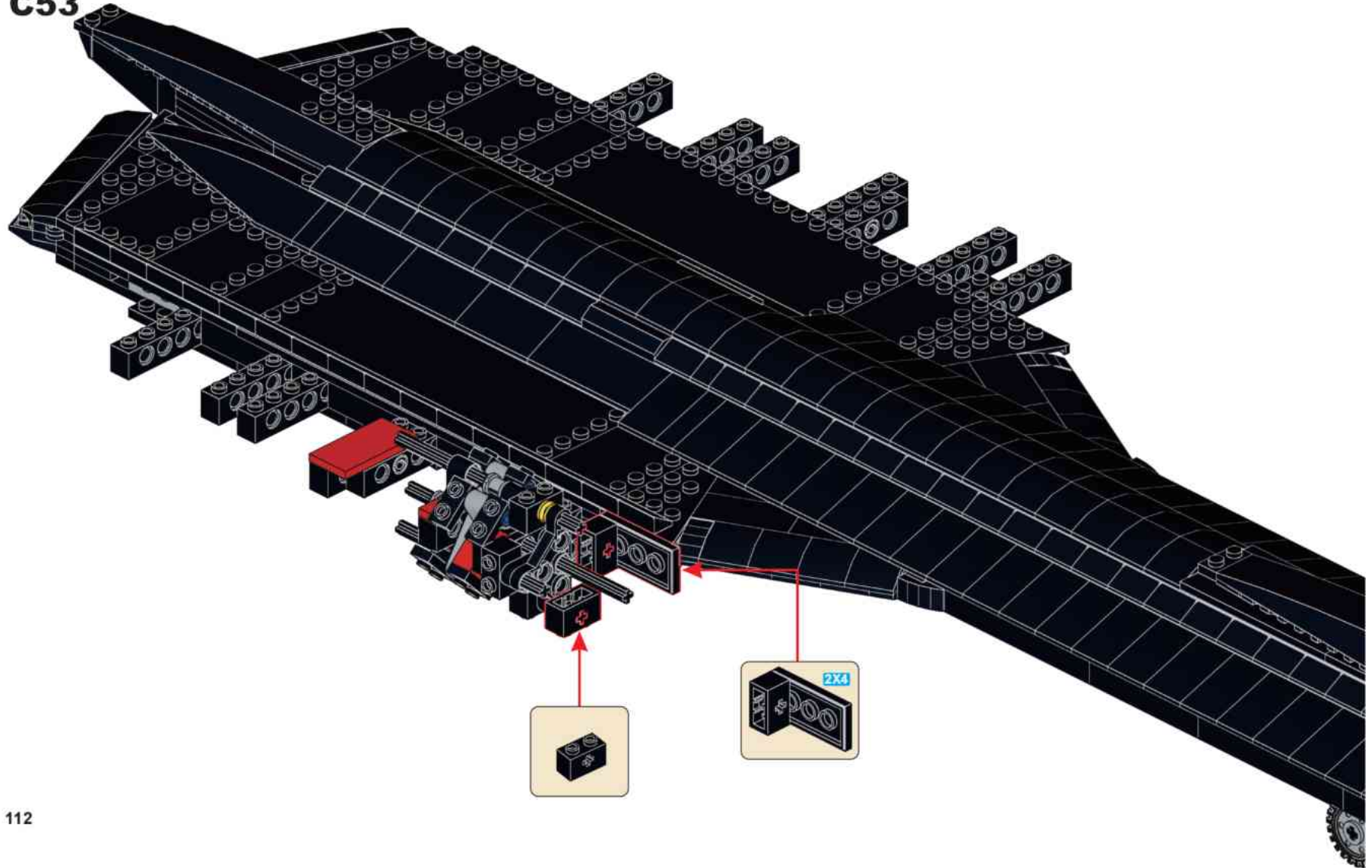

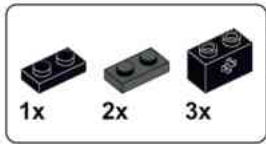

**C54**

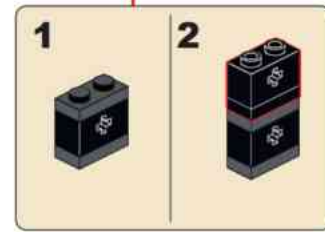
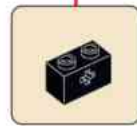
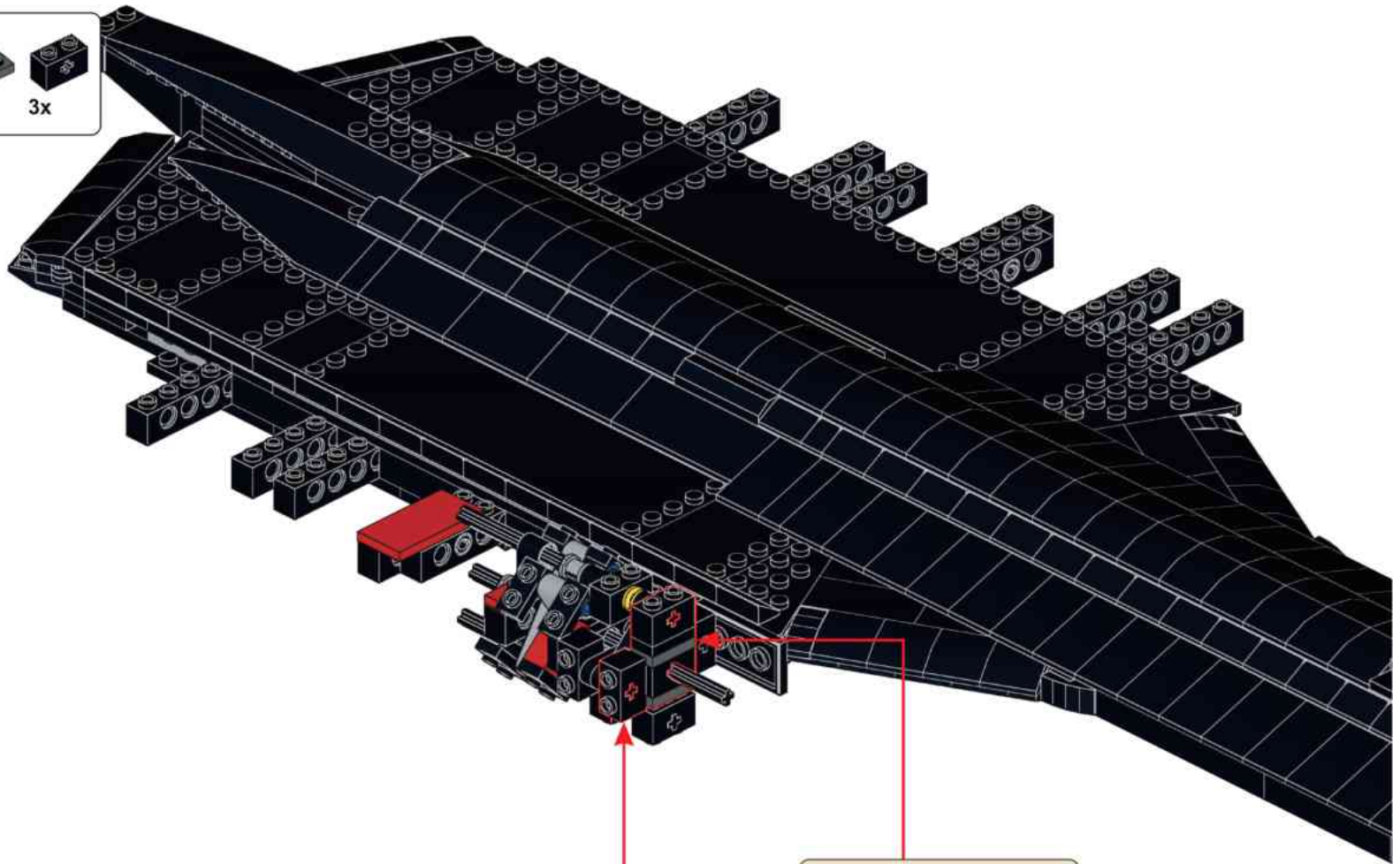

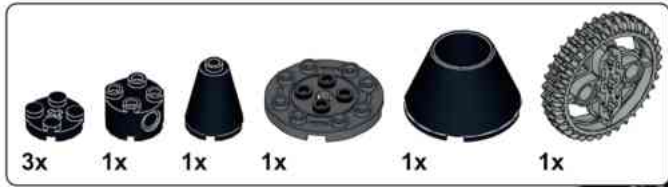

### C55

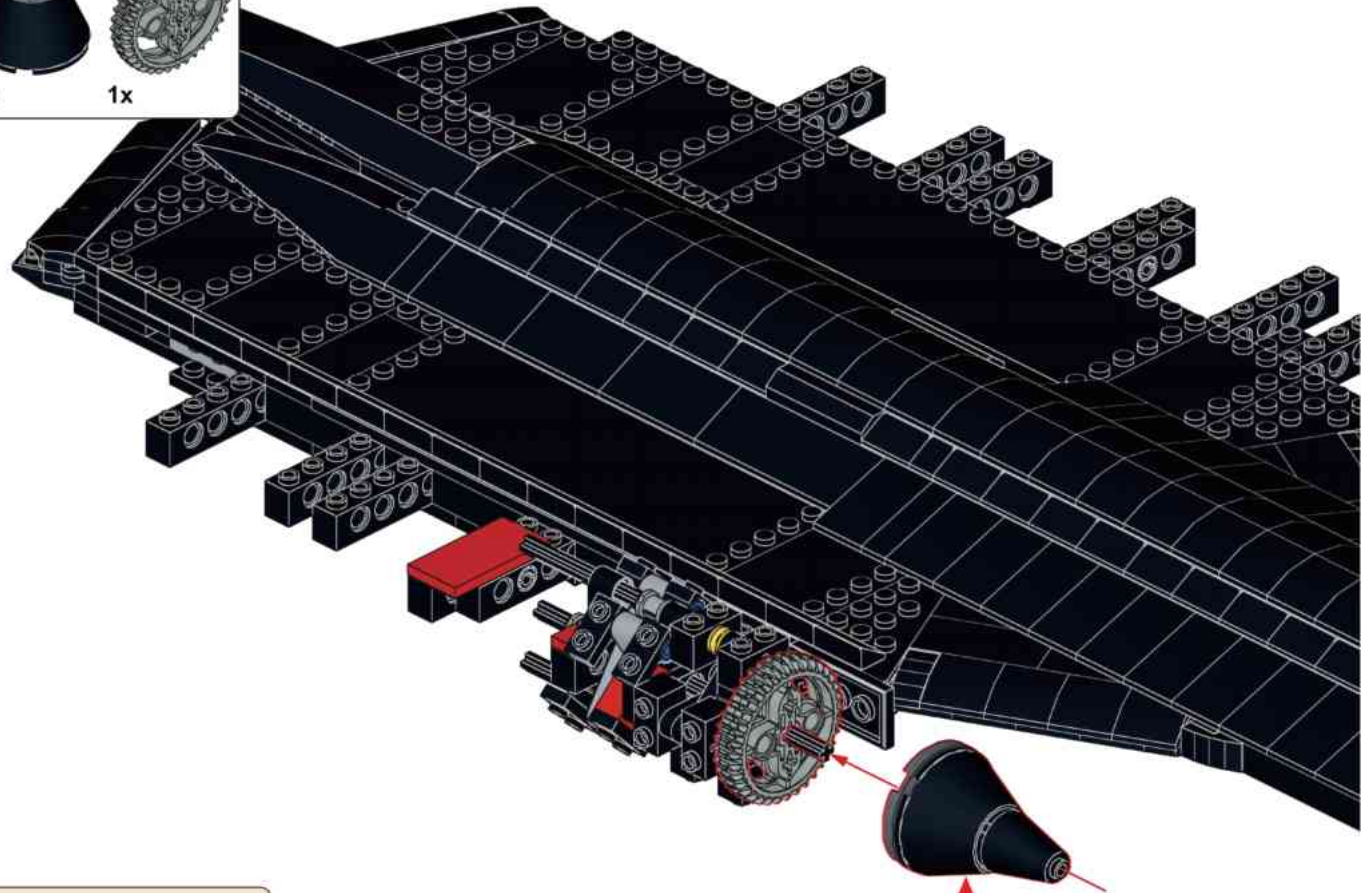

4

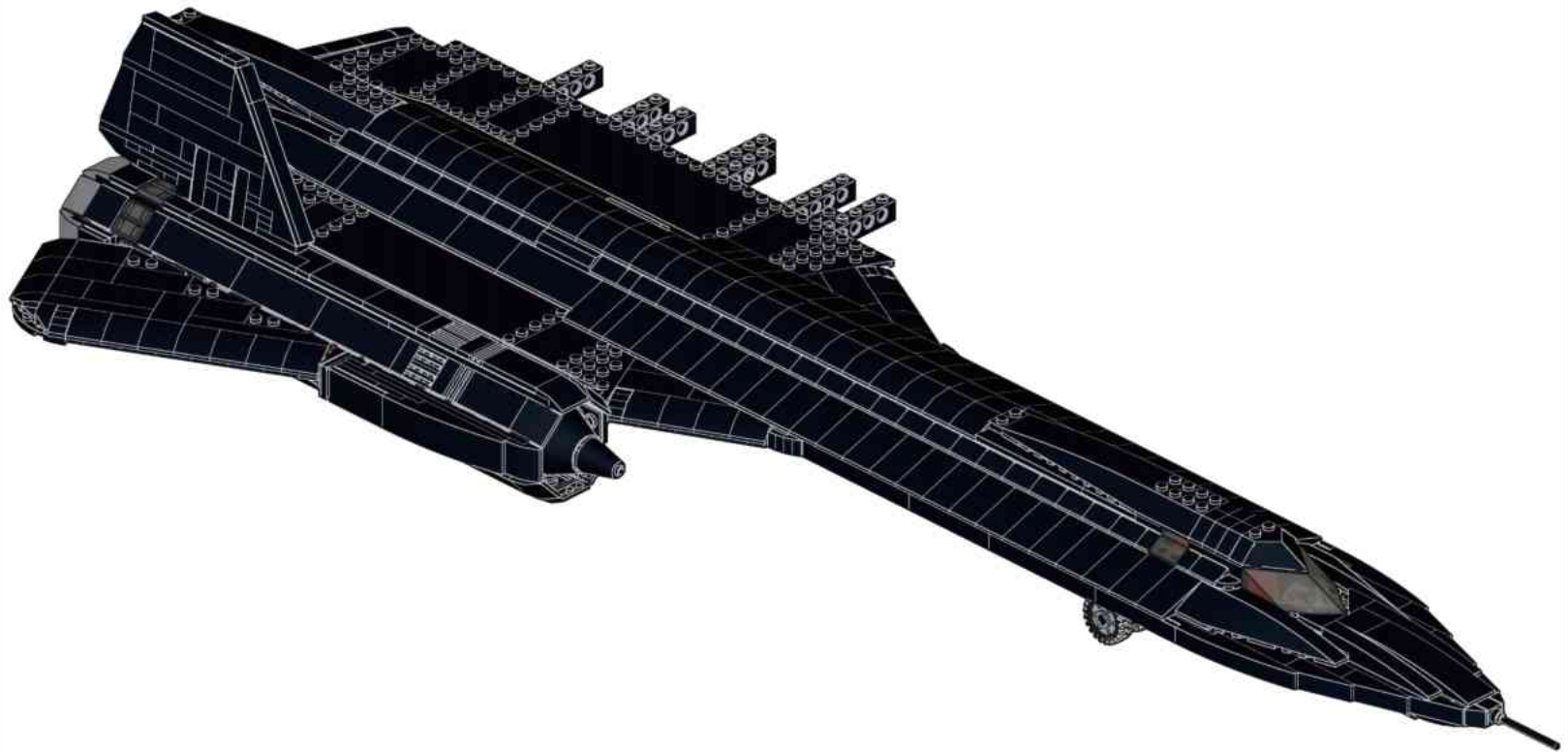

D



**D1**

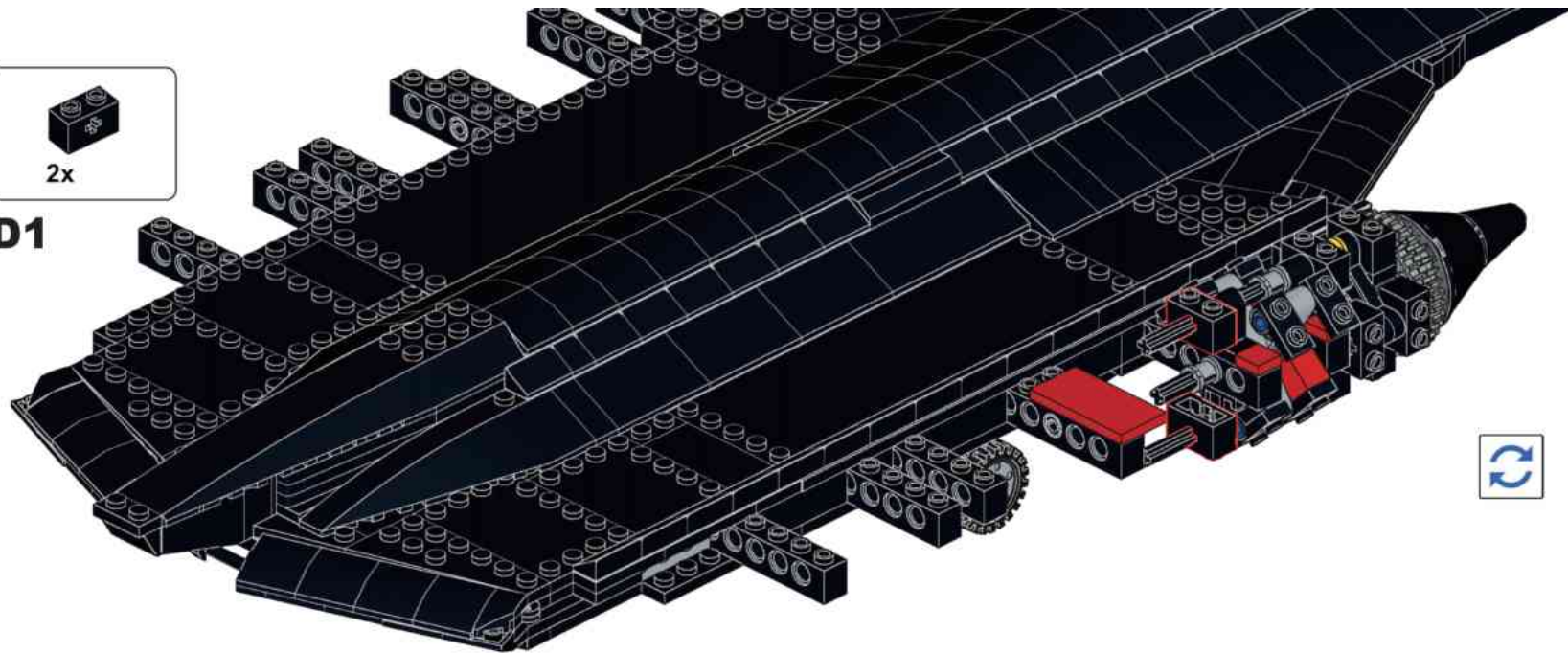

**D2**

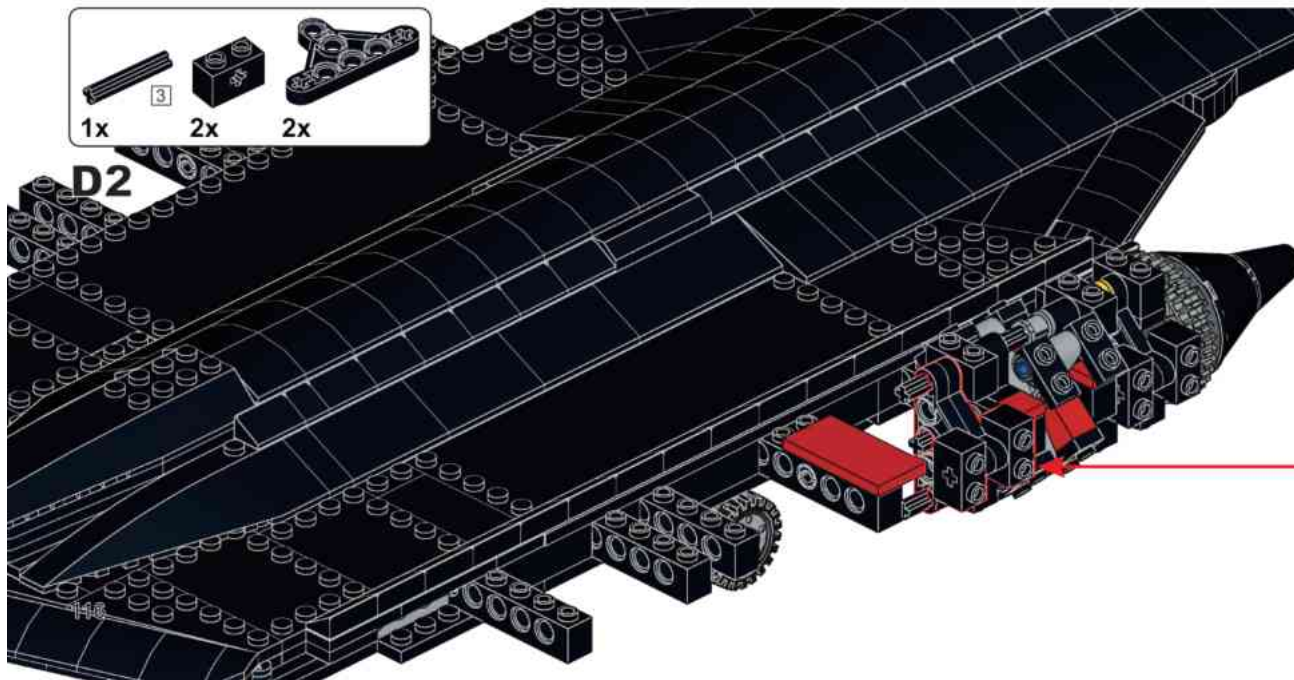

3 1:1

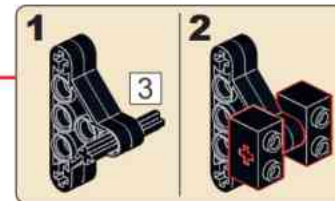

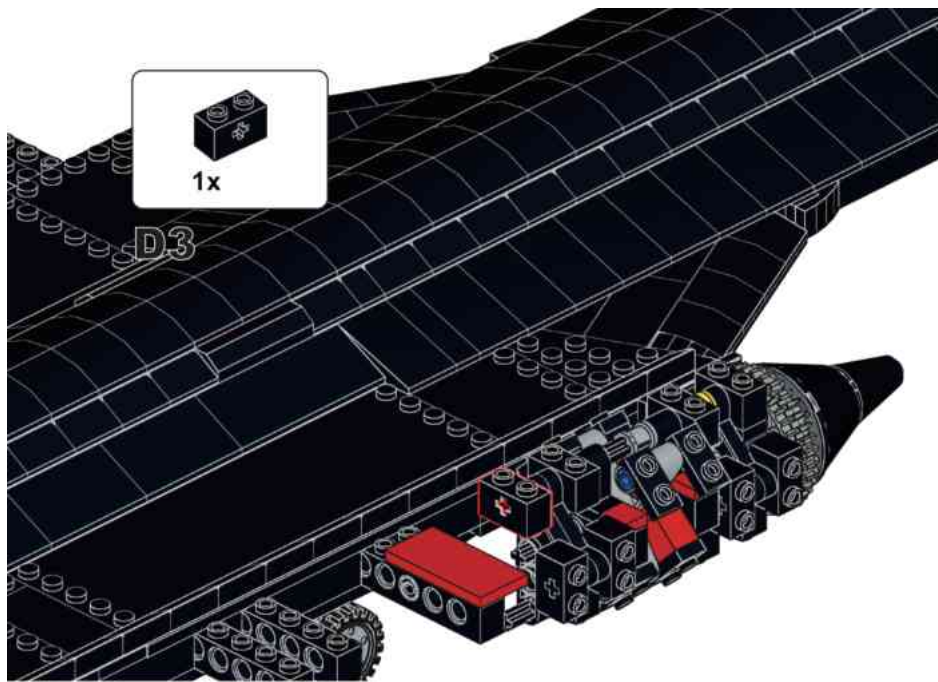

1x

D3

2x 1x

D4

5 1:1



2x

D5



2x 1x

D6



**D7**

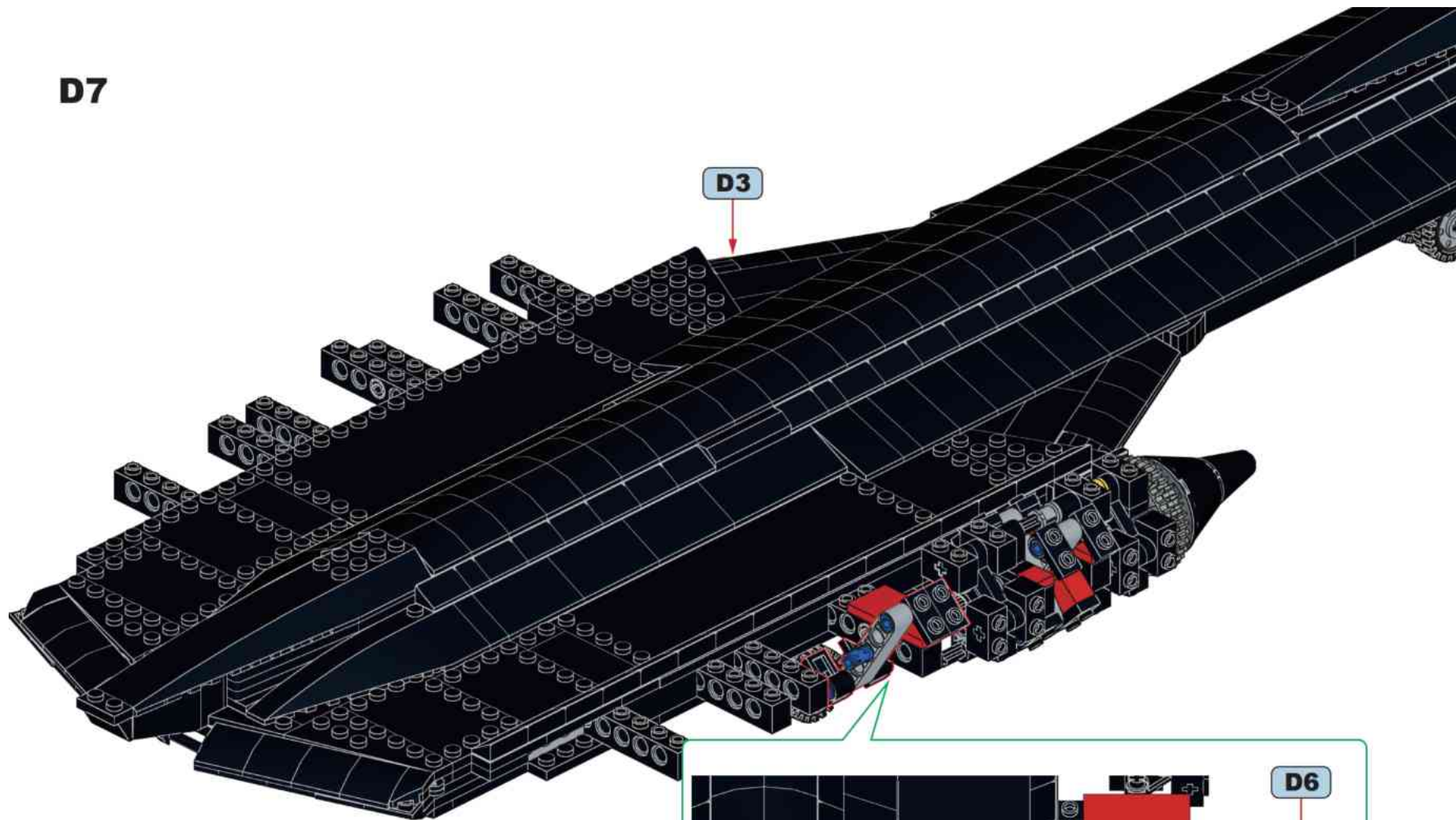

**D3**

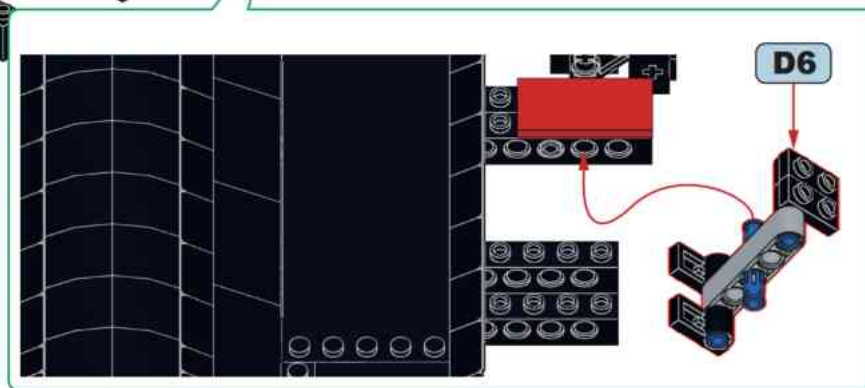

**D6**

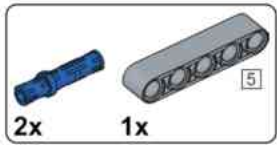

**D8**



**D9**

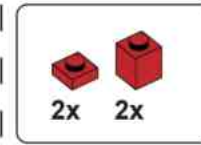
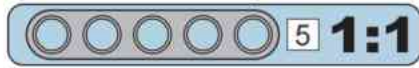

**D10**

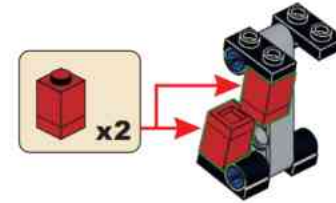

**D11**

**D7**

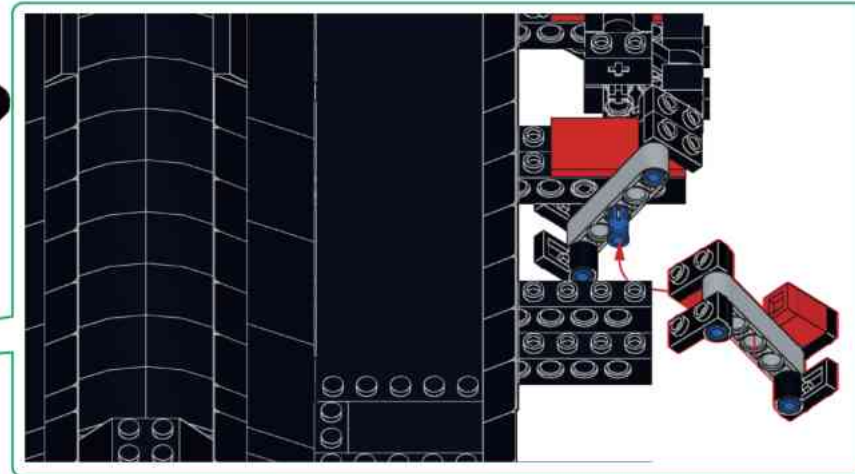
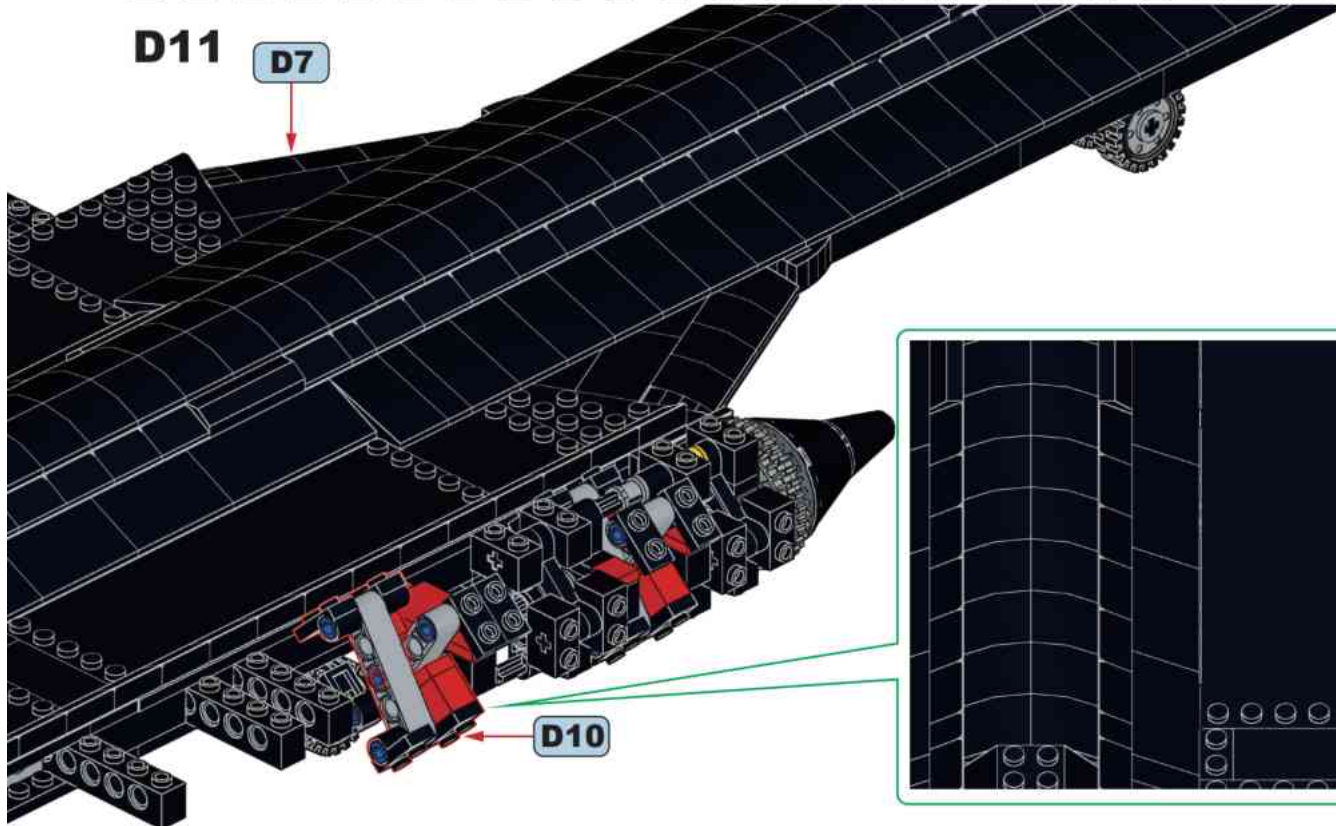

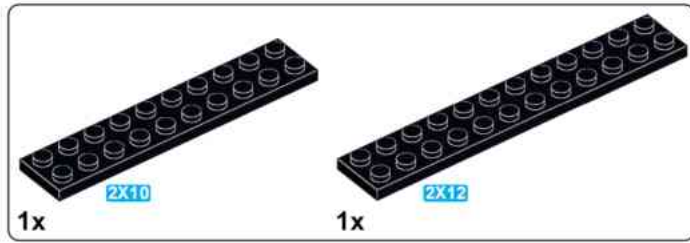

**D12**



**D14**

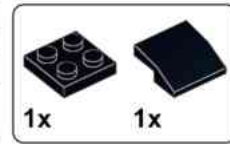
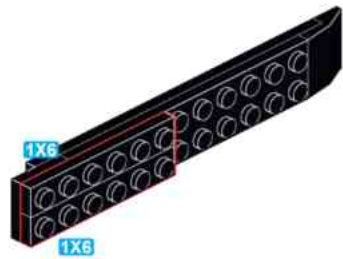

**D13**

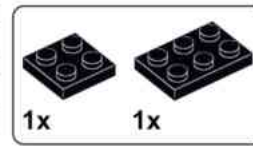
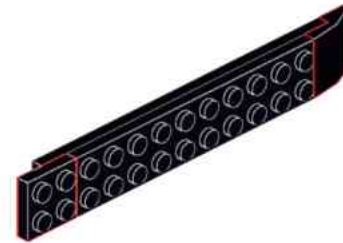

**D15**

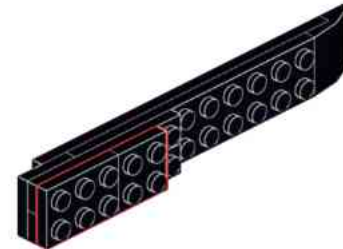

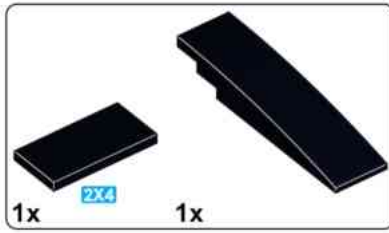

**D16**

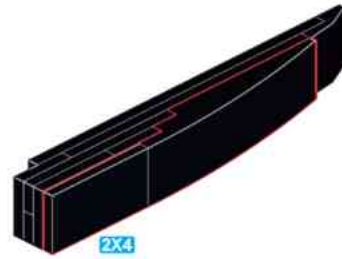

**D17**

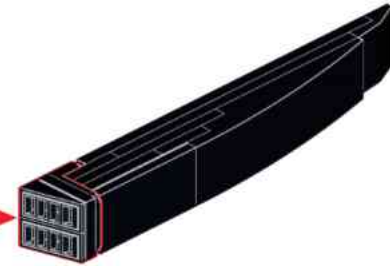
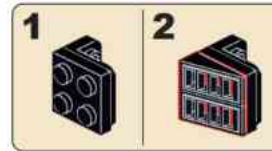

**D18**

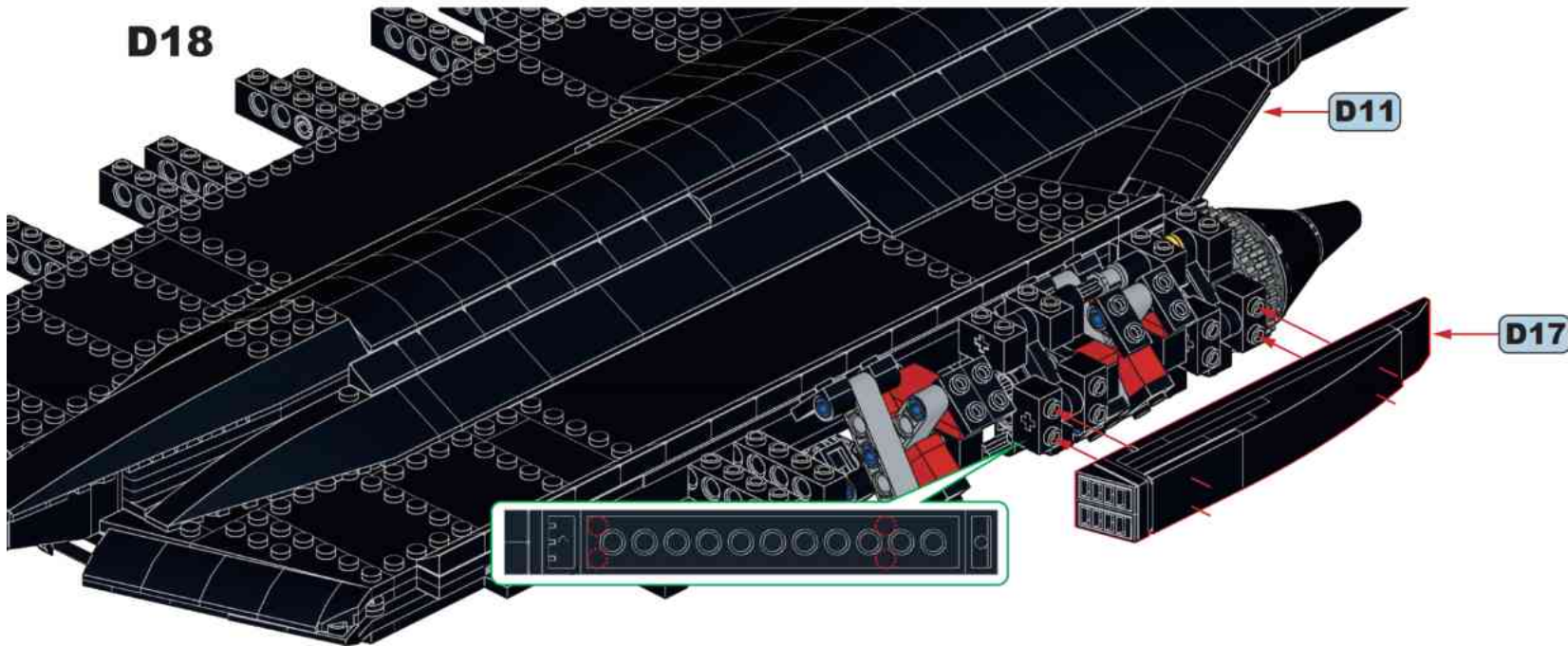

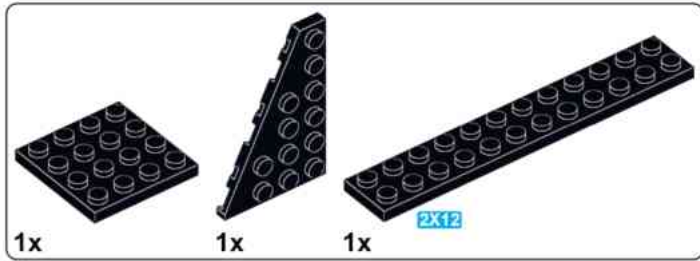

**D19**

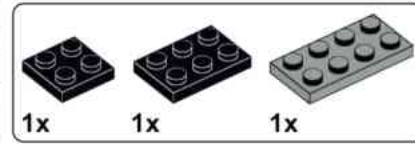

**D20**

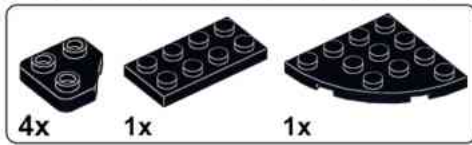

**D21**

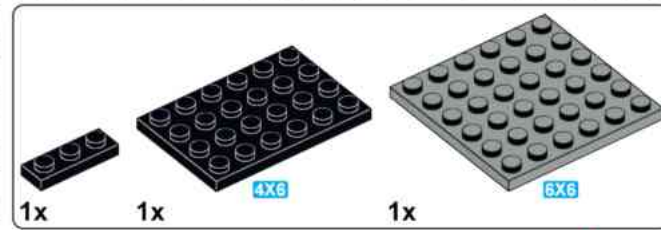
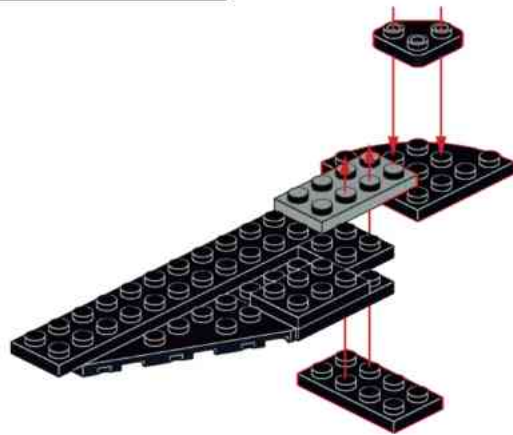

**D22**

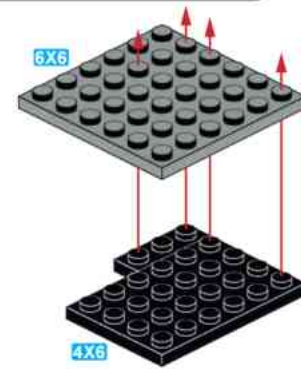

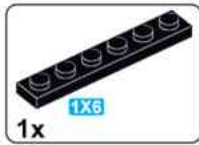

1x

### D23

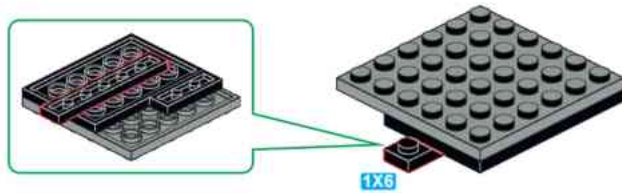

1x6

### D24

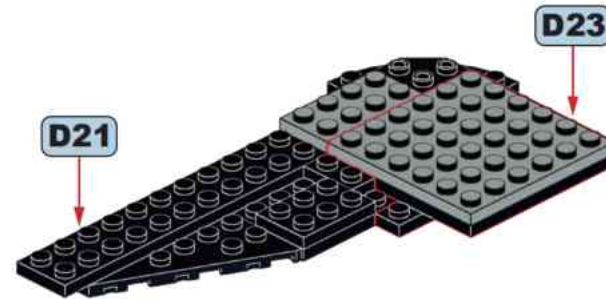

D21

D23

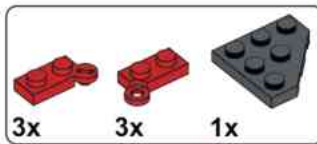

3x

3x

1x

### D25

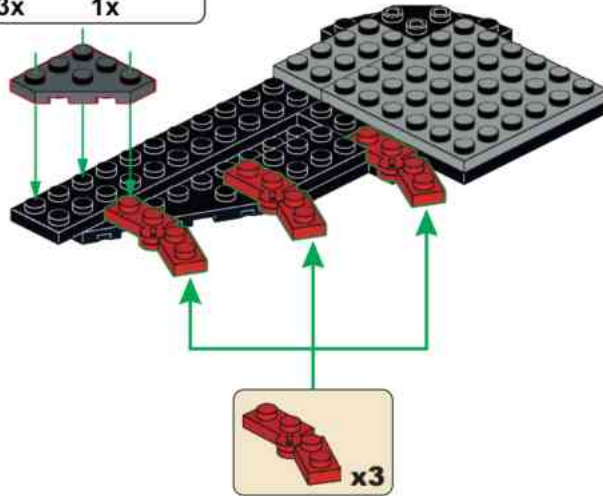

x3

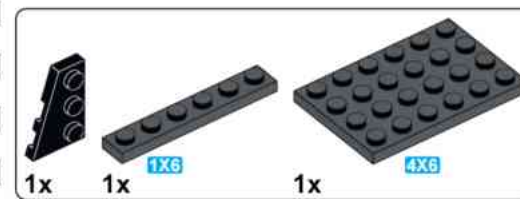

1x

1x

1x6

1x

4x6

### D26

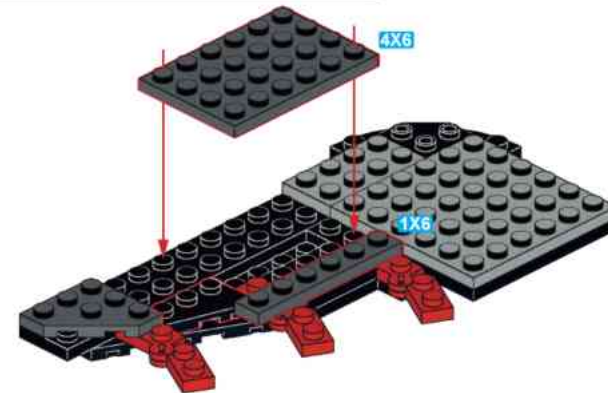

4x6

1x6



**D27**

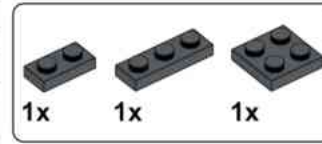
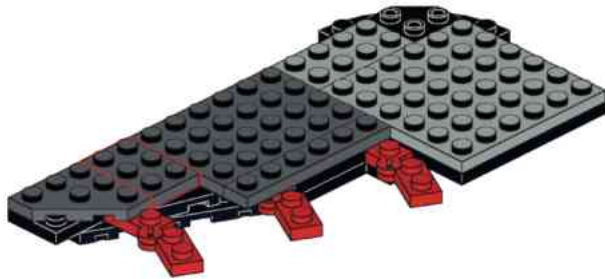

**D28**

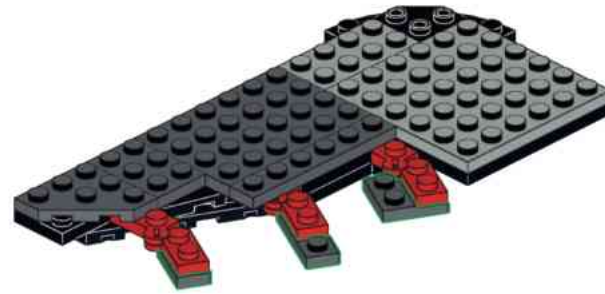

**D29**

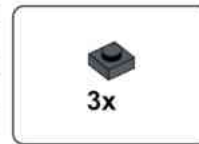
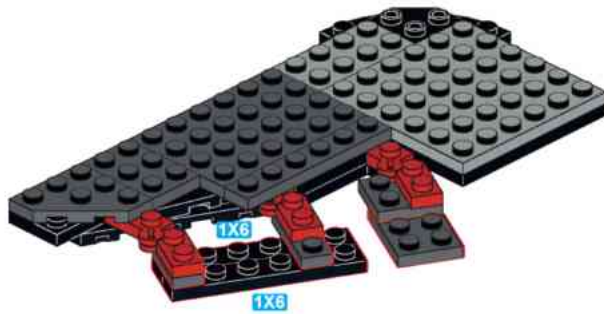

**D30**

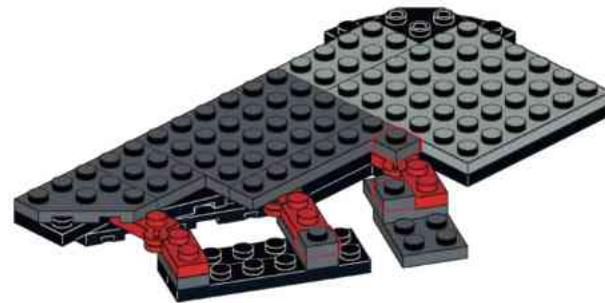

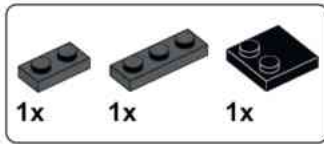

**D31**

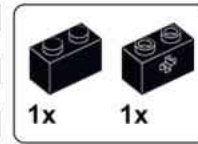

**D32**

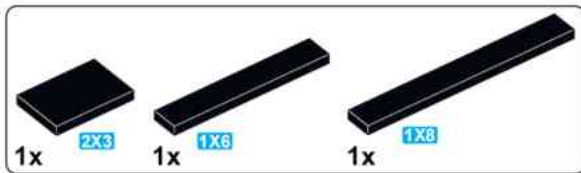
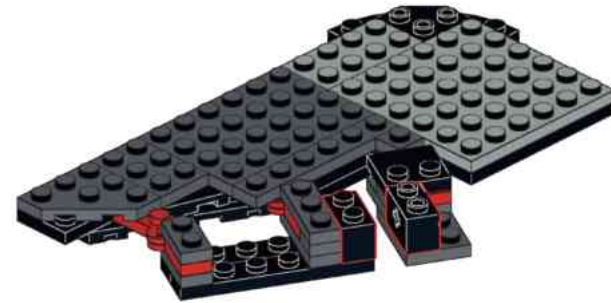

**D33**

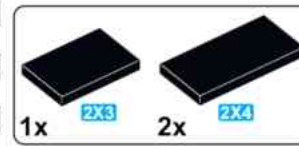
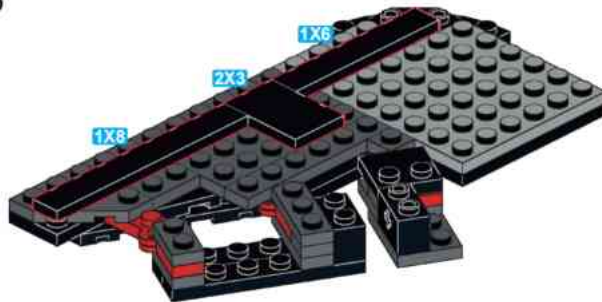

**D34**

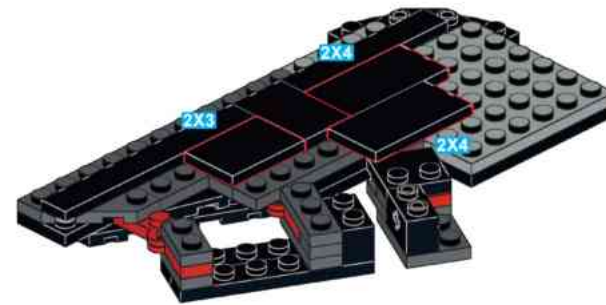

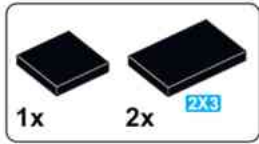

**D35**

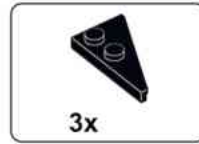
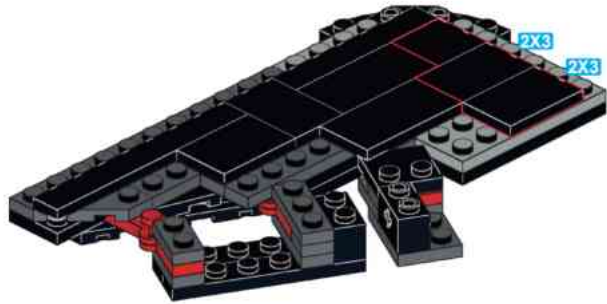

**D36**

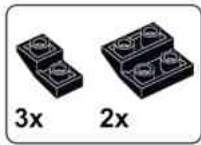

**D37**



**D38**





**D39**

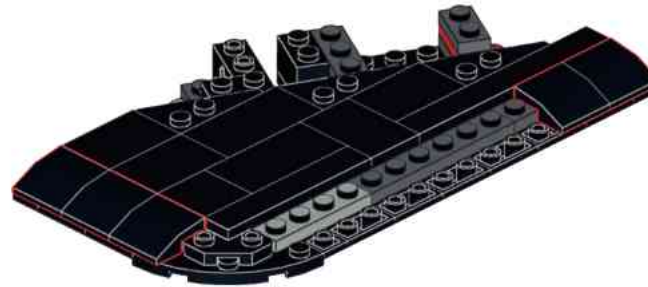

**D40**

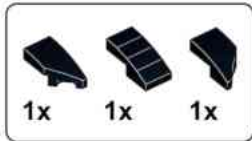

**D41**



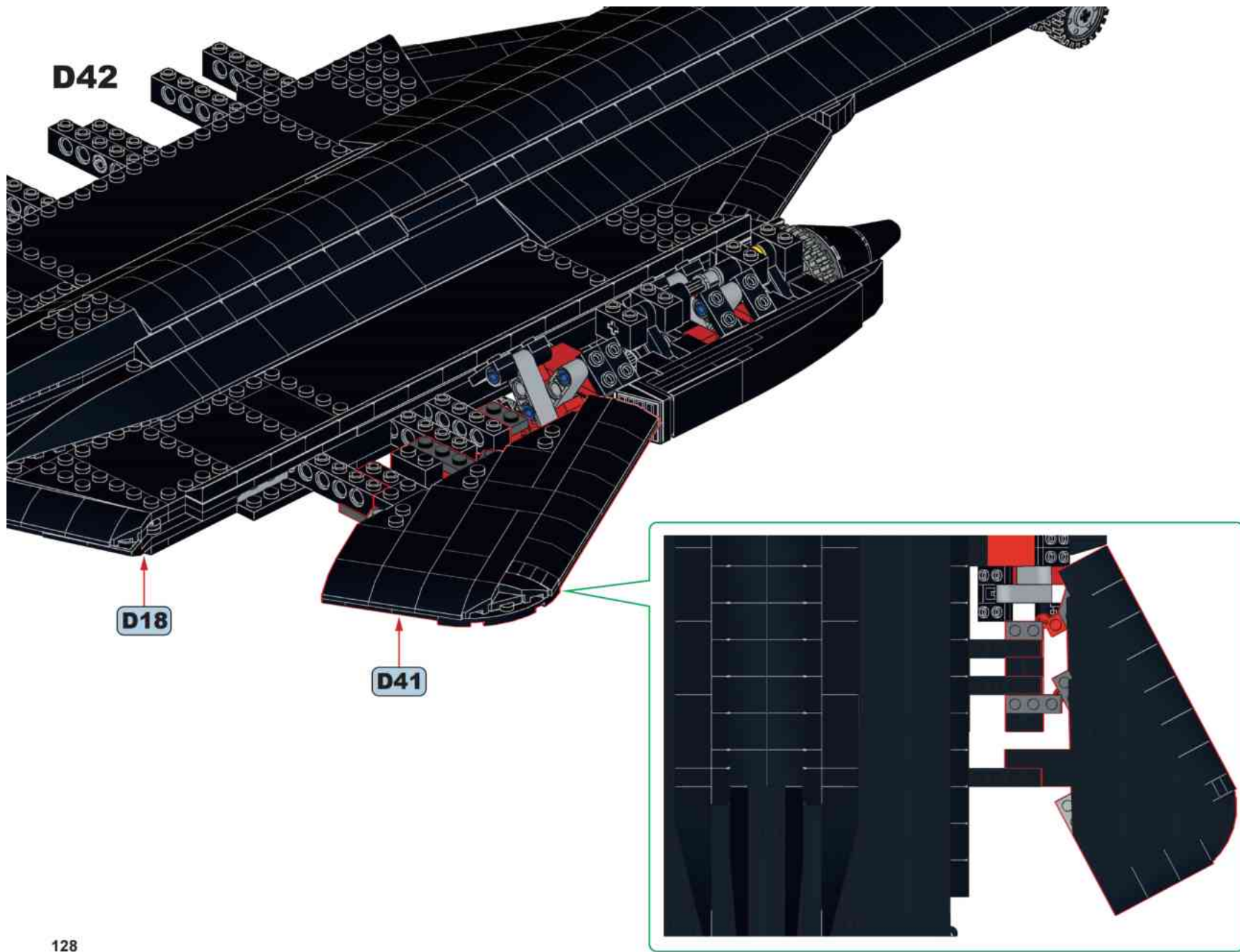



### D43

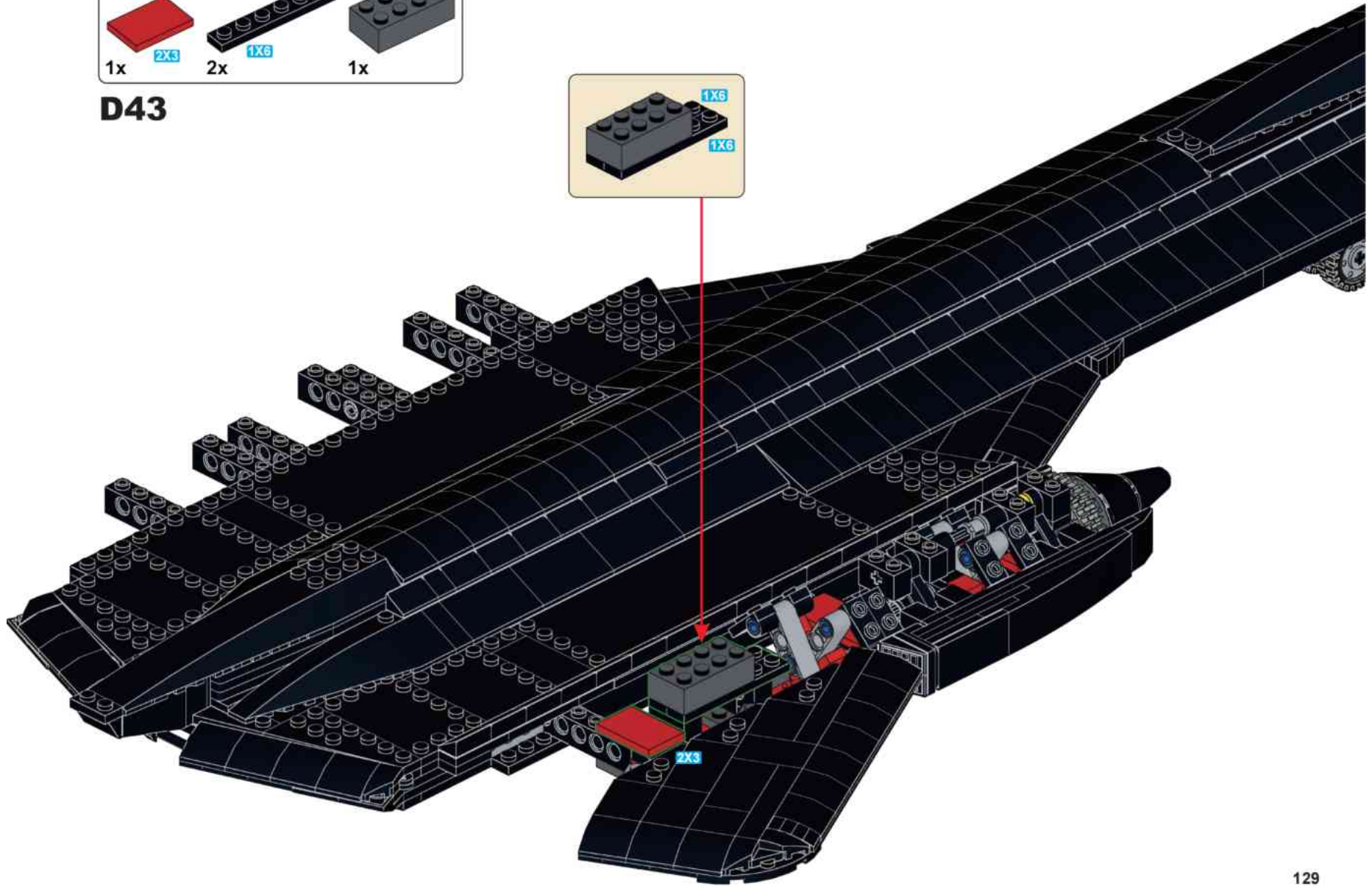
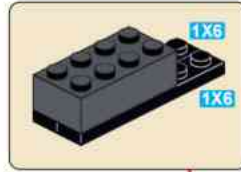

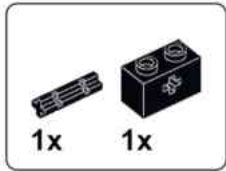

**D44**

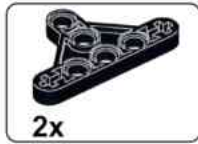

**D45**

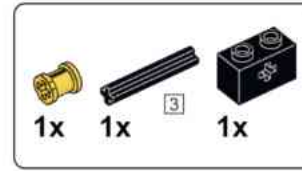

**D46**

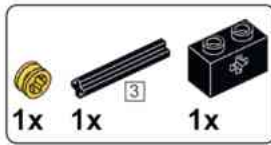

**D47**

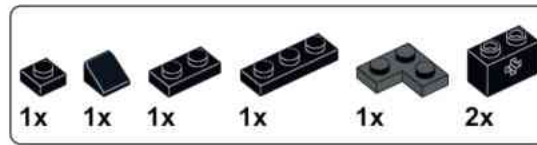

**D48**

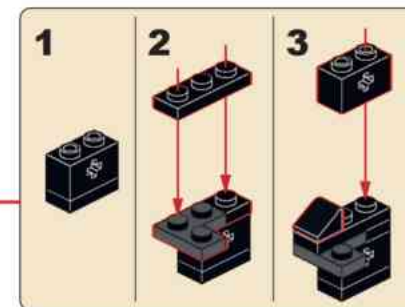
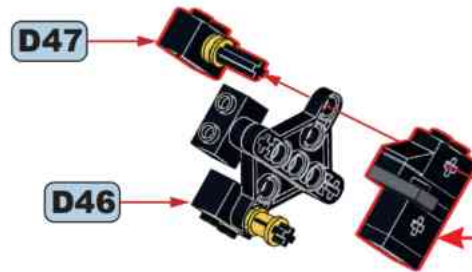

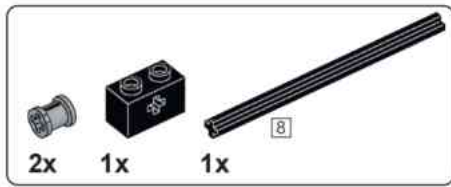

**D49**

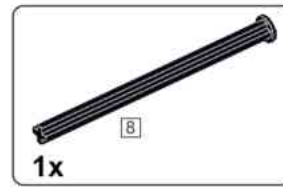
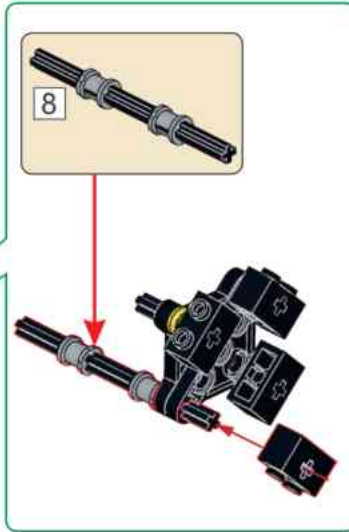
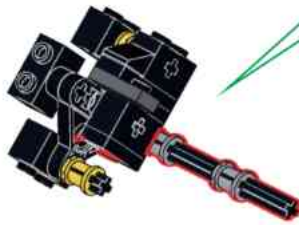

**D50**

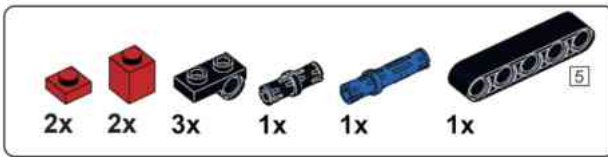
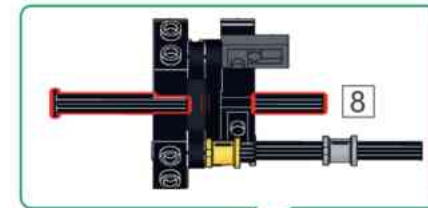
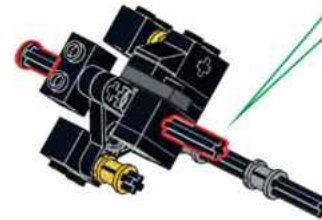

**D51**

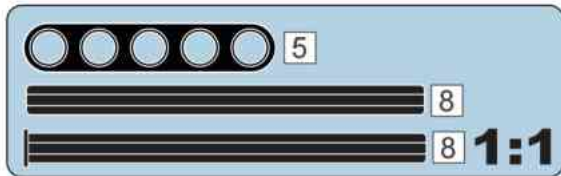
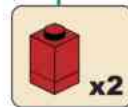

**D52**

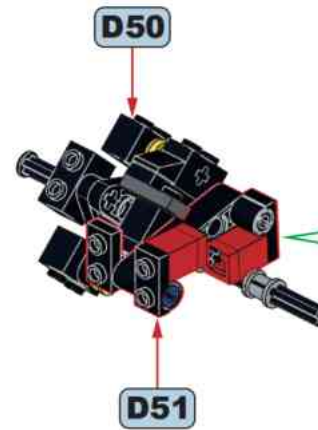

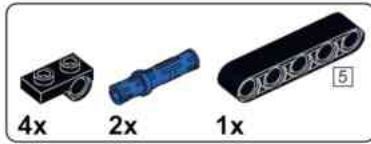

### D53

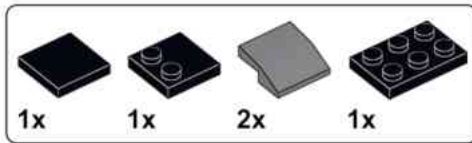
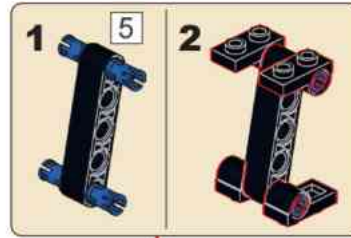

### D54

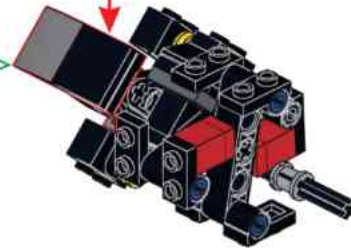
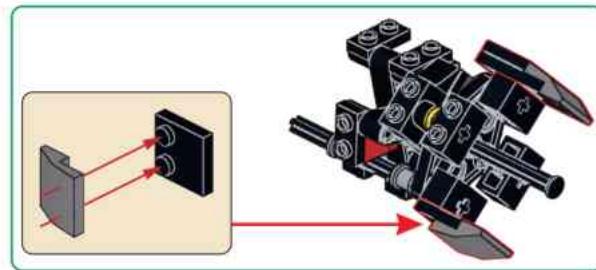
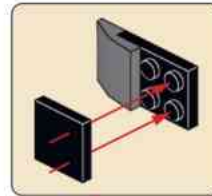

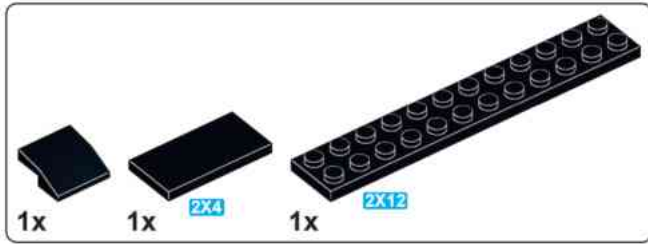

**D55**

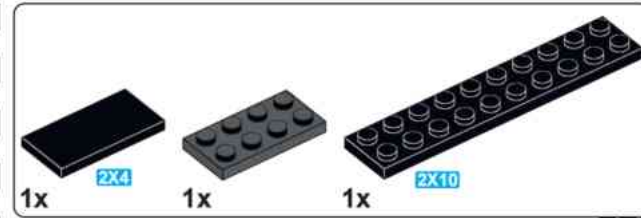
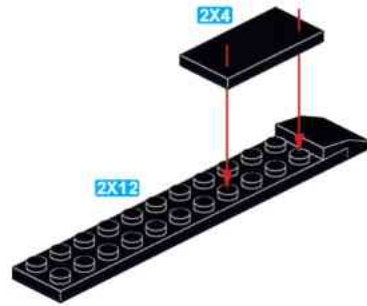

**D56**

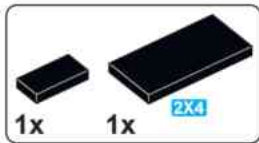
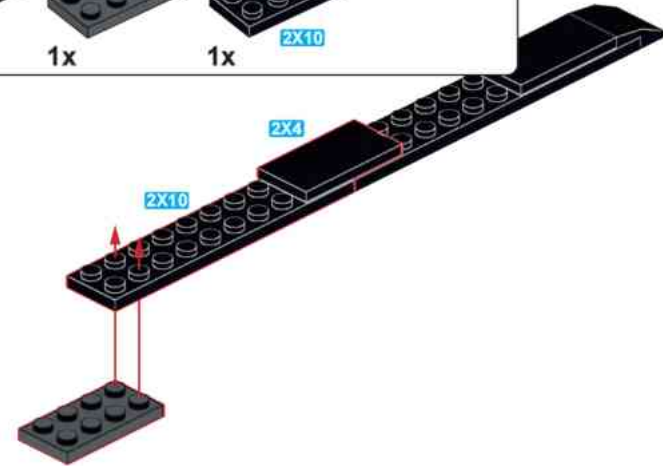

**D57**

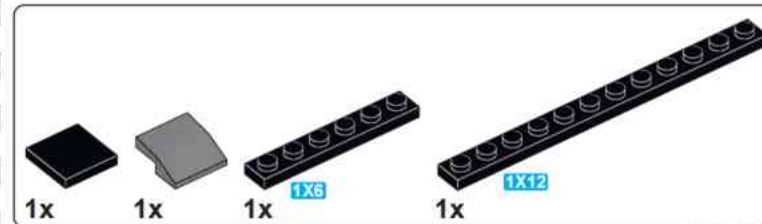
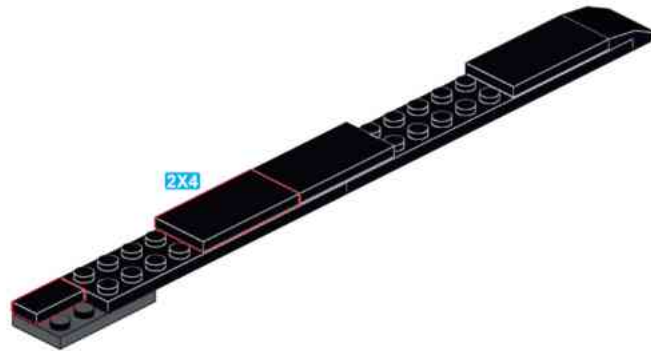

**D58**

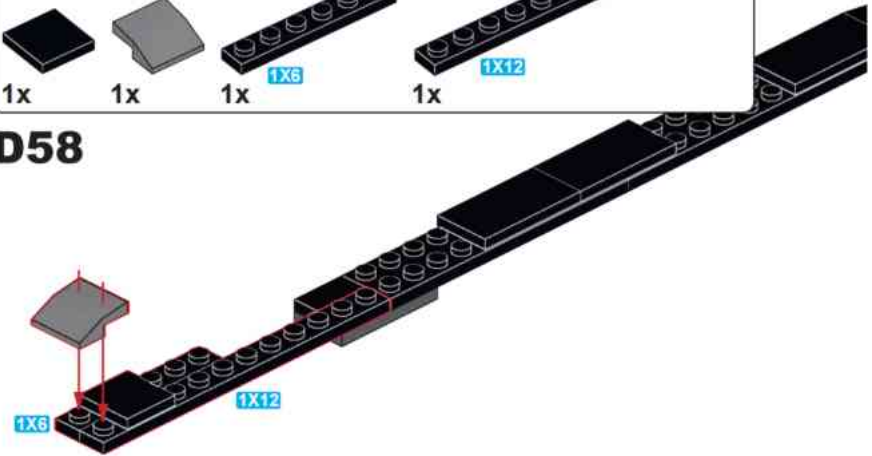

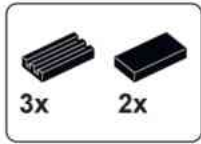

**D59**

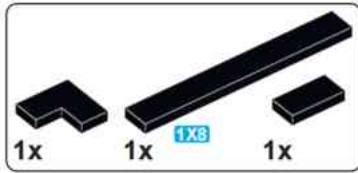

**D60**

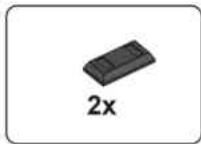

**D61**



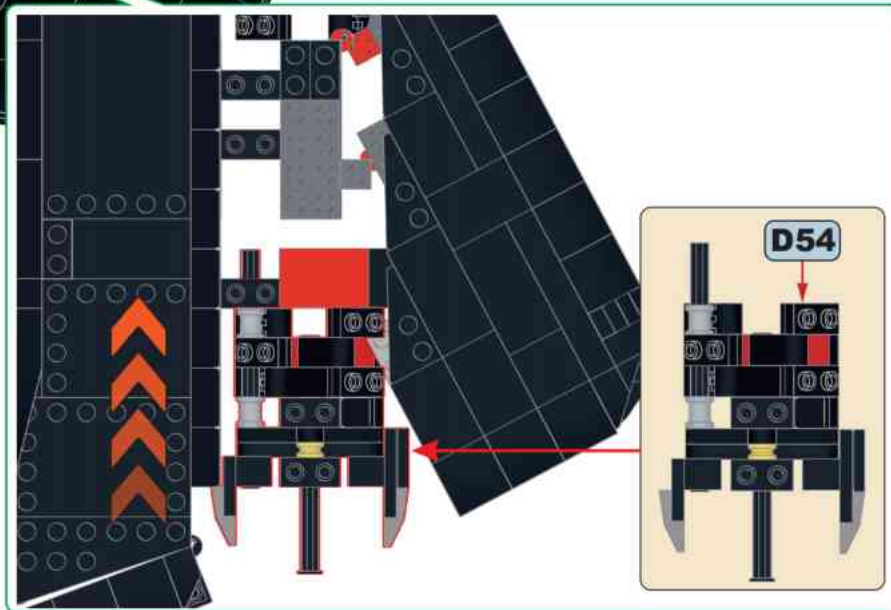
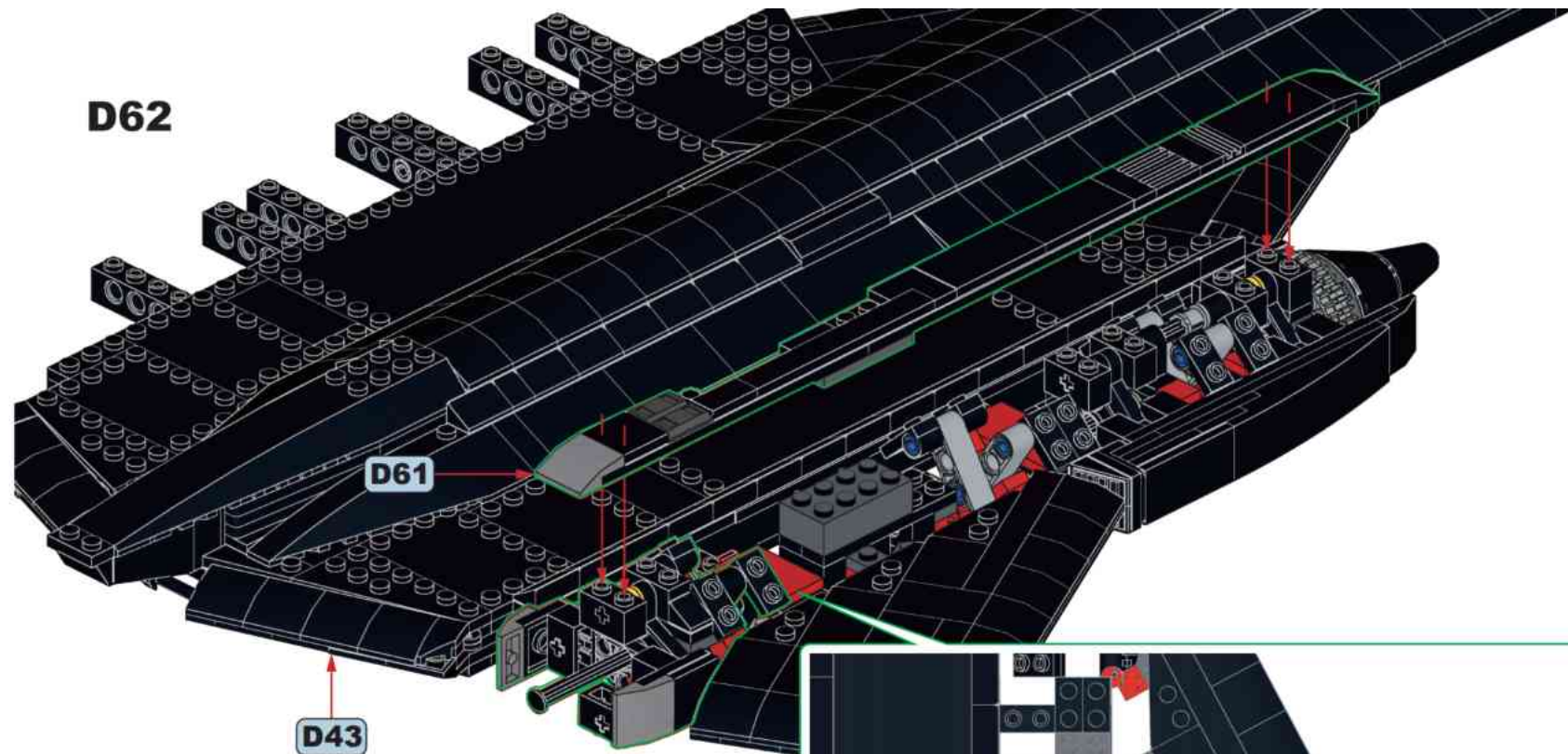

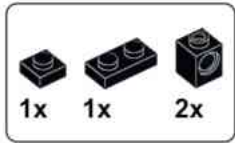

**D63**

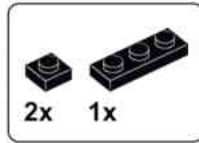

**D64**

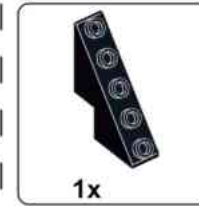
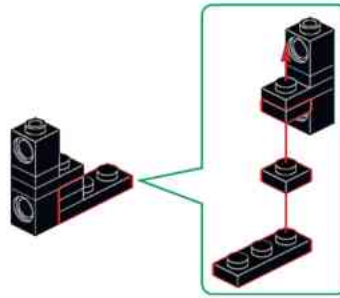

**D65**

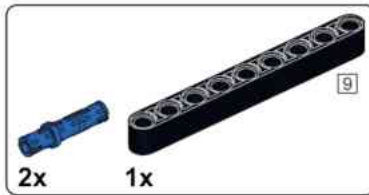

**D66**

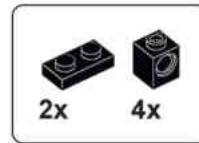
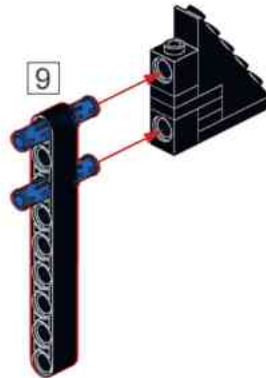

**D67**

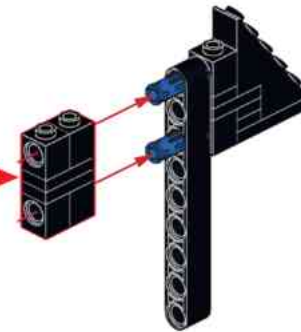
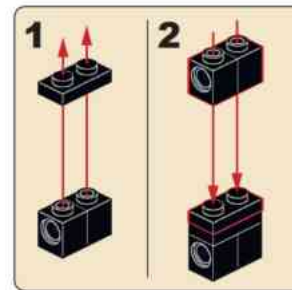

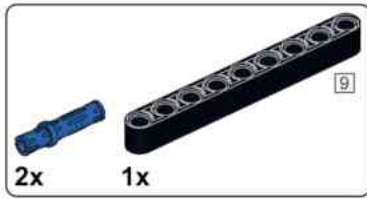

**D68**

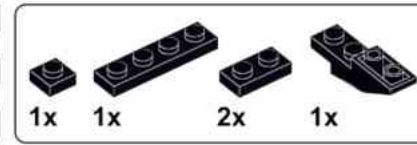
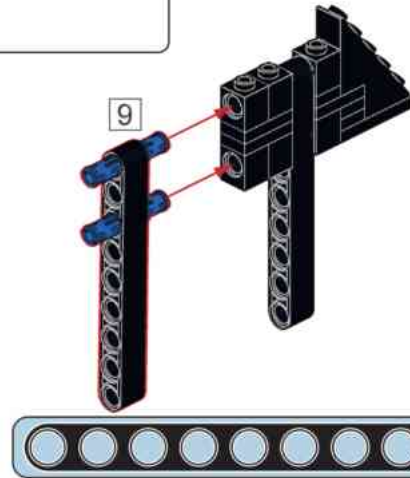

**D69**

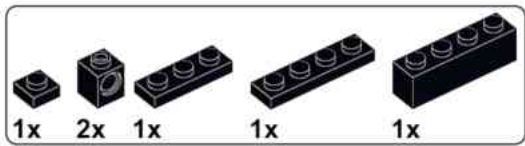
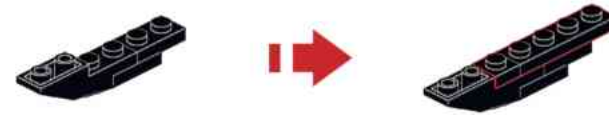

**D70**

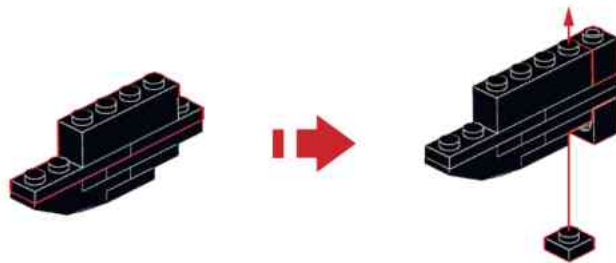

**D71**

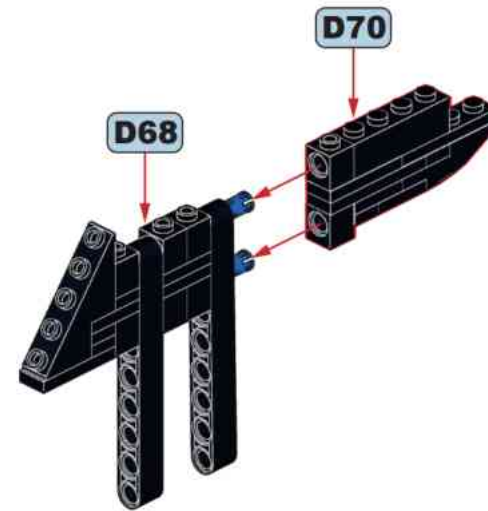

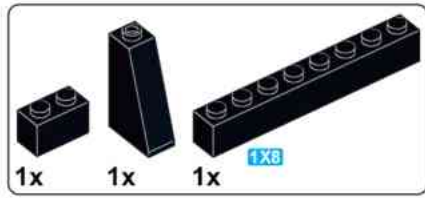

**D72**

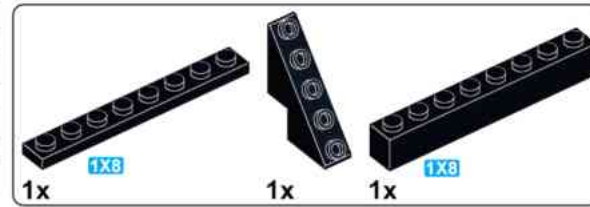
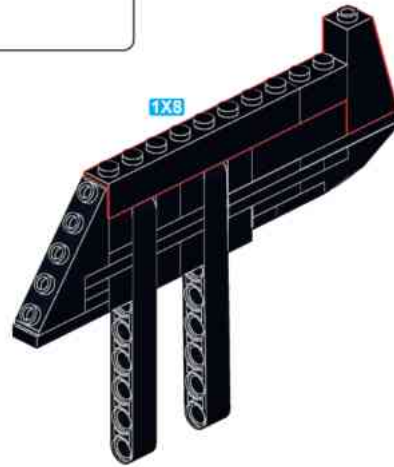

**D73**

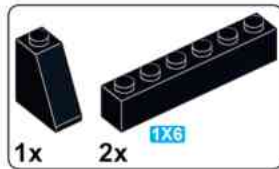
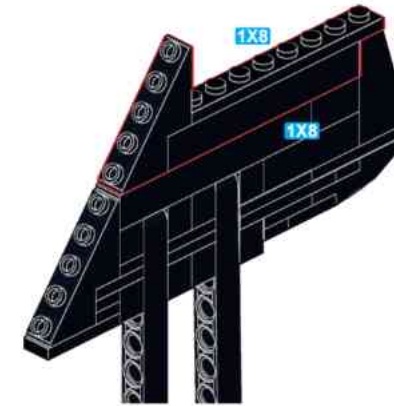

**D74**

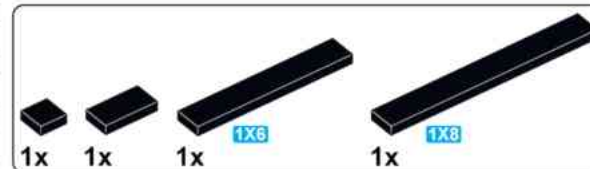
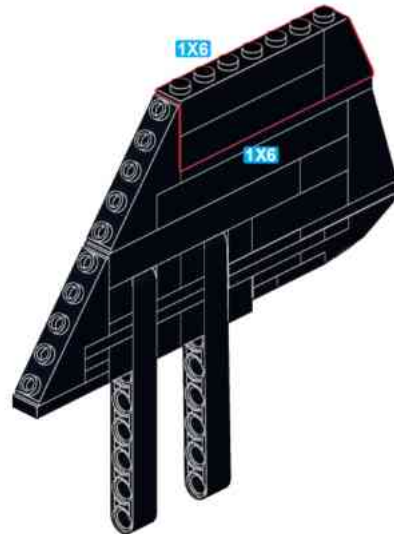

**D75**

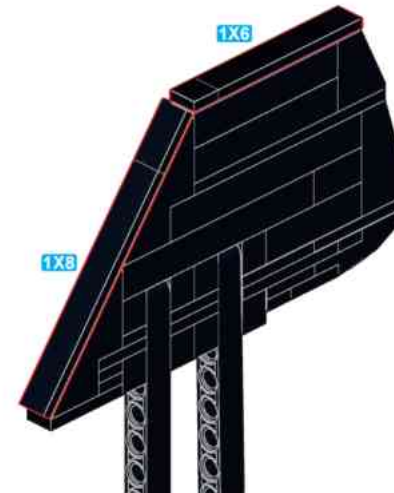

**D76**

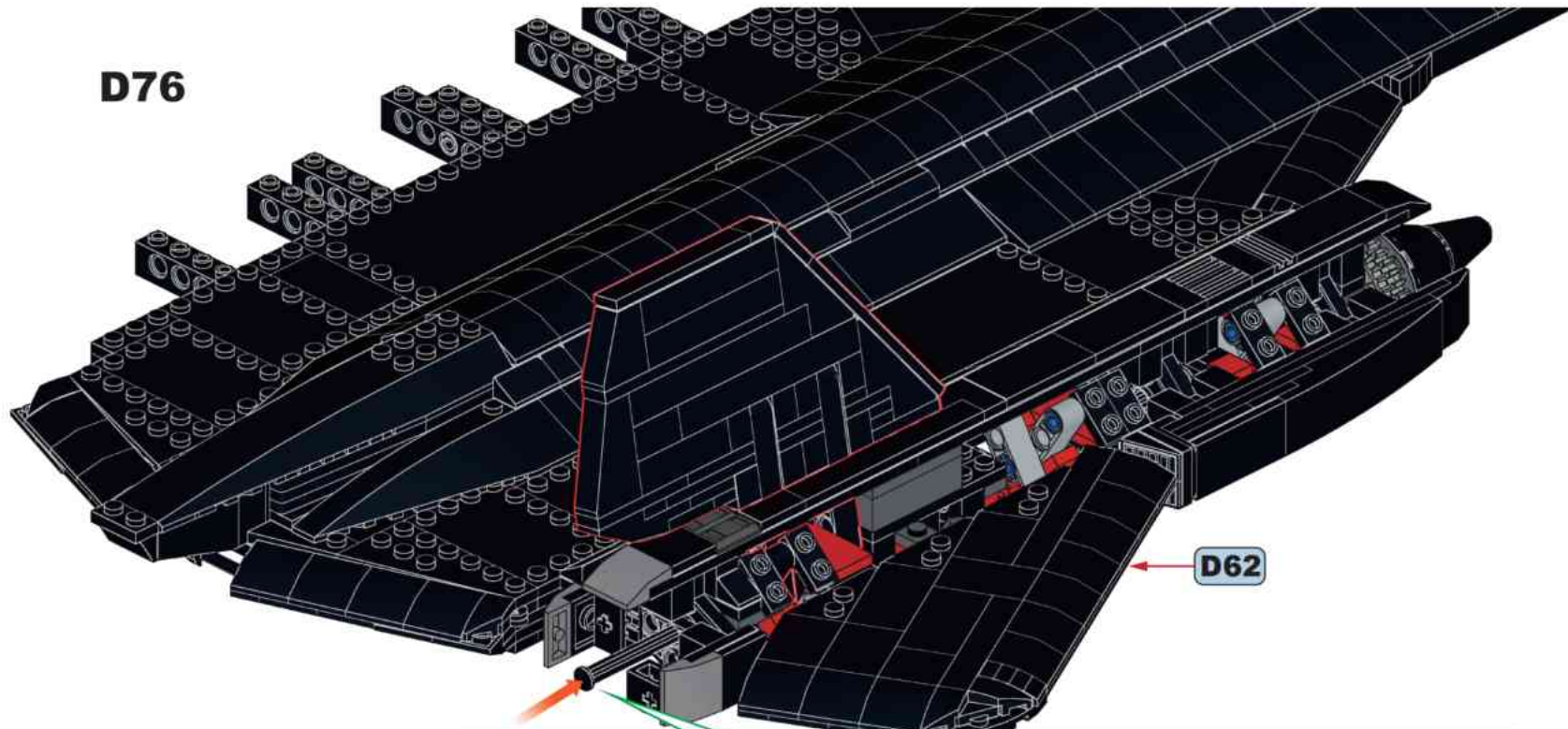

**D62**

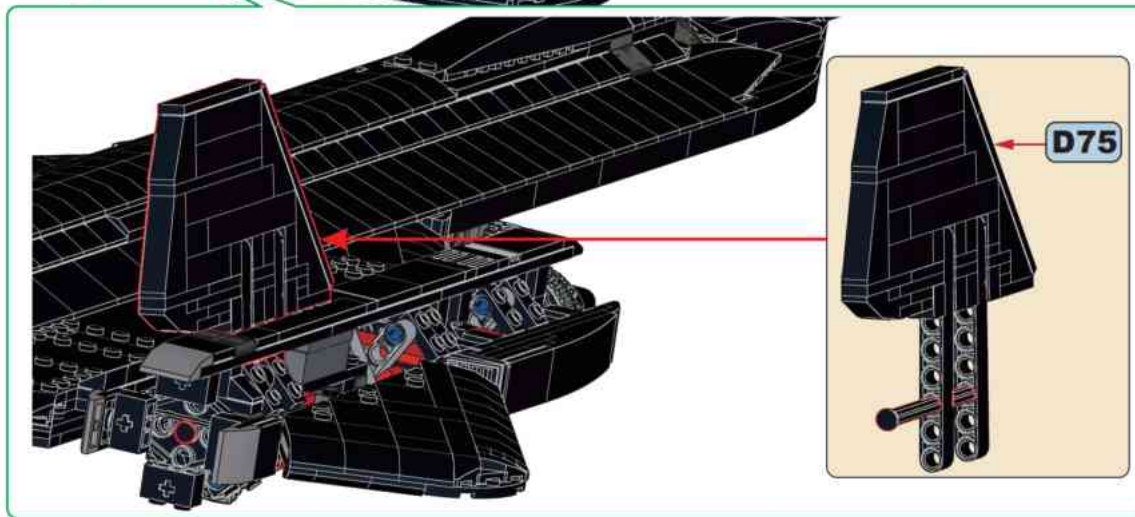

**D75**

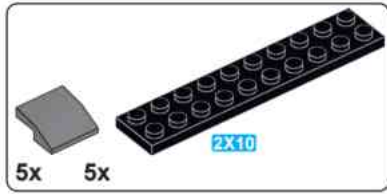

**D77**

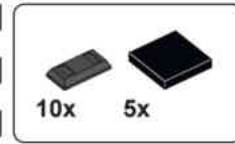

**D78**



**x5**

**x5**

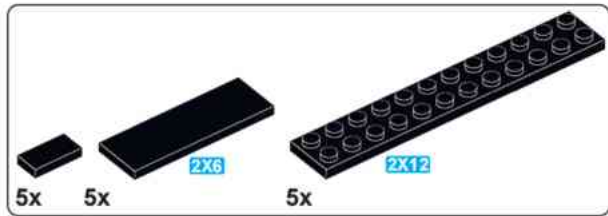

**D79**



**x5**

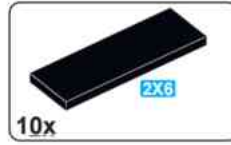

**D80**

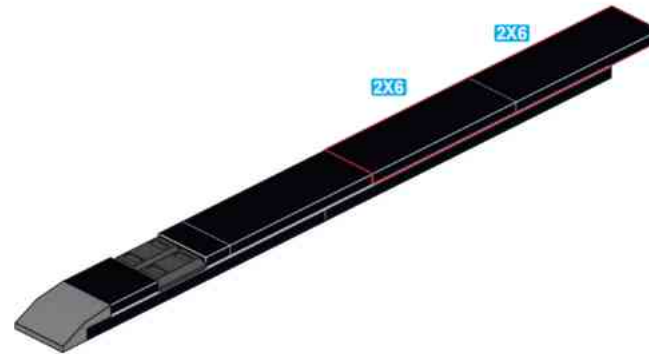

**x5**



**D81**

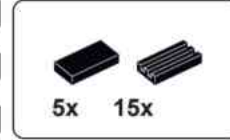

**D82**

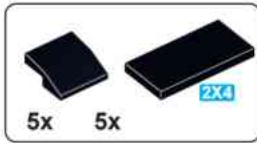

**D83**



**x5**

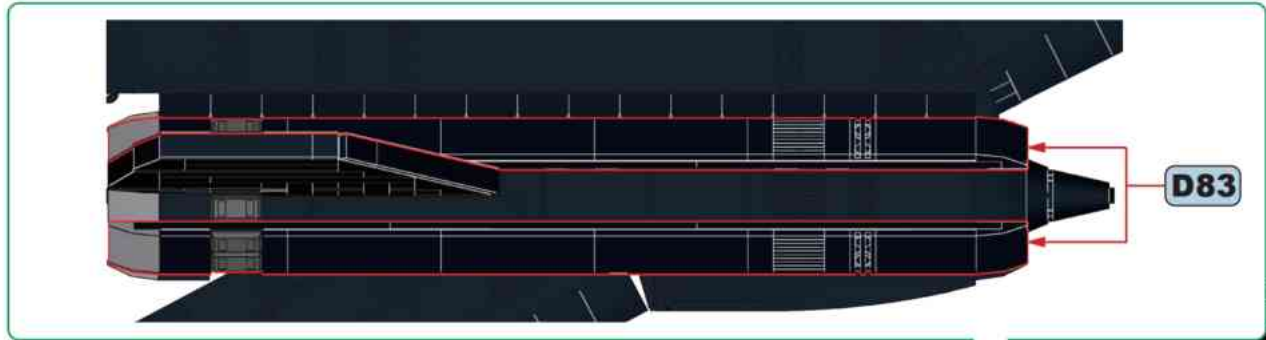

**D84**

**D76**

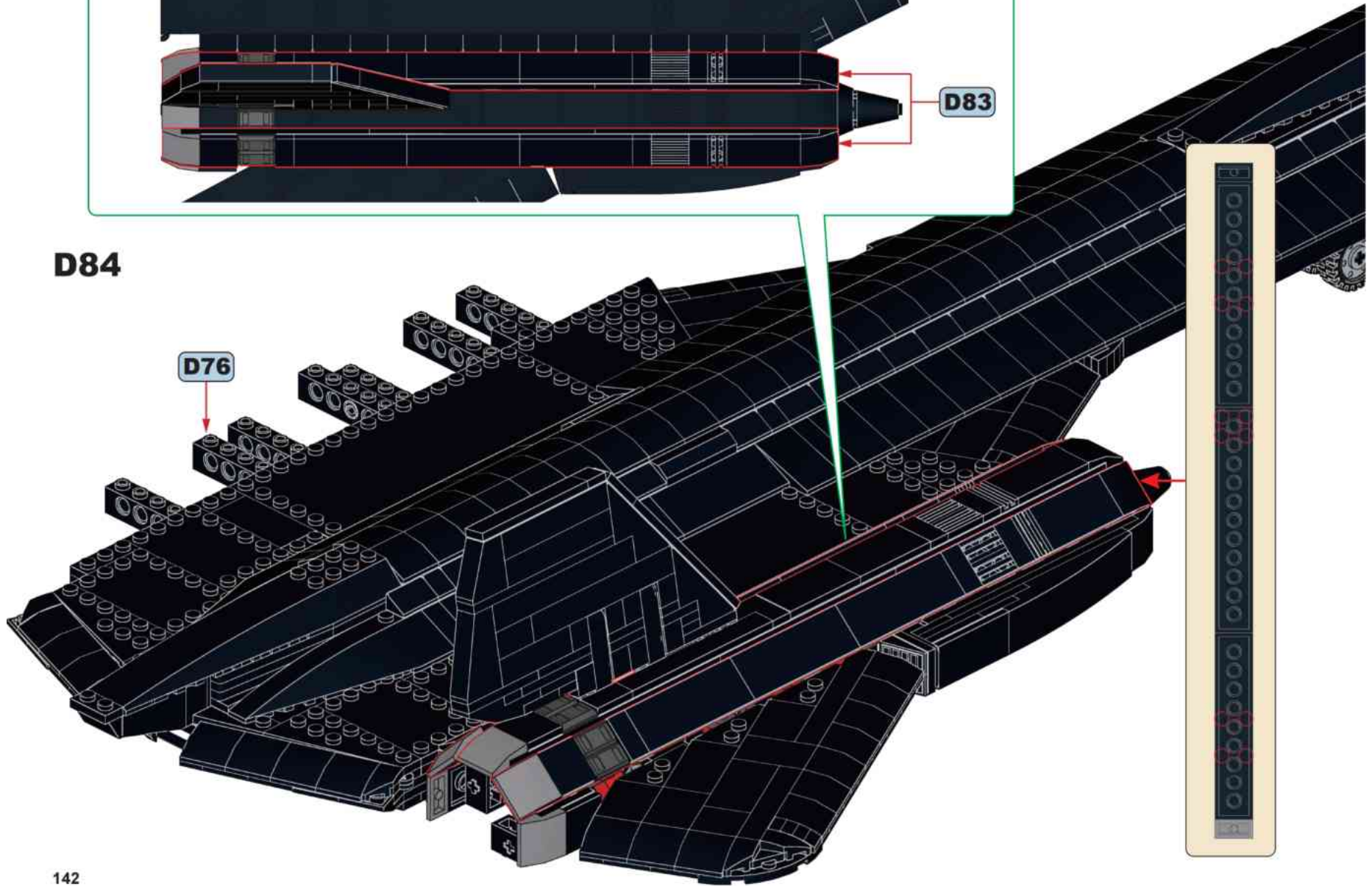

D85

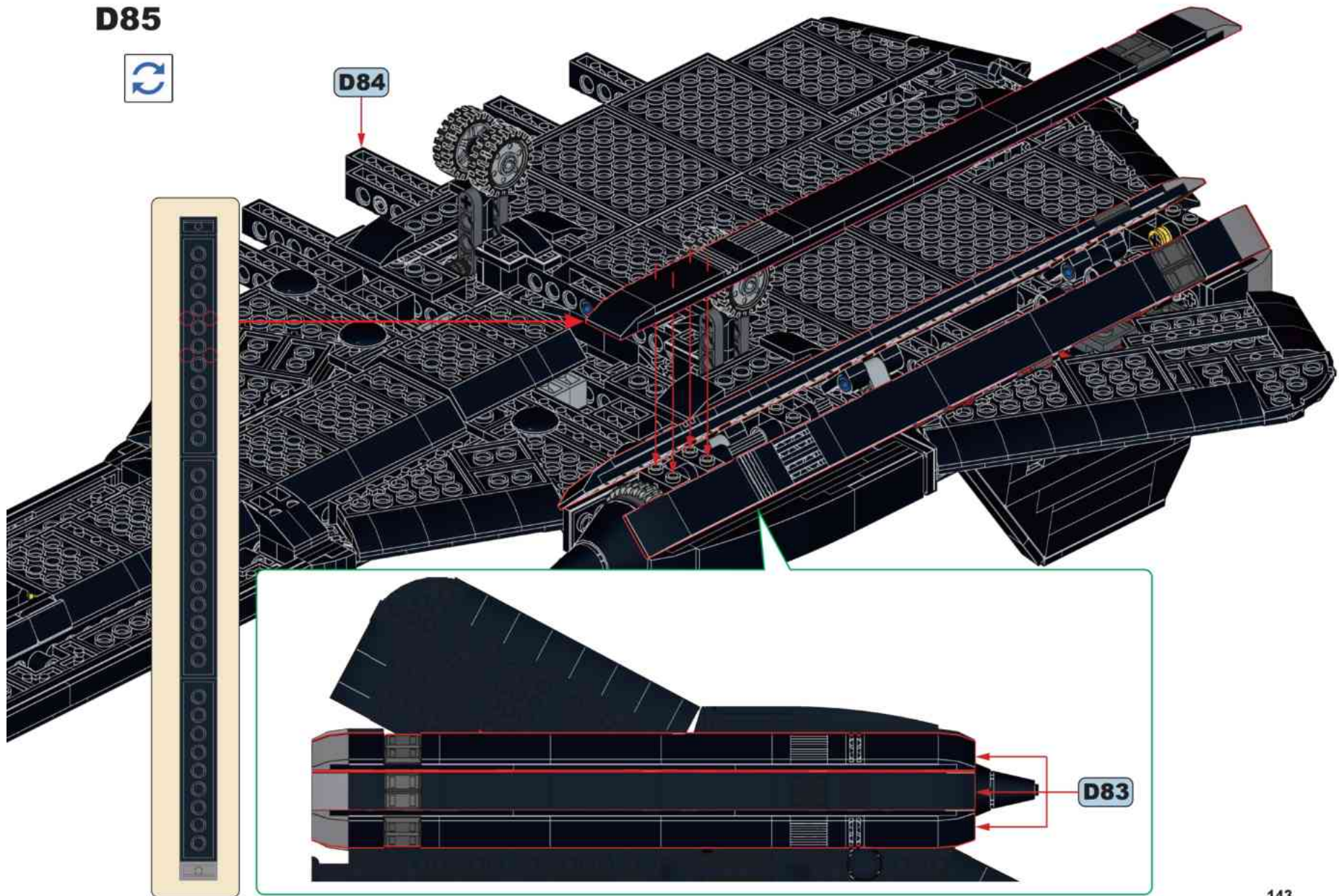

5



E

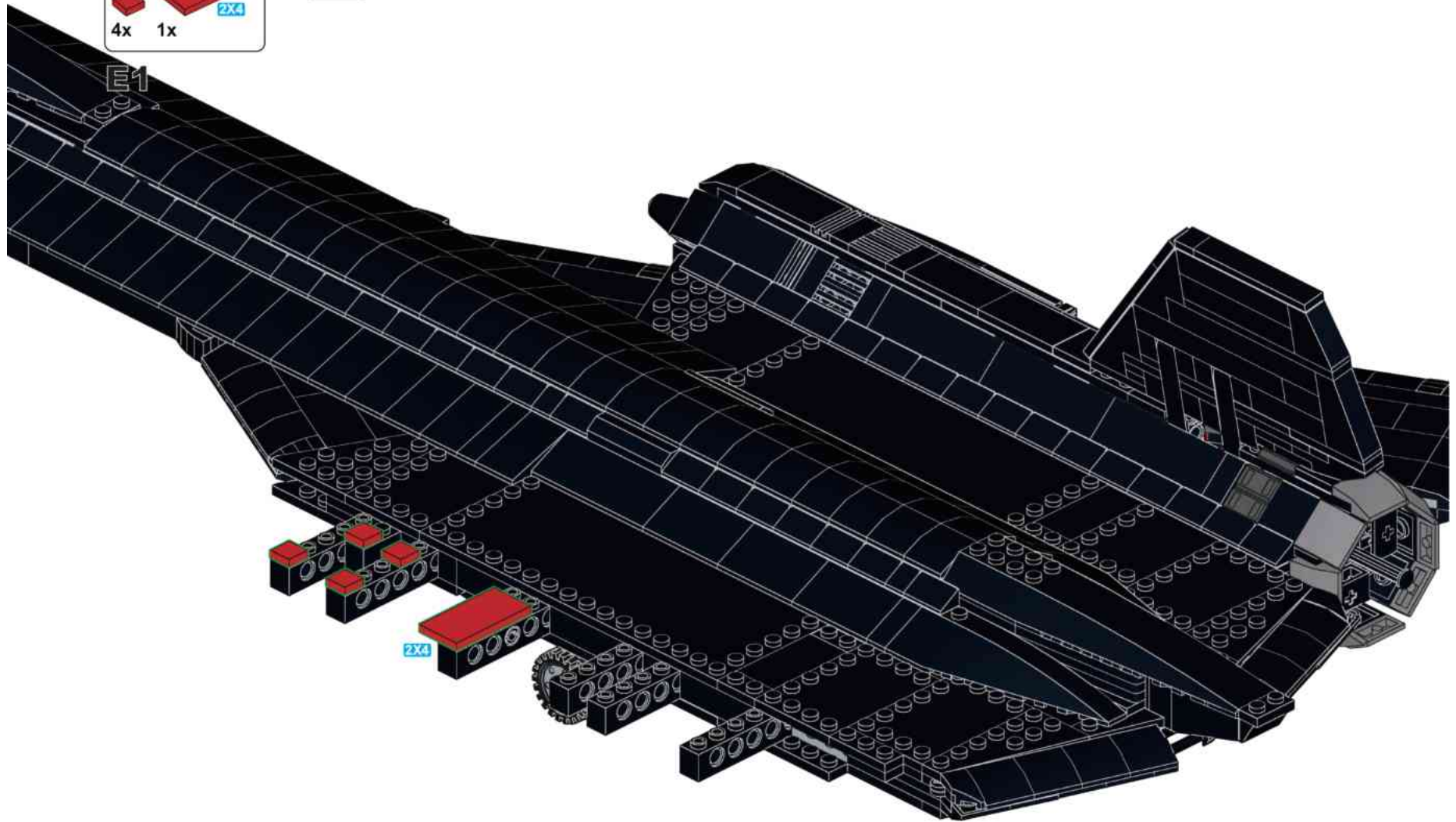
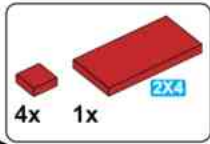

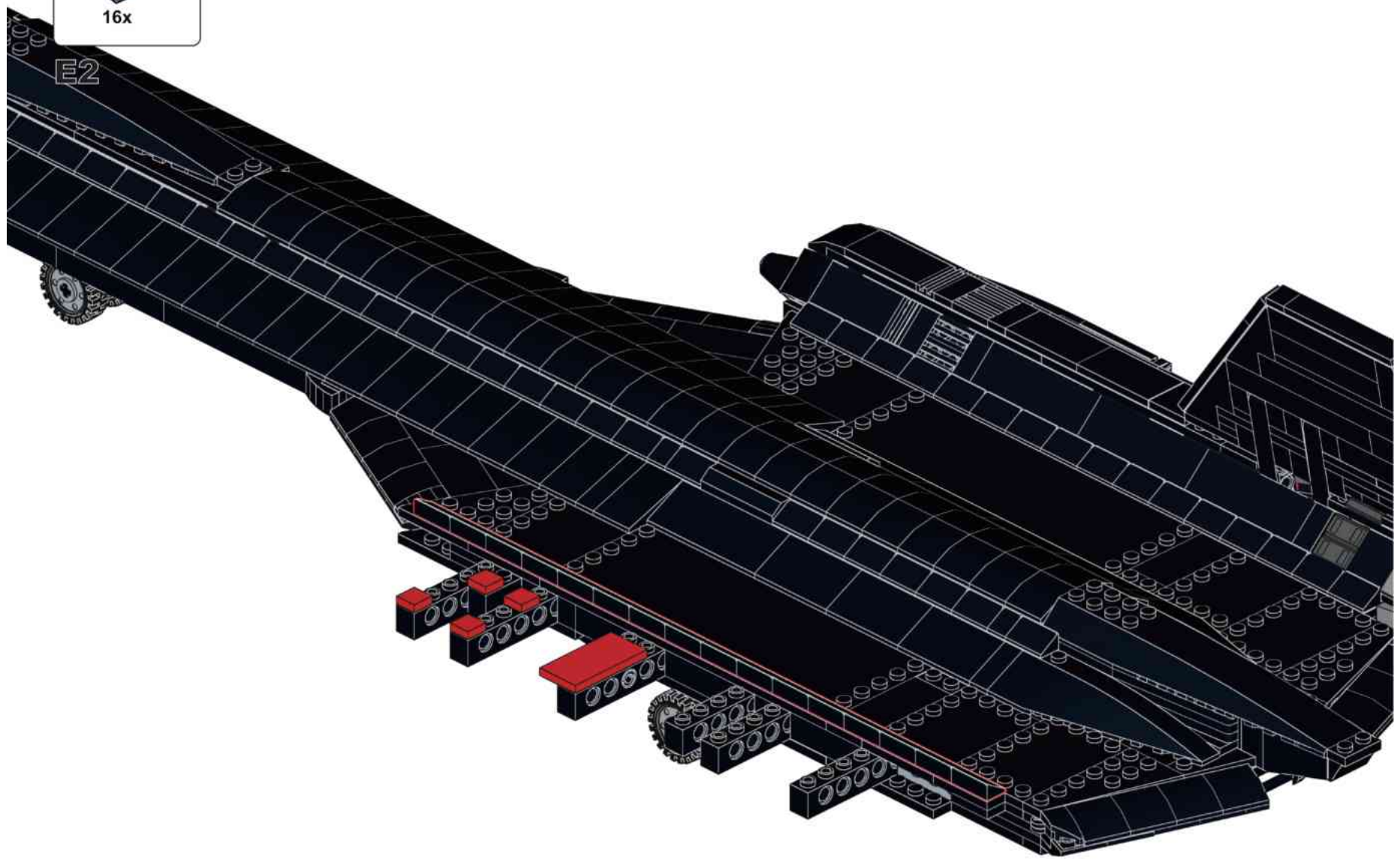

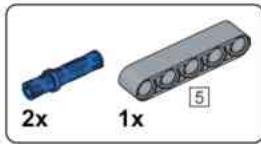

**E3**



**E4**

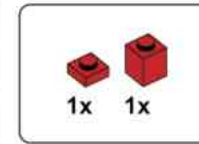

**E5**

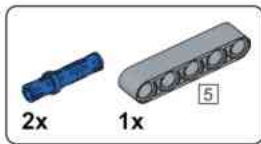
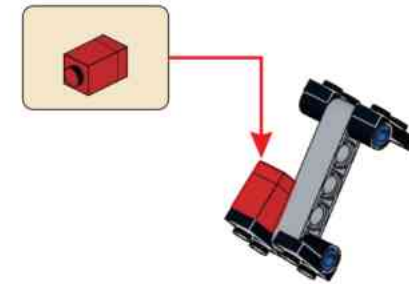

**E6**

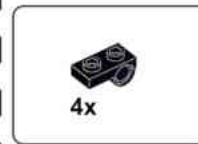

**E7**



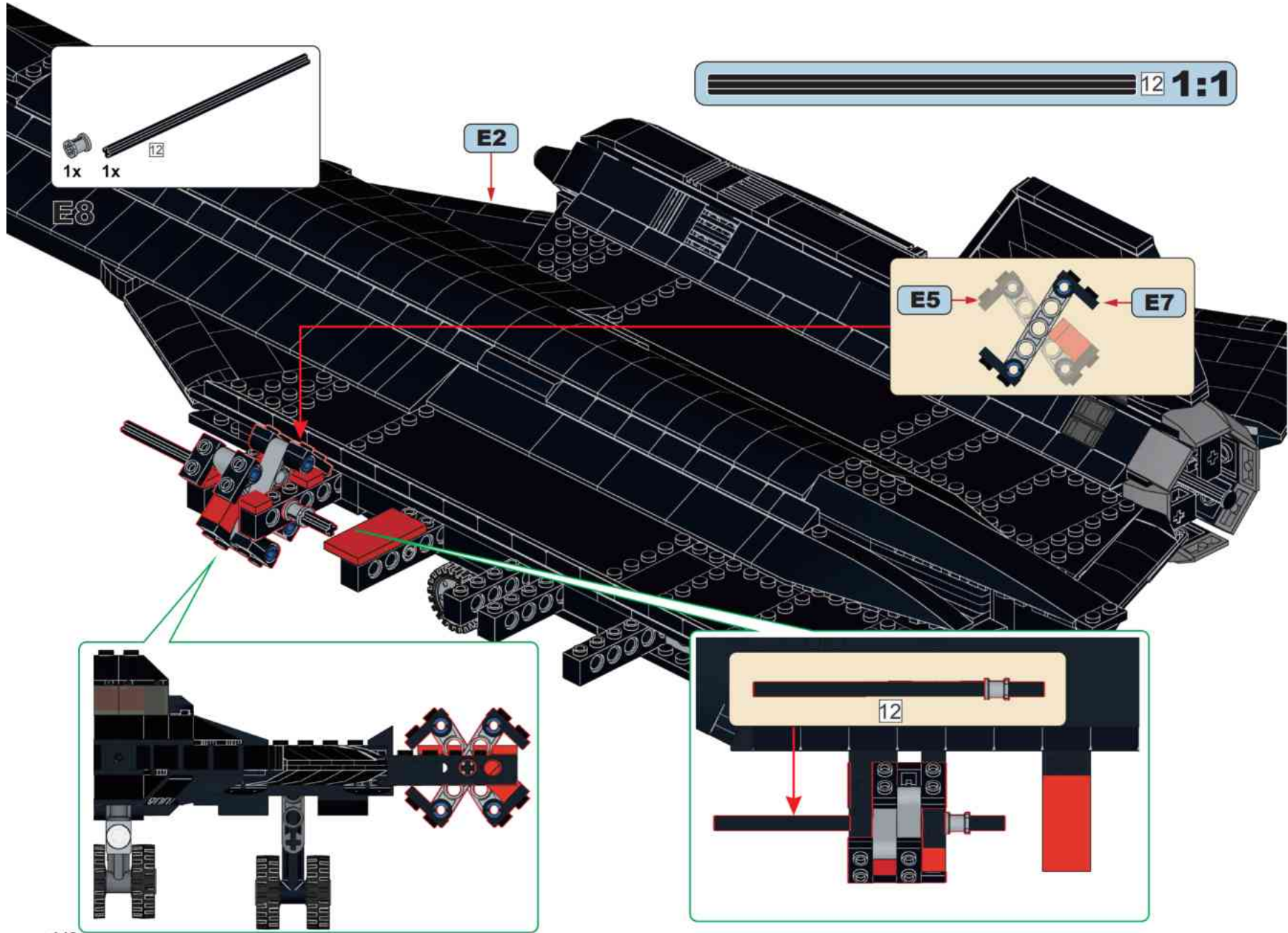

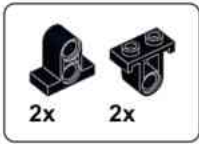

**E9**

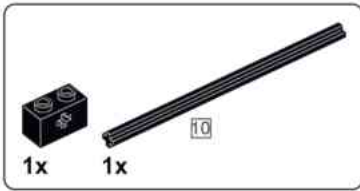
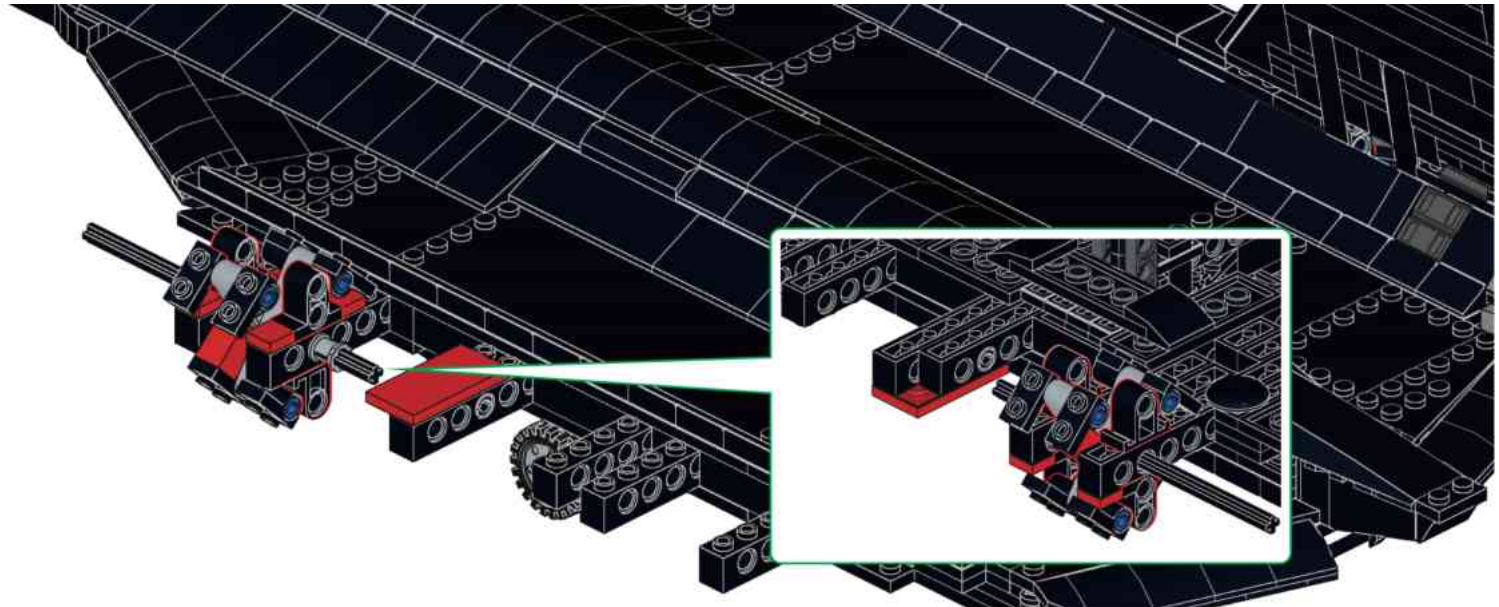

**E10**

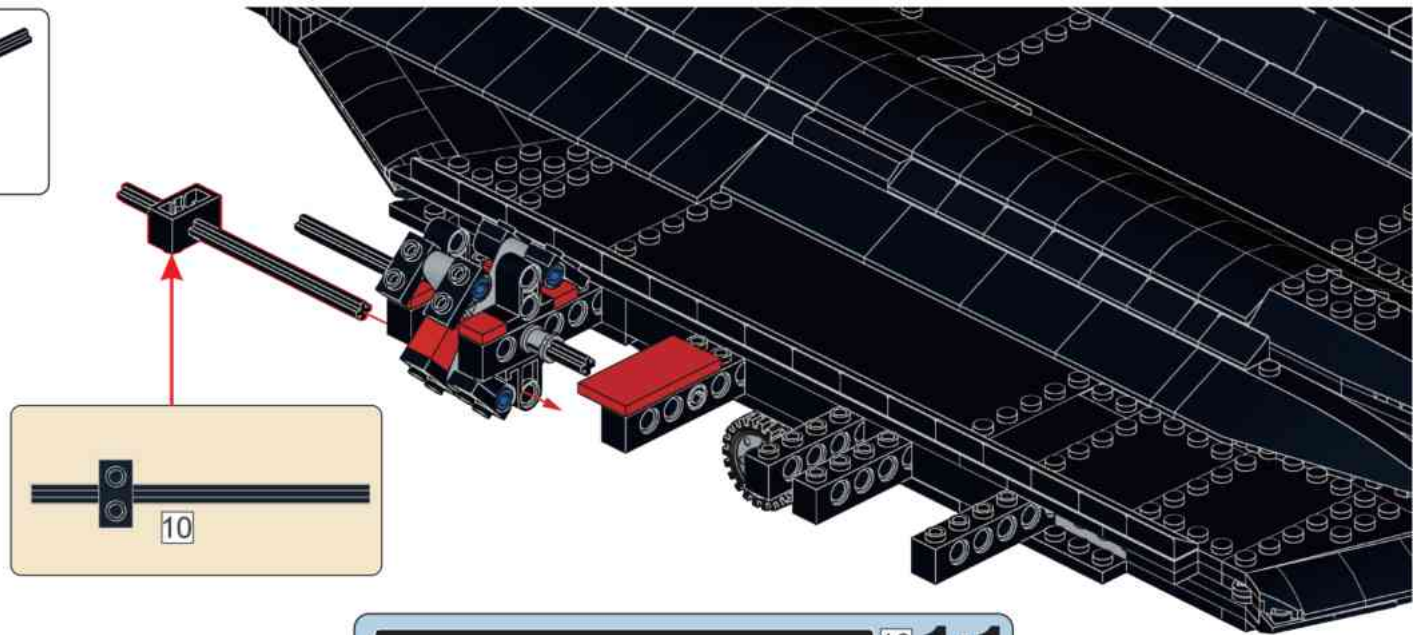

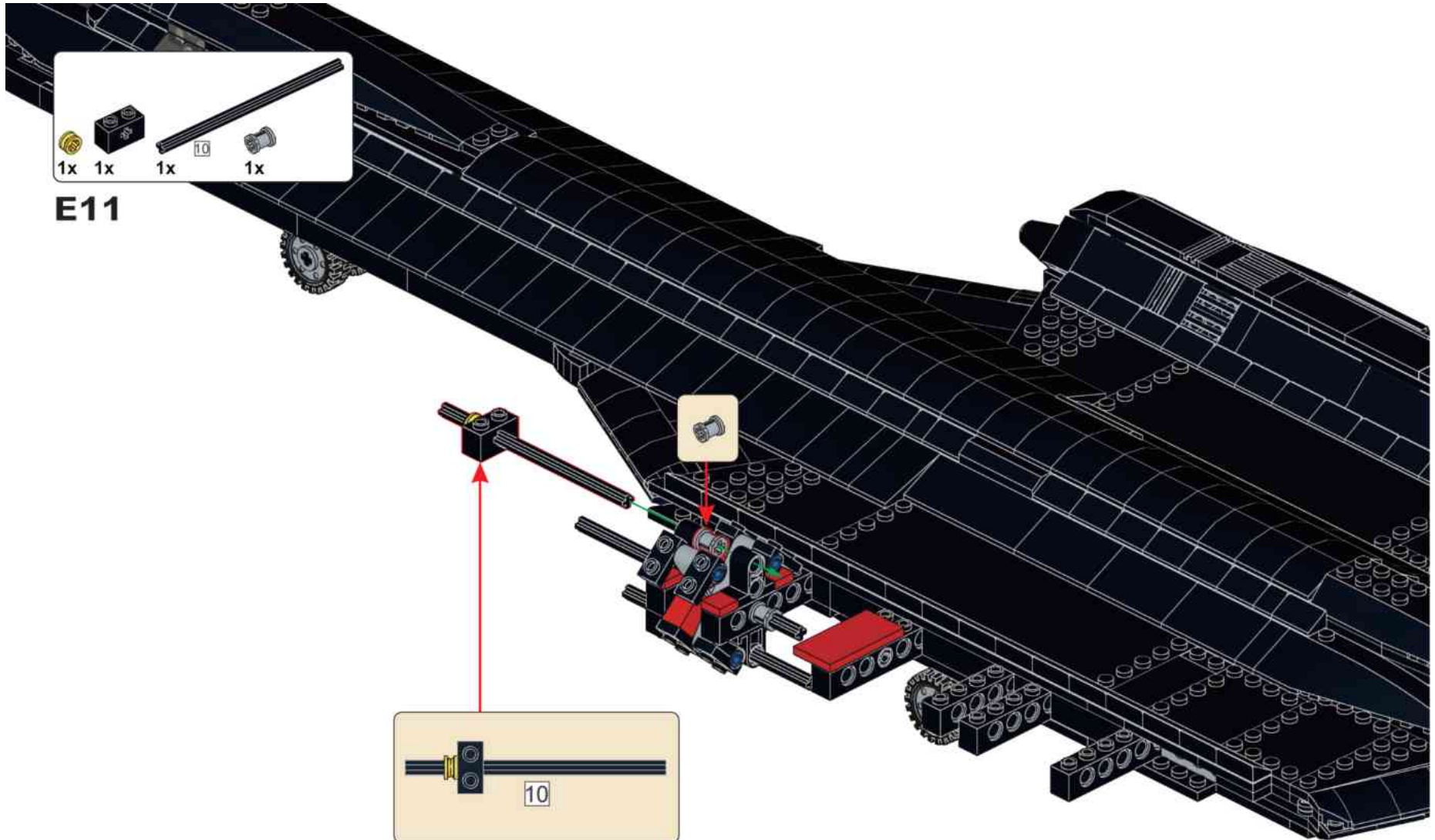

- 1x 1x 1x 10 1x

**E11**

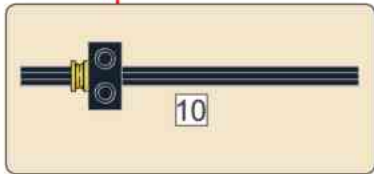

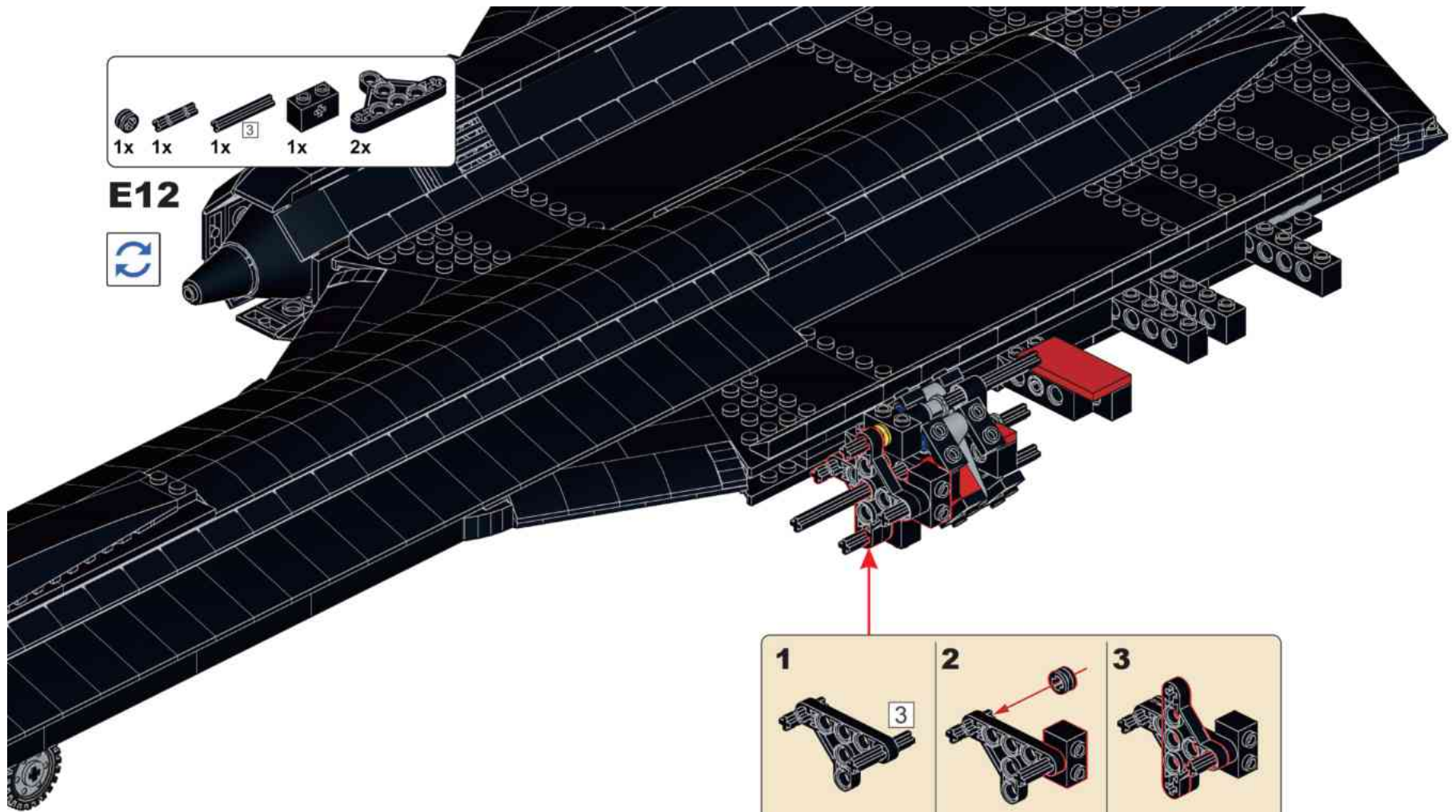

- 1x
- 1x
- 1x
- 1x
- 2x

**E12**

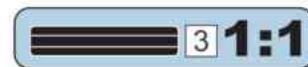
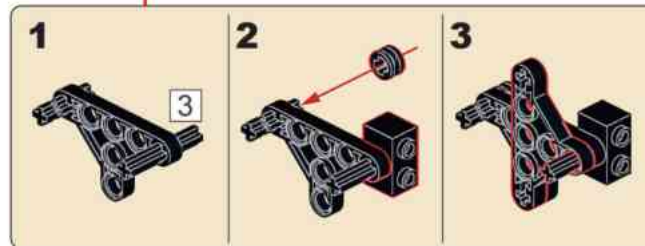

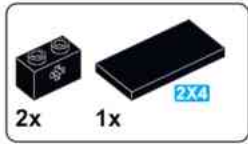

# E13

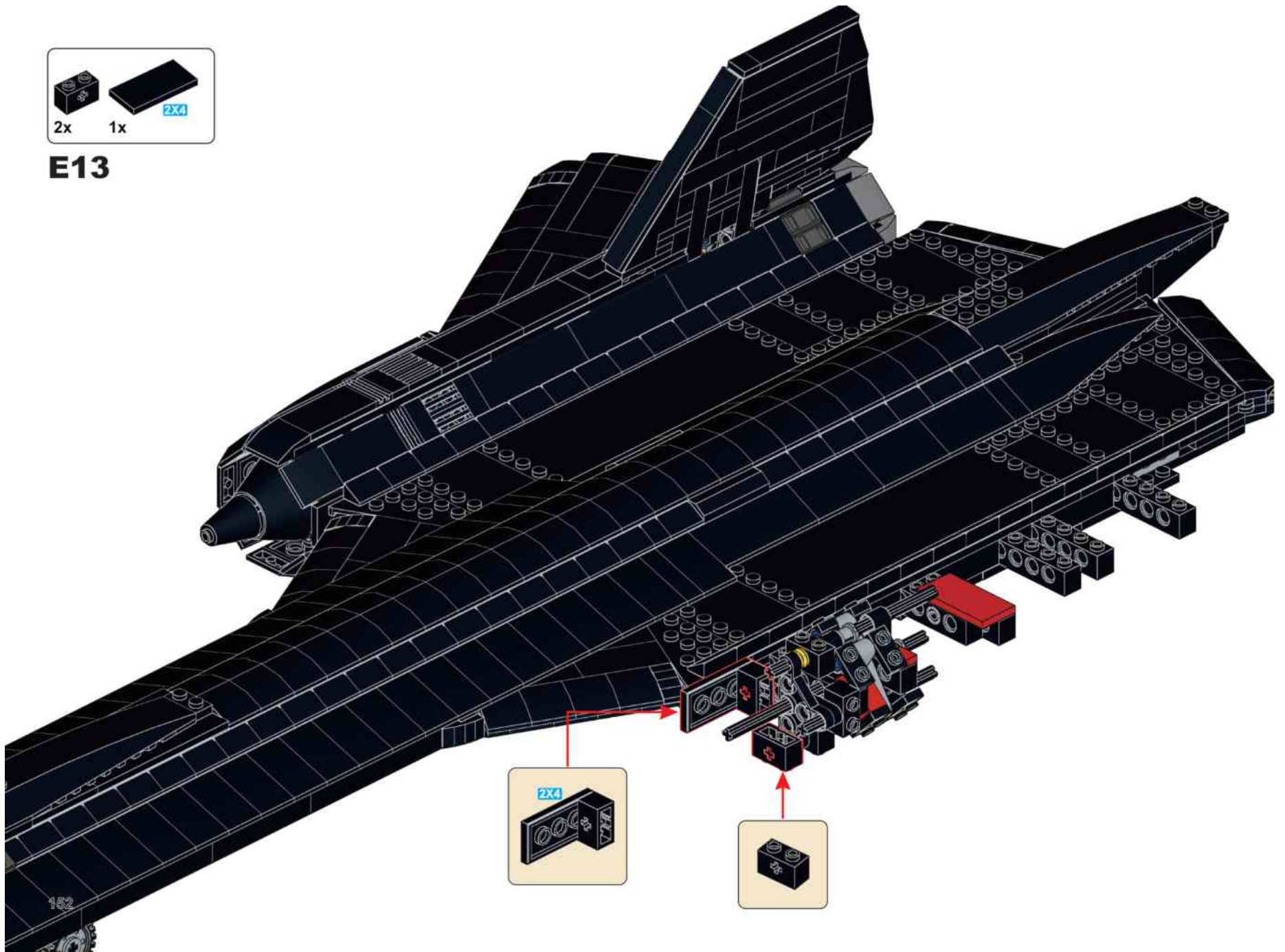

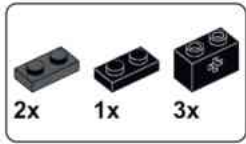

# E14

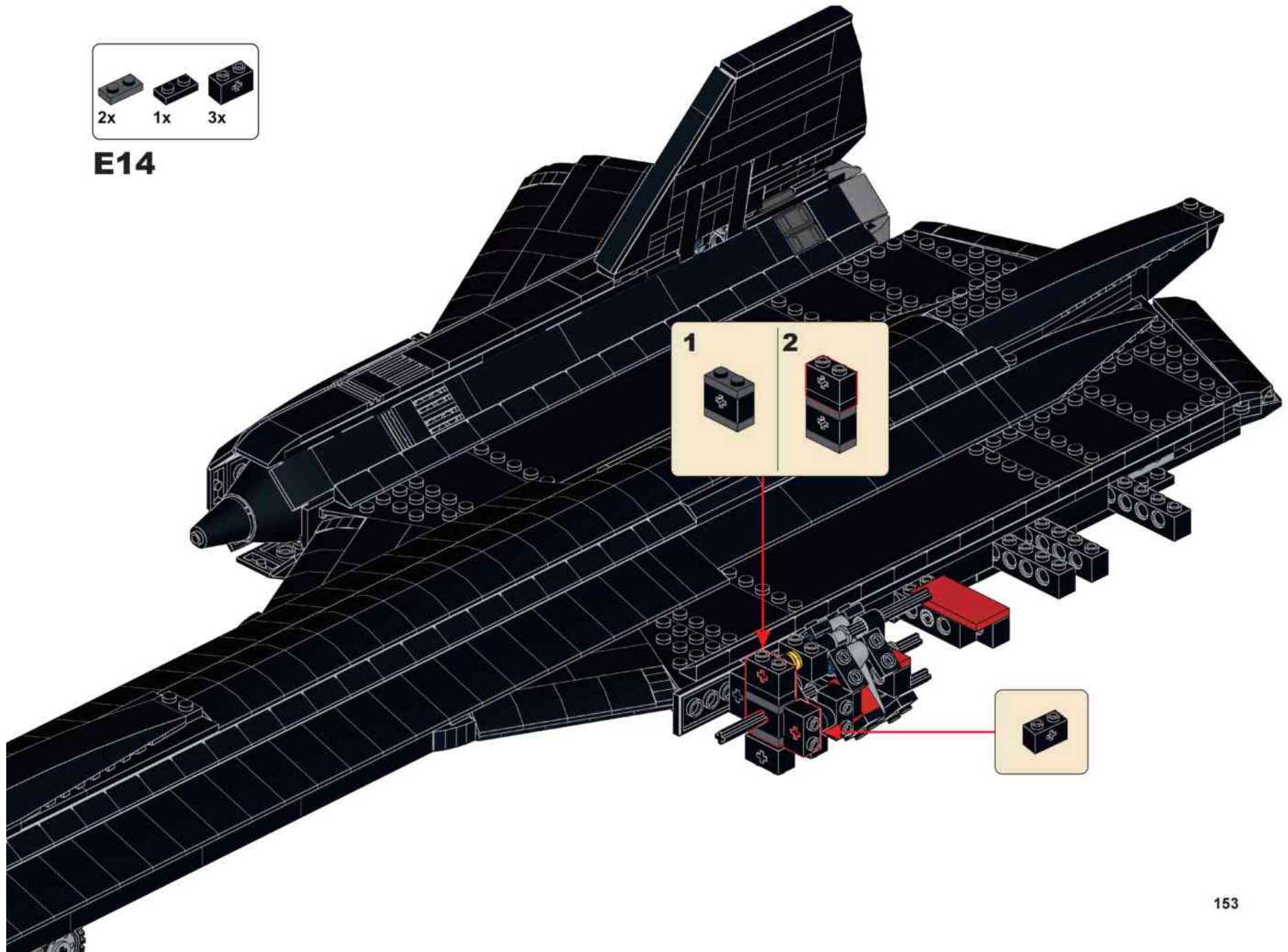

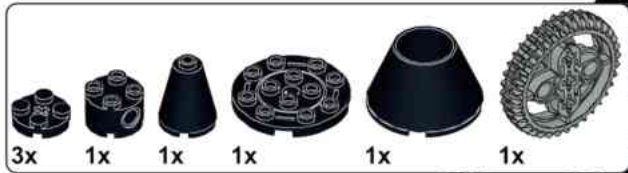

# E15

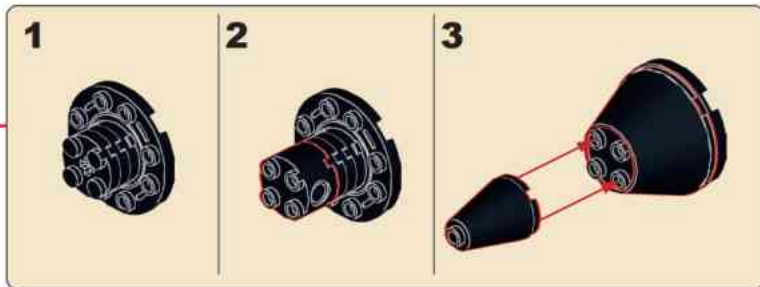
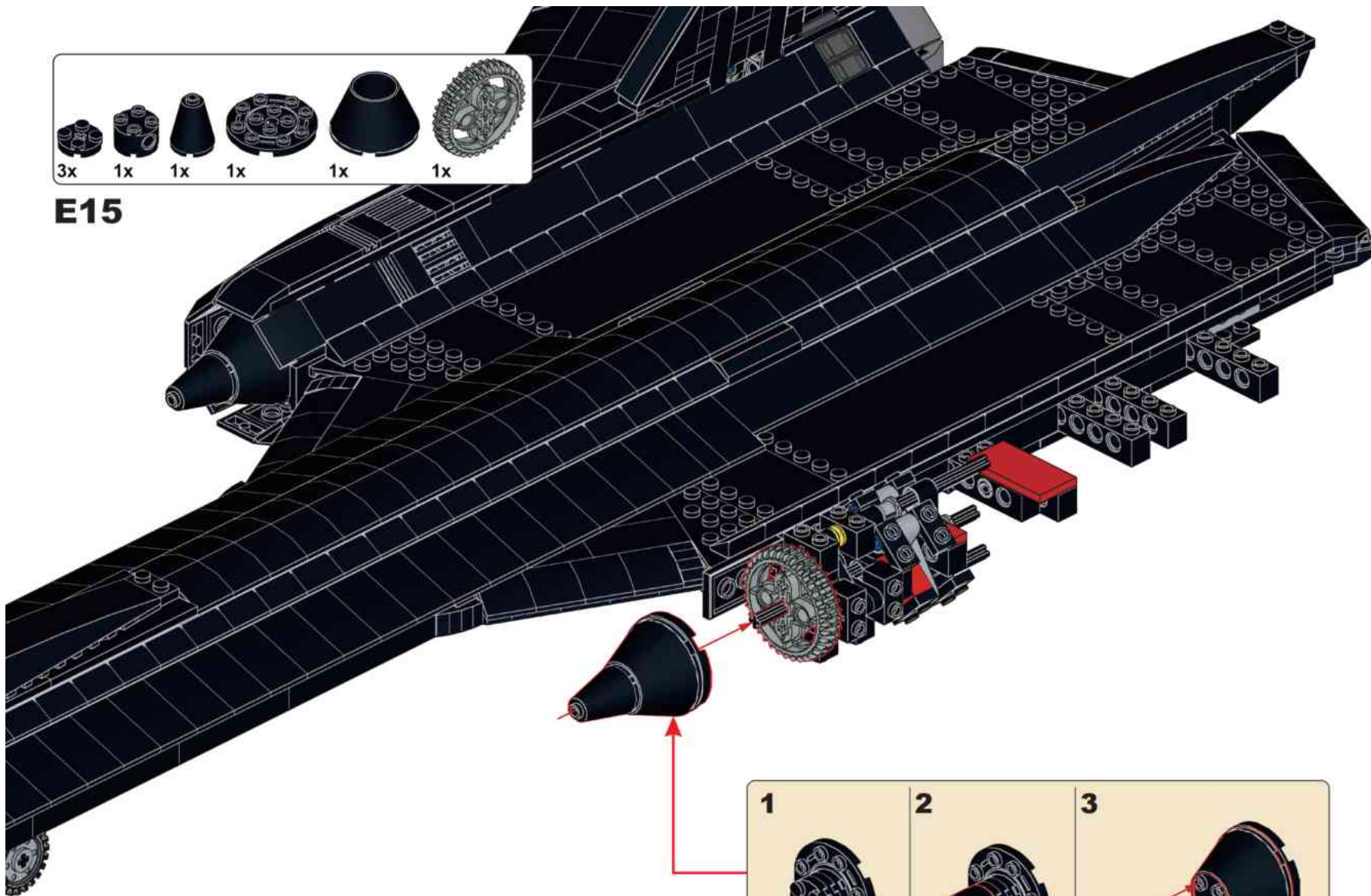

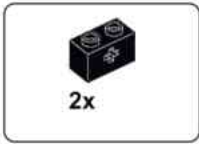

**E16**

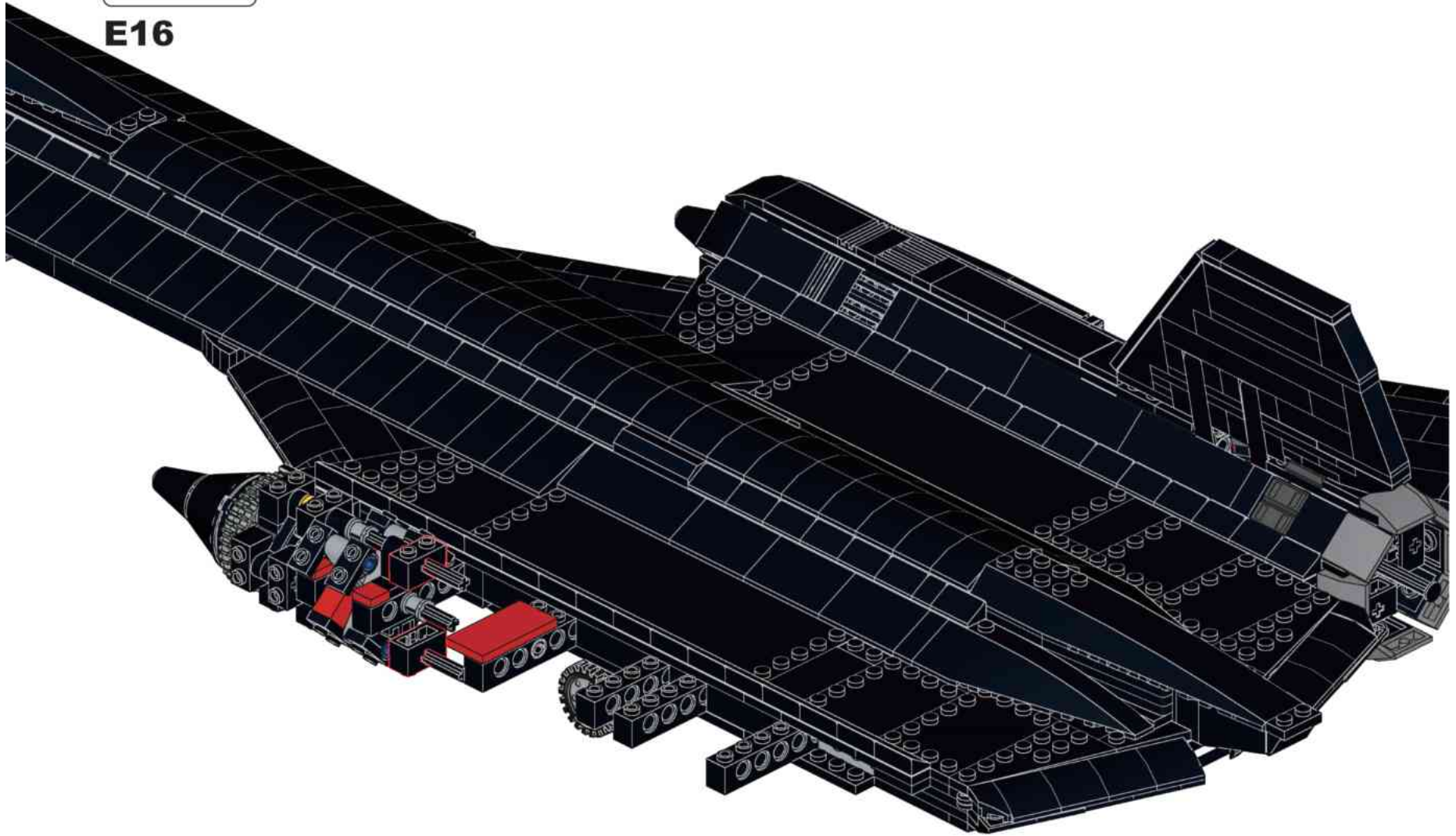

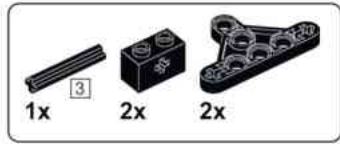

**E17**

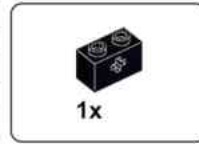
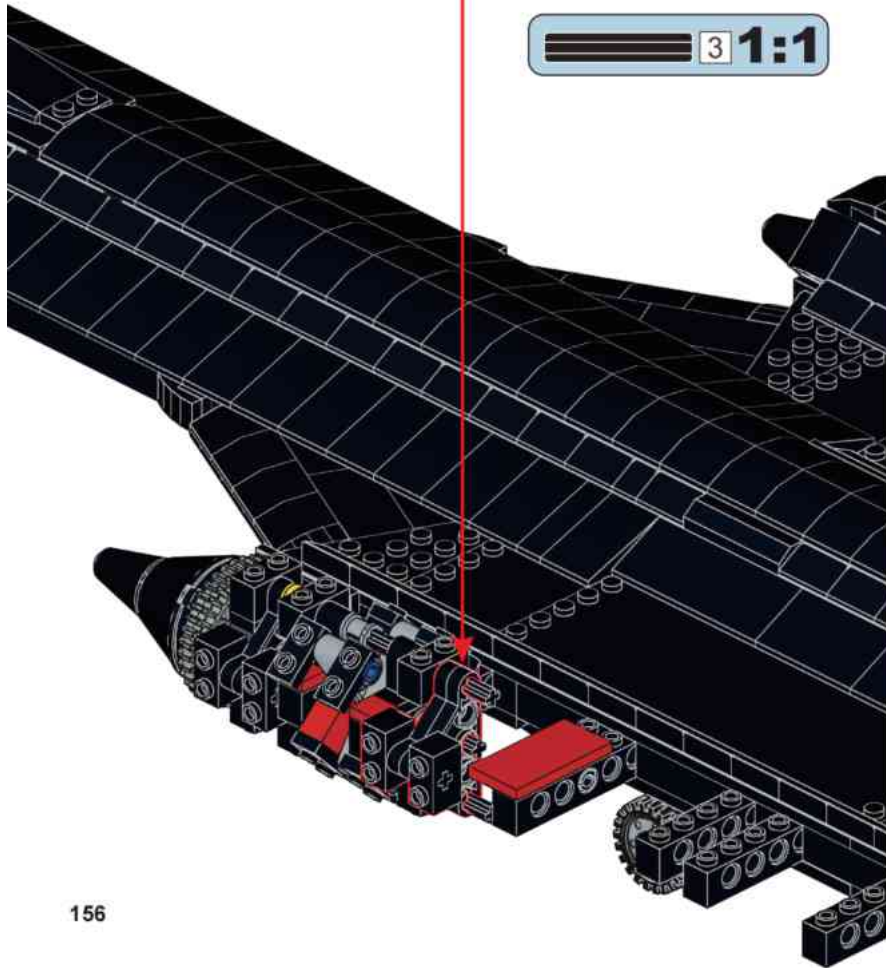
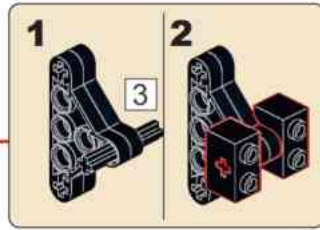

**E18**

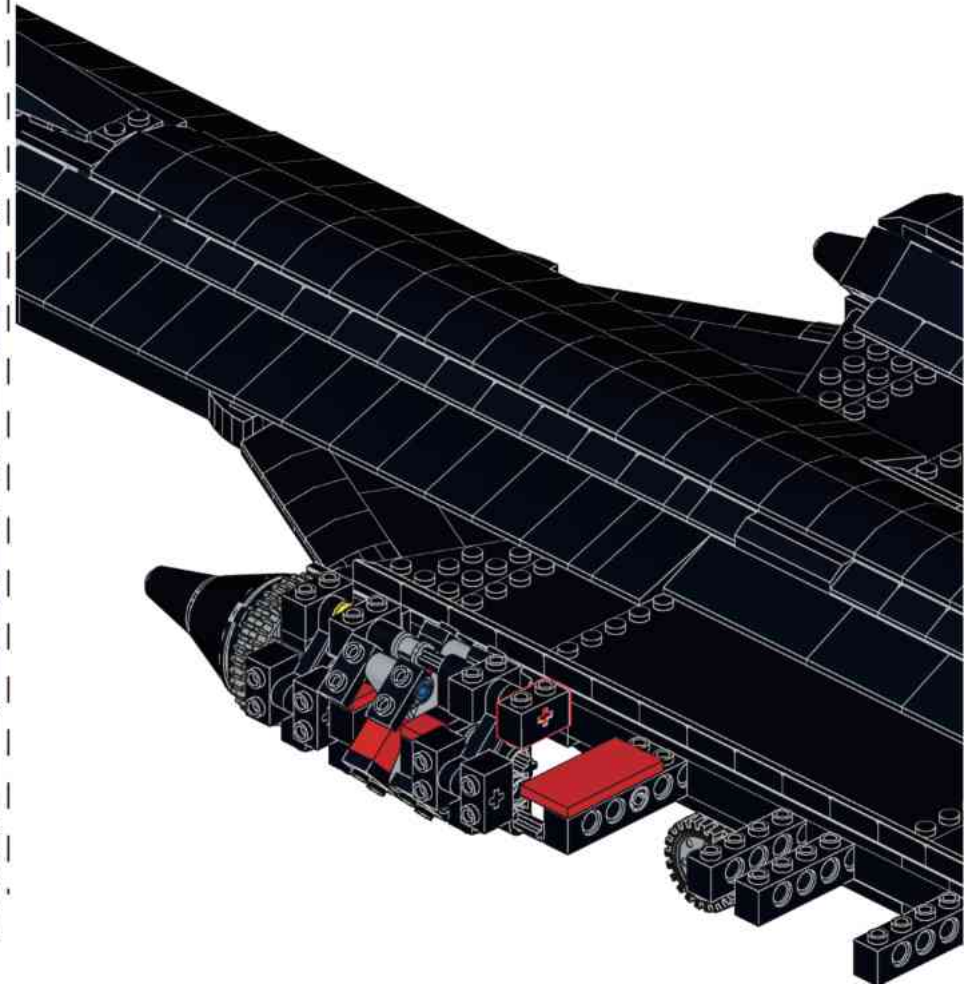

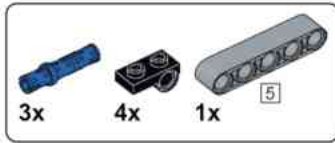

**E19**

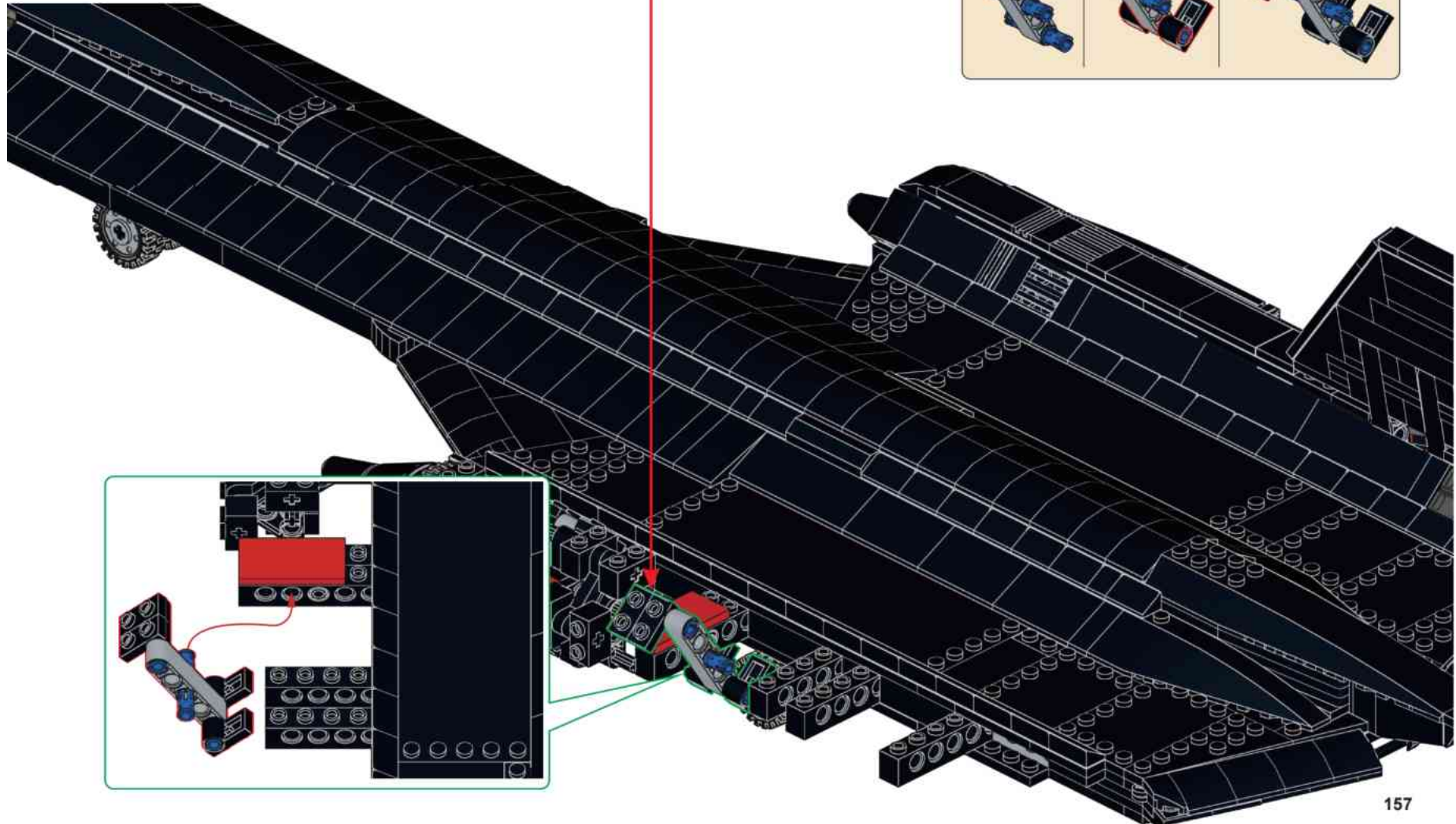
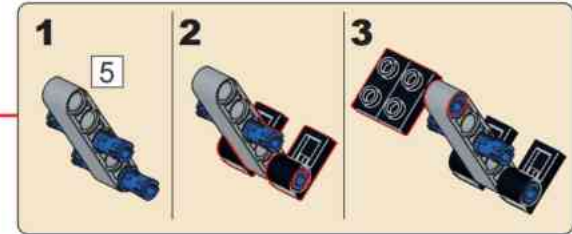

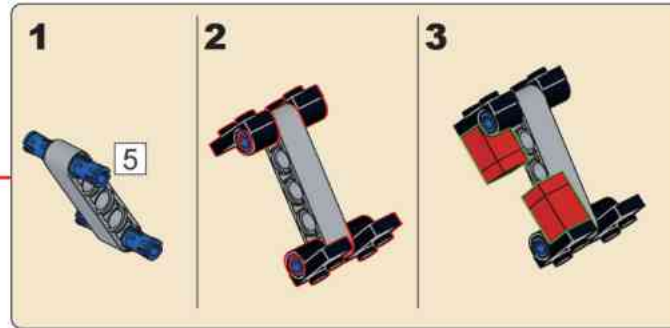
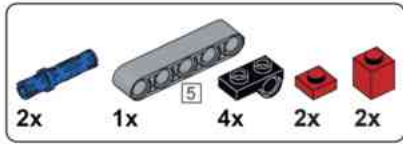

E20

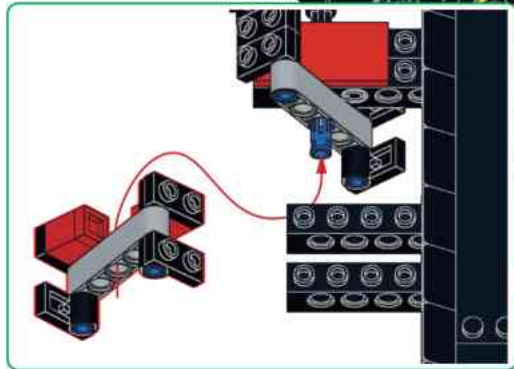

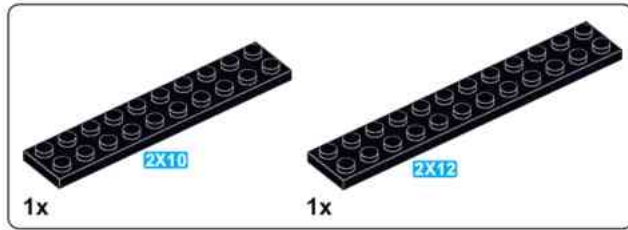

**E21**

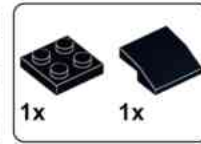

**E22**

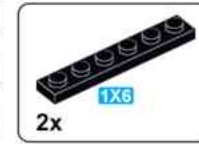

**E23**

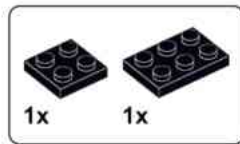
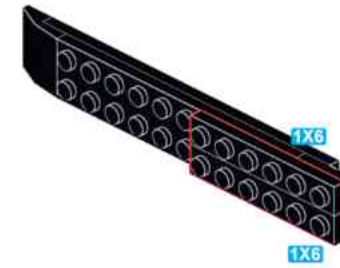

**E24**

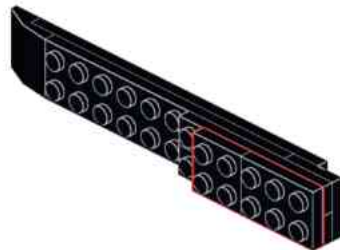

**E25**

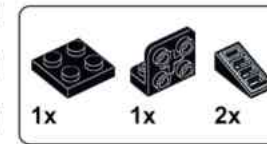
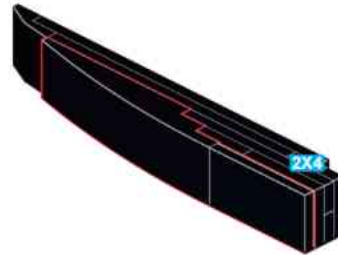

**E26**

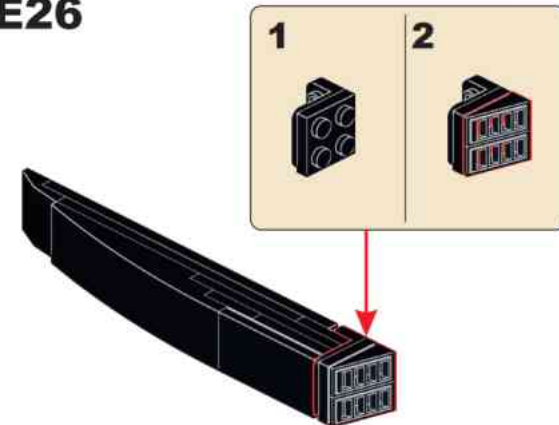

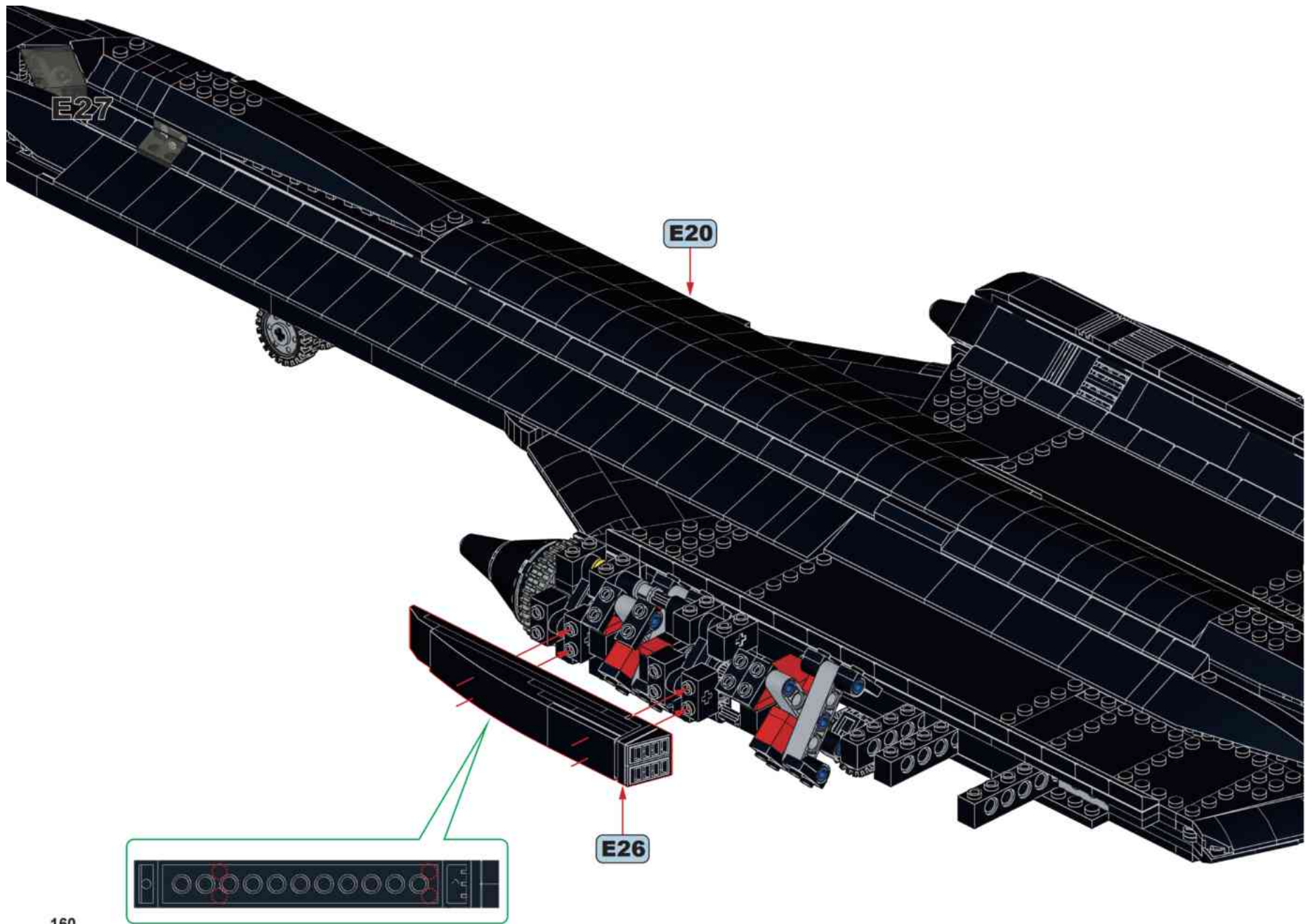

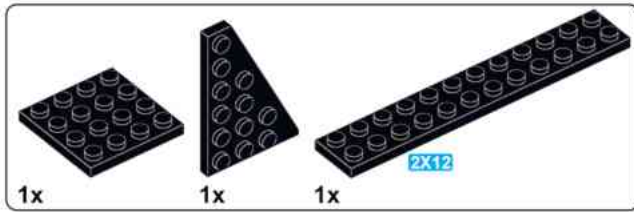

**E28**

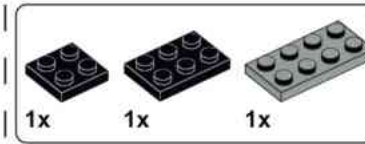
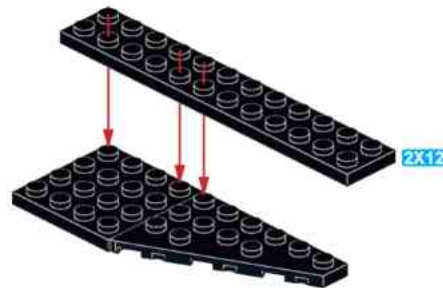

**E29**

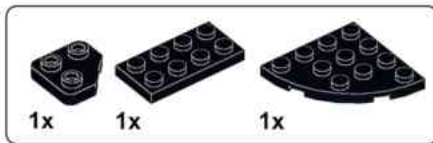
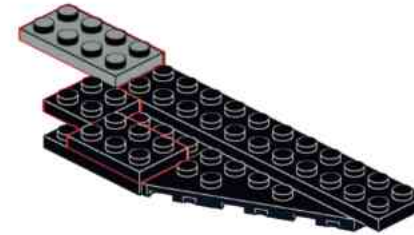

**E30**

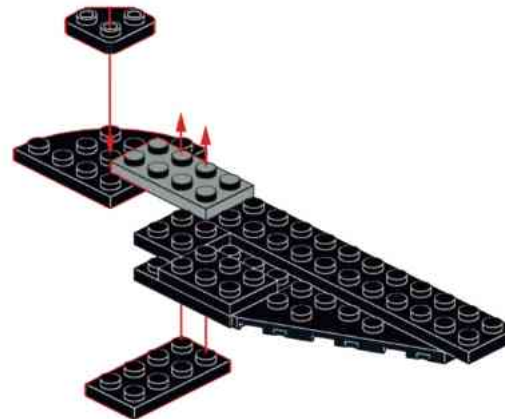

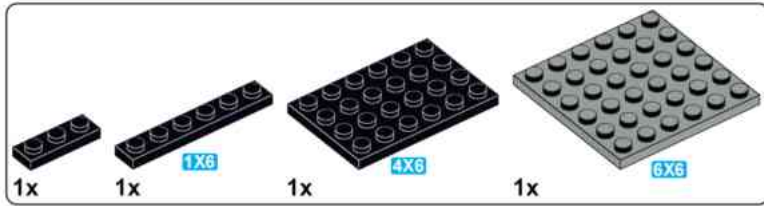

### E31

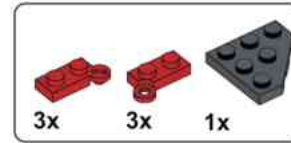
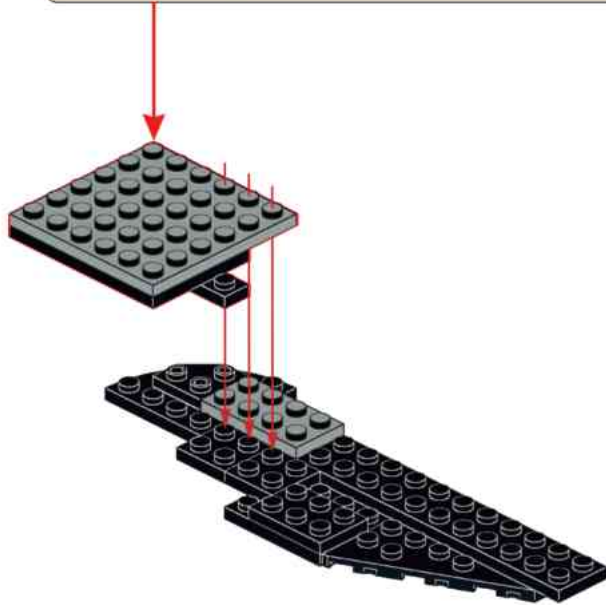
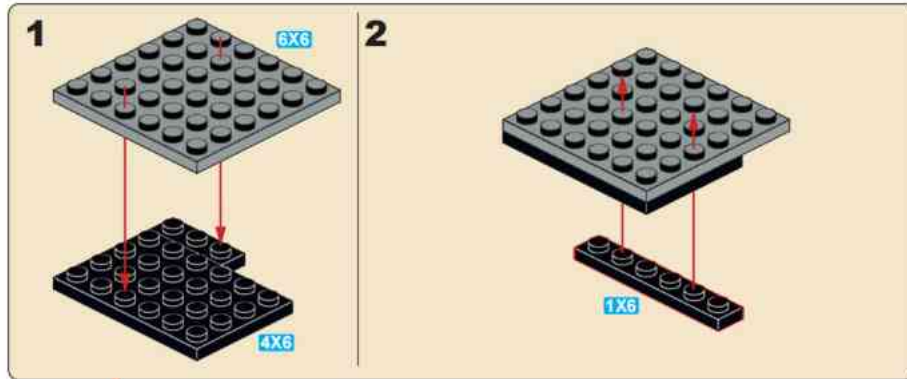

### E32

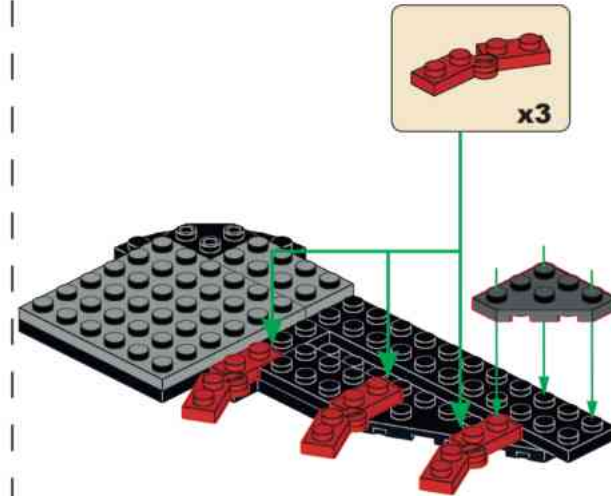

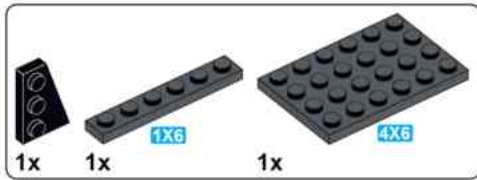

**E33**

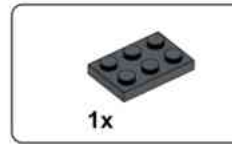
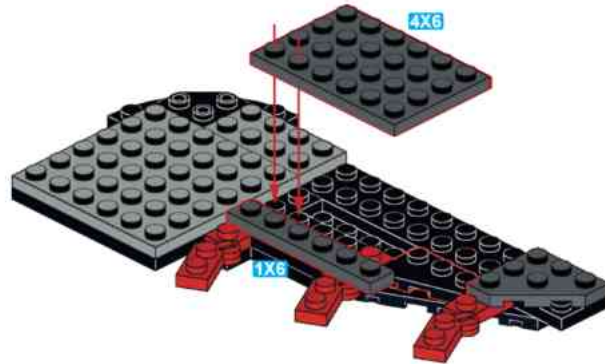

**E34**

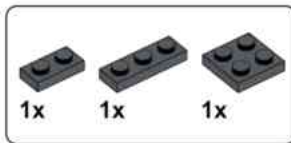
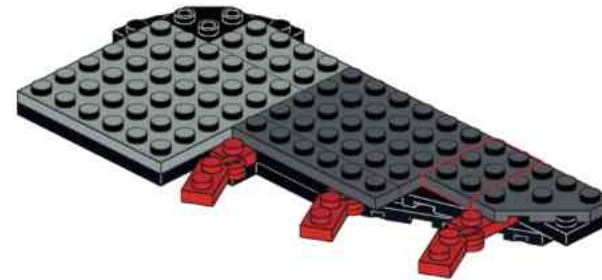

**E35**

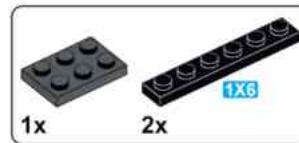
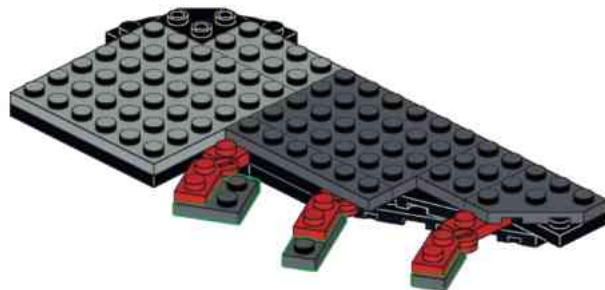

**E36**

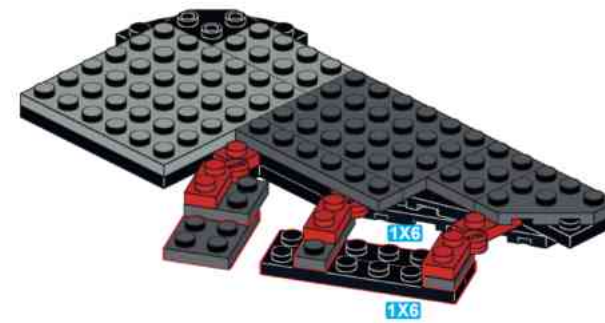



### E37

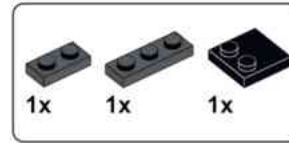
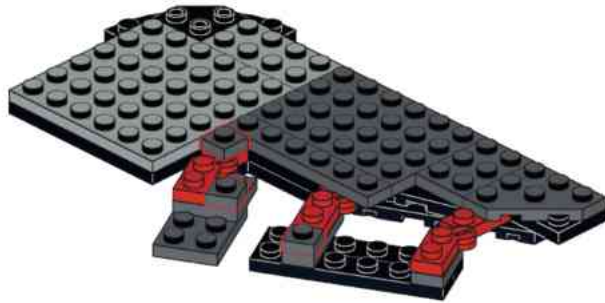

### E38

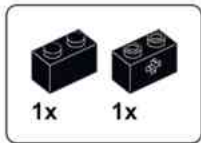
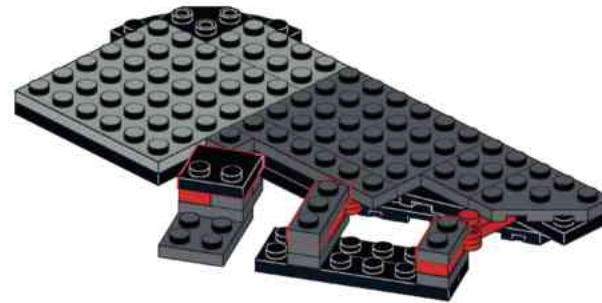

### E39

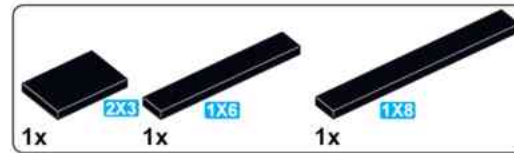
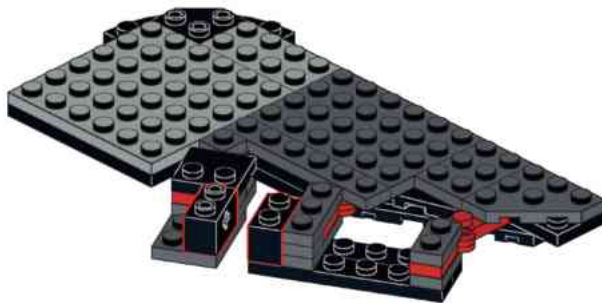

### E40

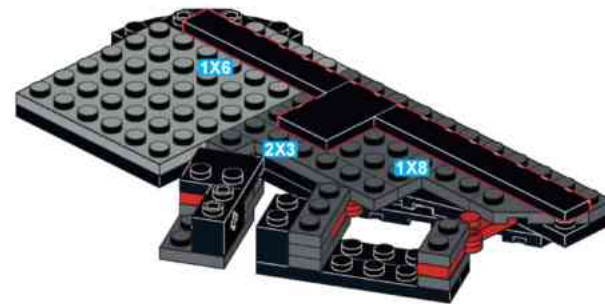



**E41**

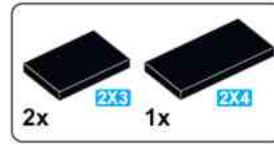
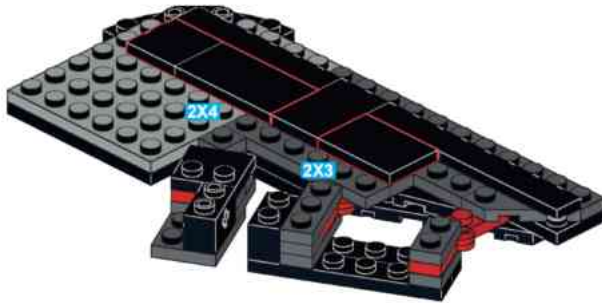

**E42**

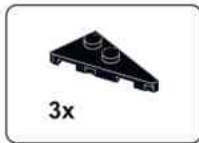
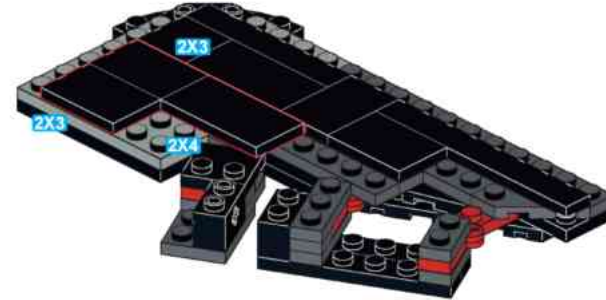

**E43**

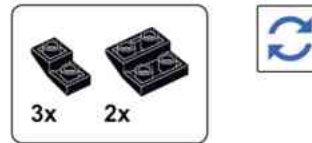

**E44**





**E45**

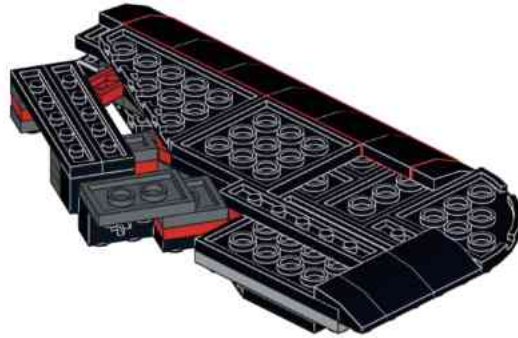

**E46**

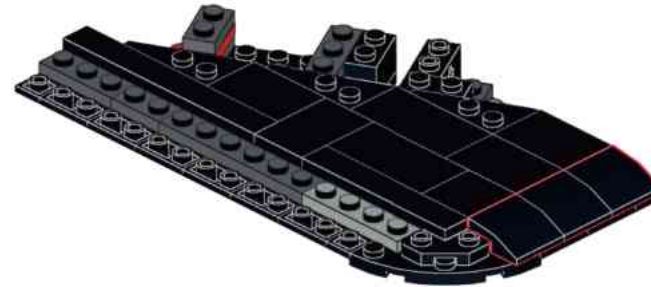

**E47**

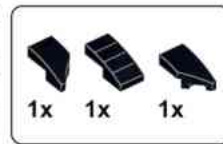

**E48**



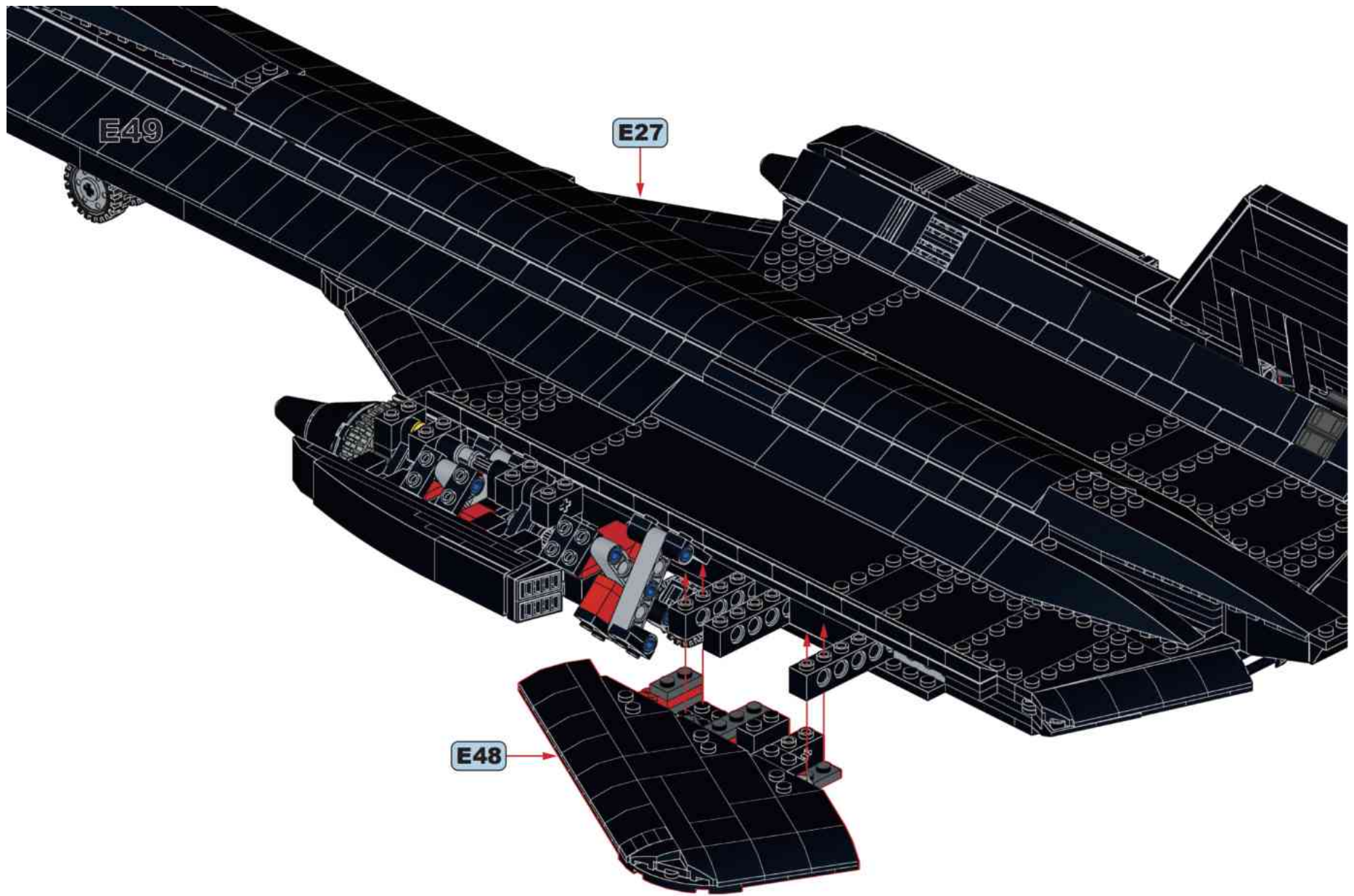

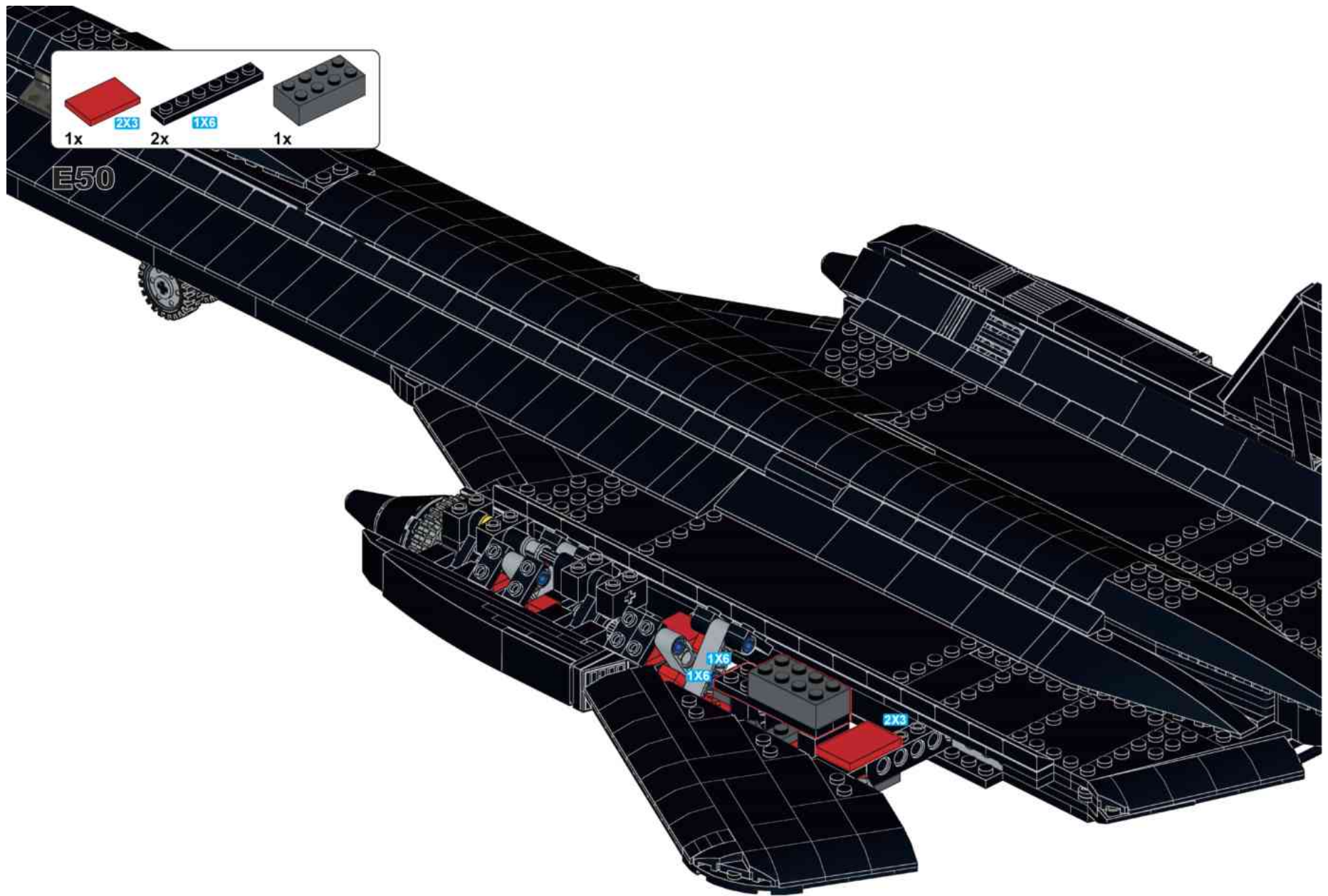

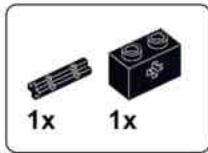

**E51**



**E52**

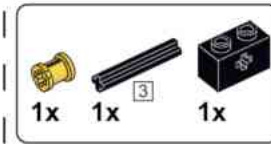

**E53**

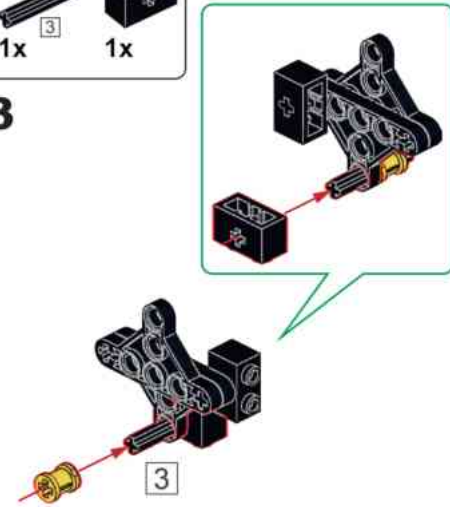

**E54**

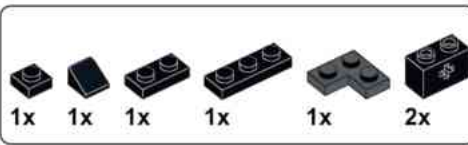

**E55**

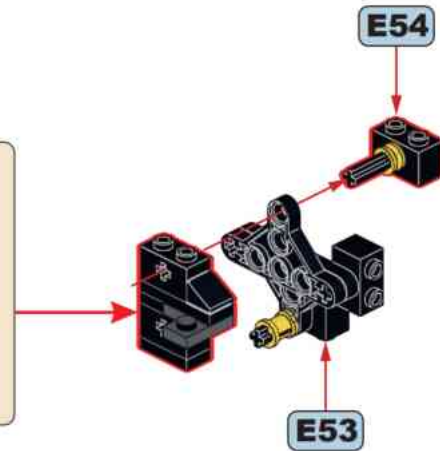
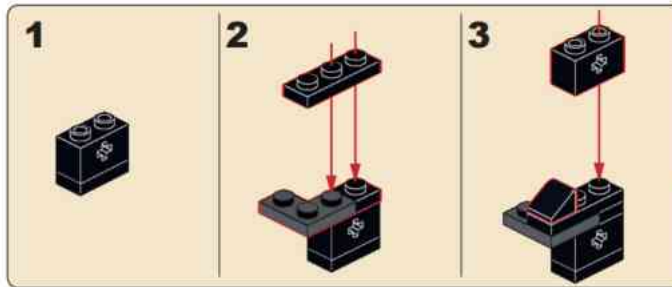

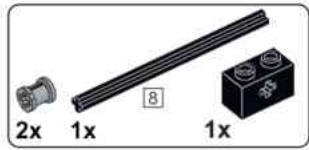

**E56**

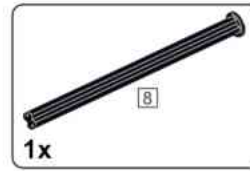
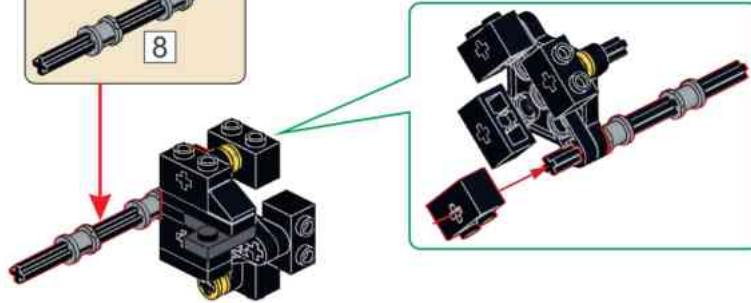
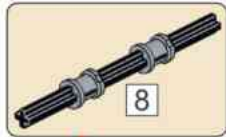

**E57**

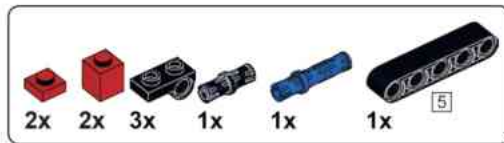
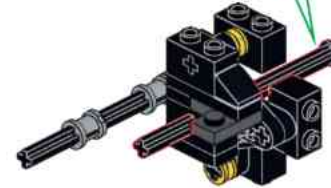
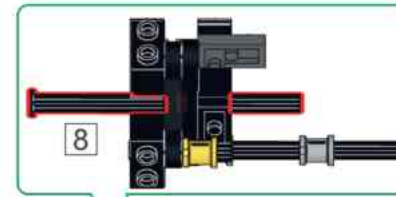

**E58**

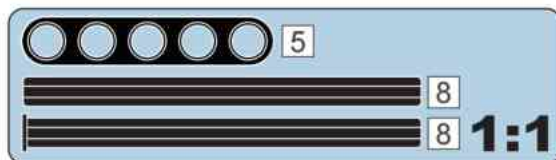
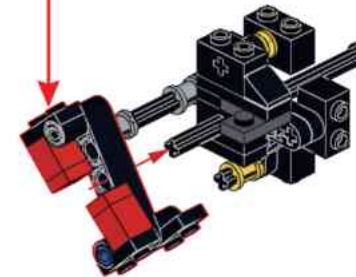
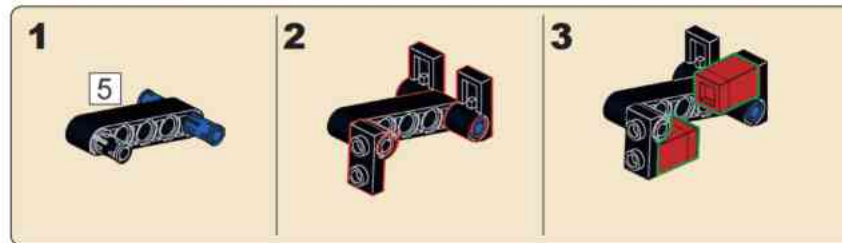

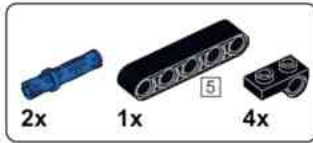

### E59

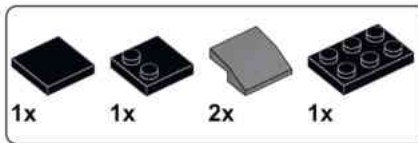
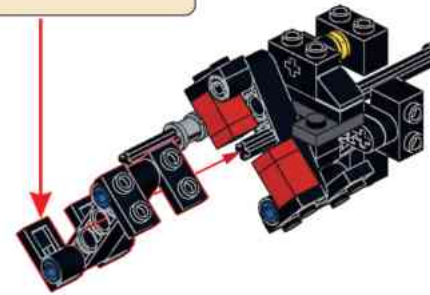
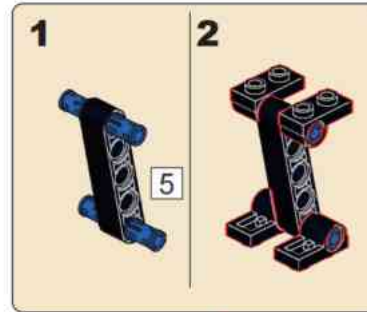

### E60

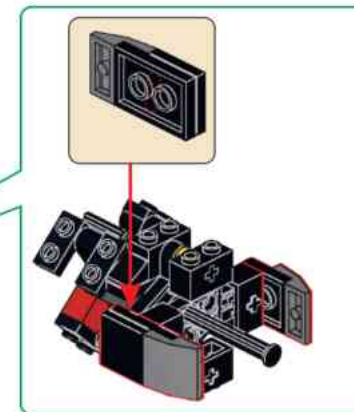
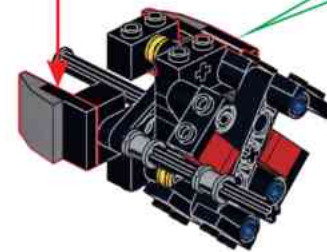

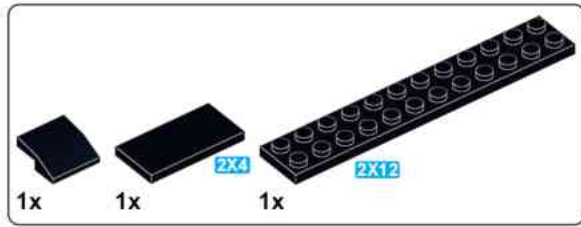

**E61**

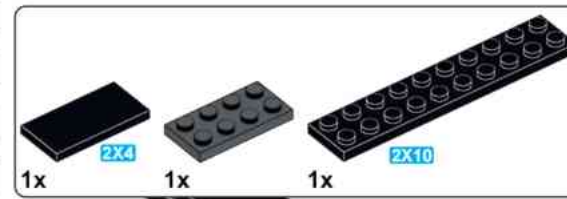
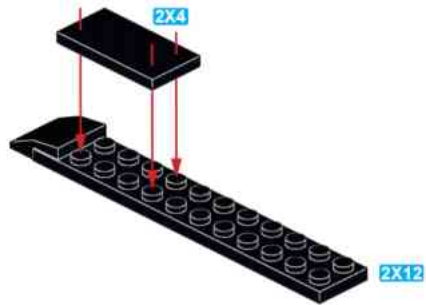

**E62**

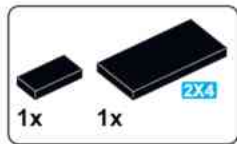
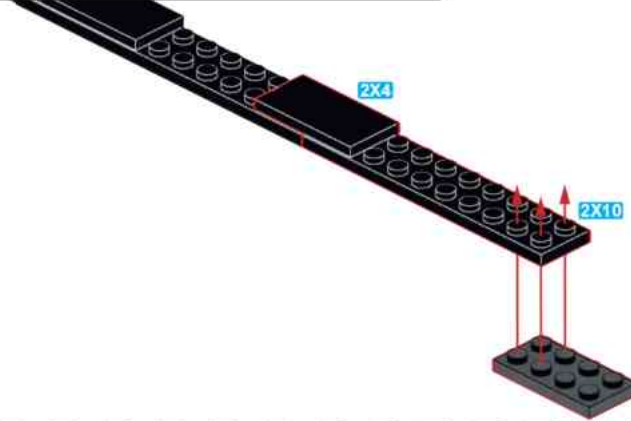

**E63**

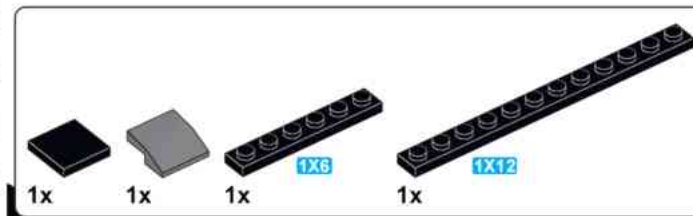

**E64**



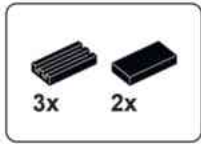

**E65**

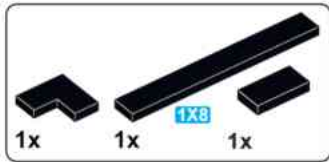

**E66**

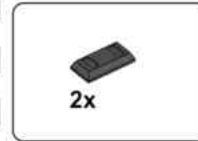

**E67**



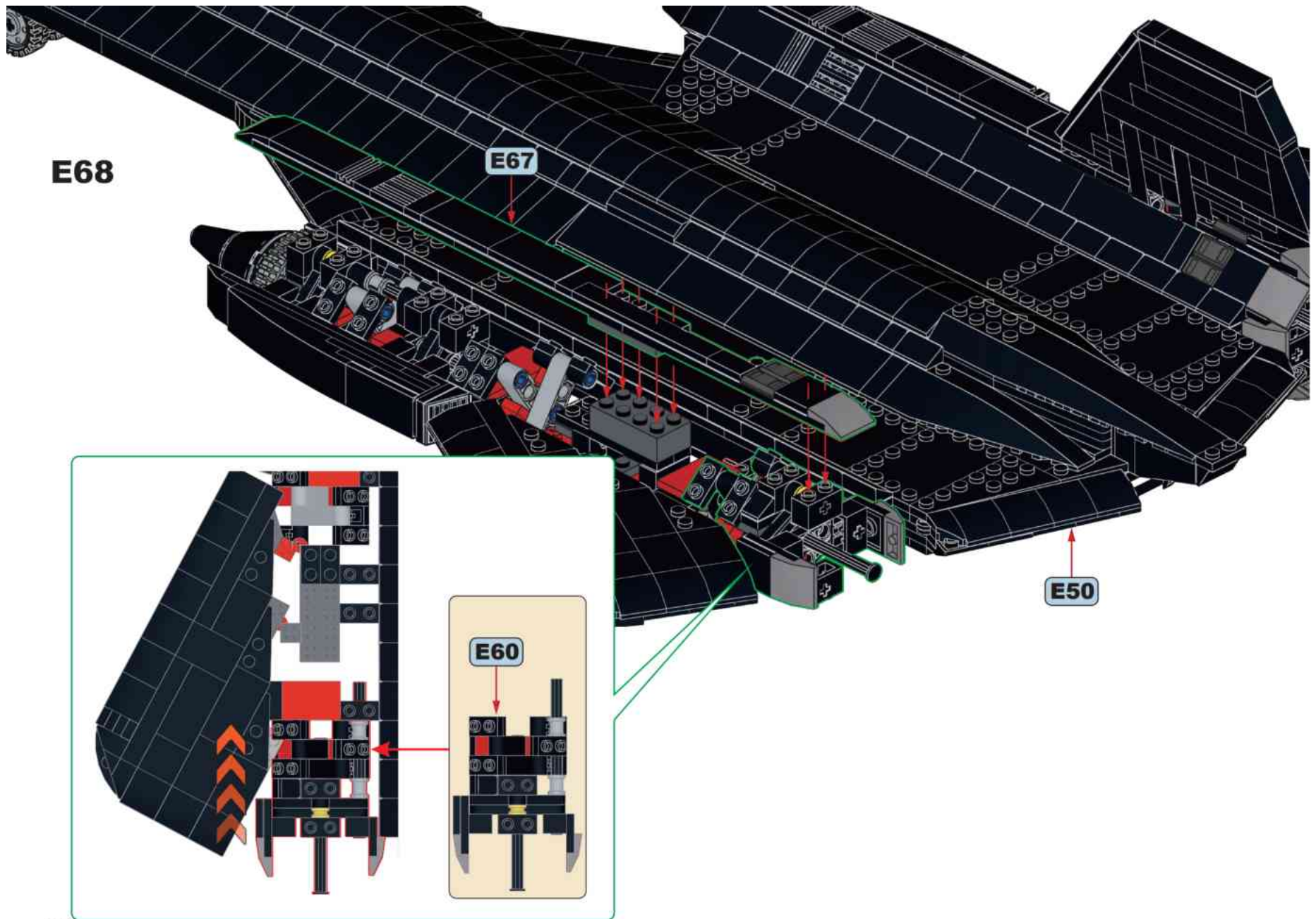

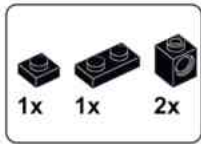

**E69**

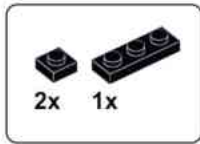

**E70**

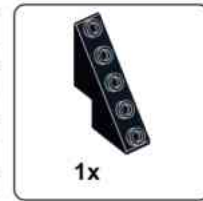
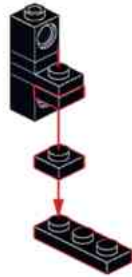

**E71**

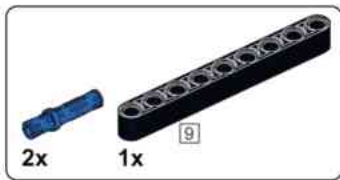

**E72**

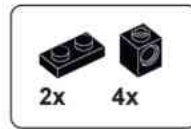
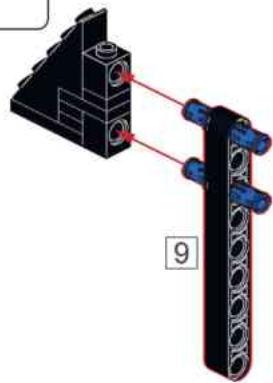

**E73**

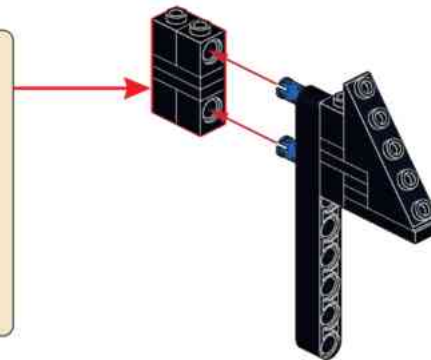
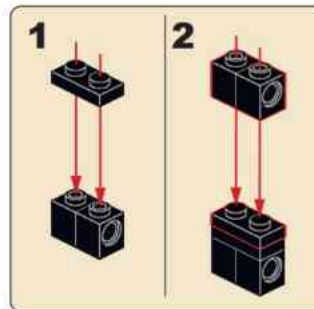

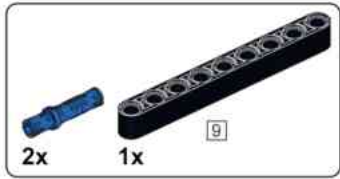

**E74**

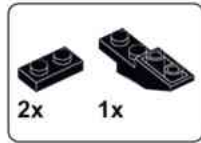
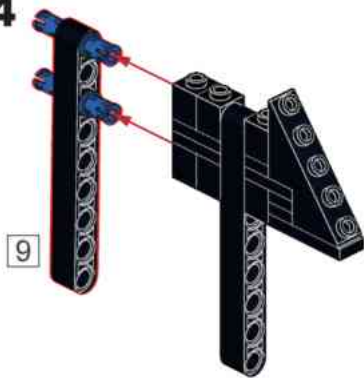

**E75**

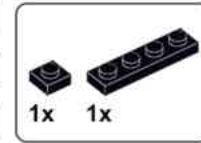

**E76**

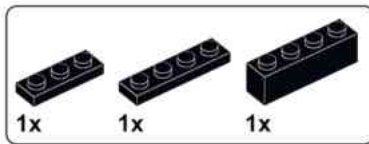

**E77**

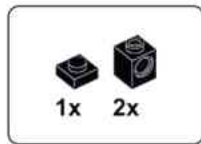
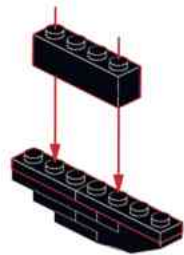

**E78**

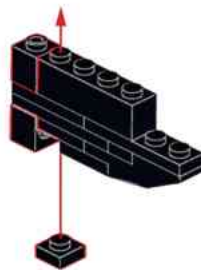

**E79**

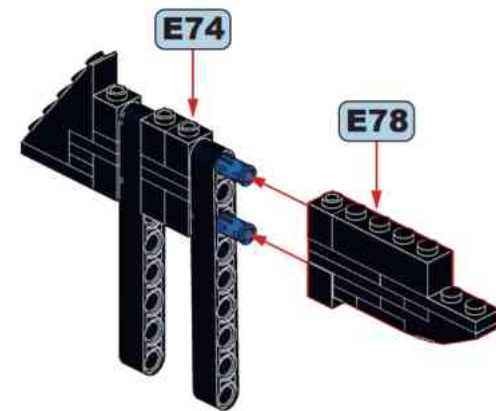

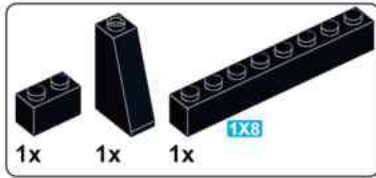

**E80**

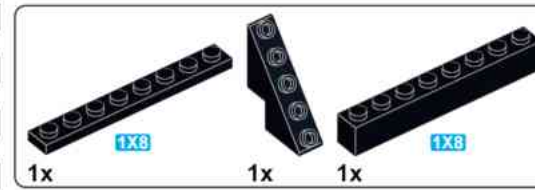
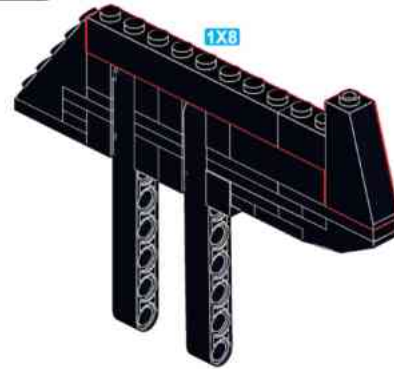

**E81**

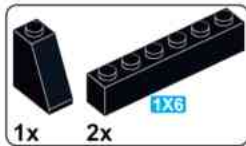
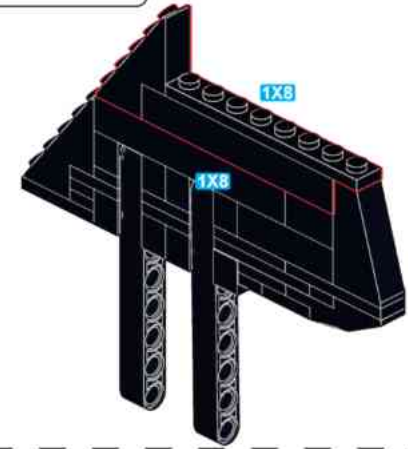

**E82**

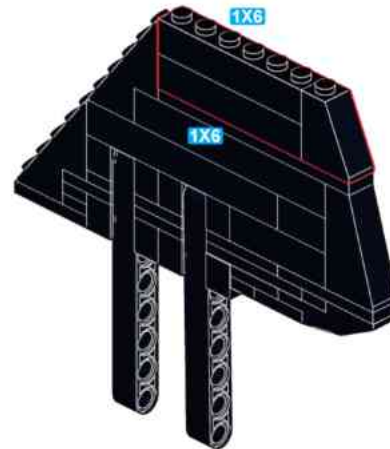

**E83**

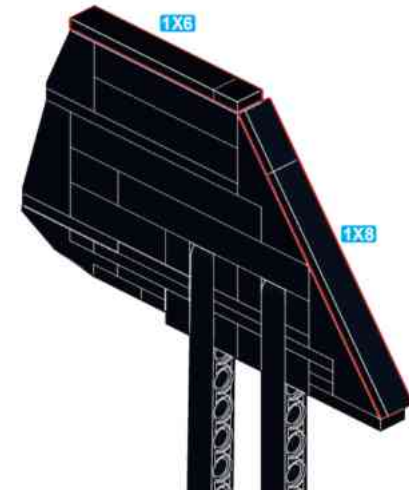

**E84**

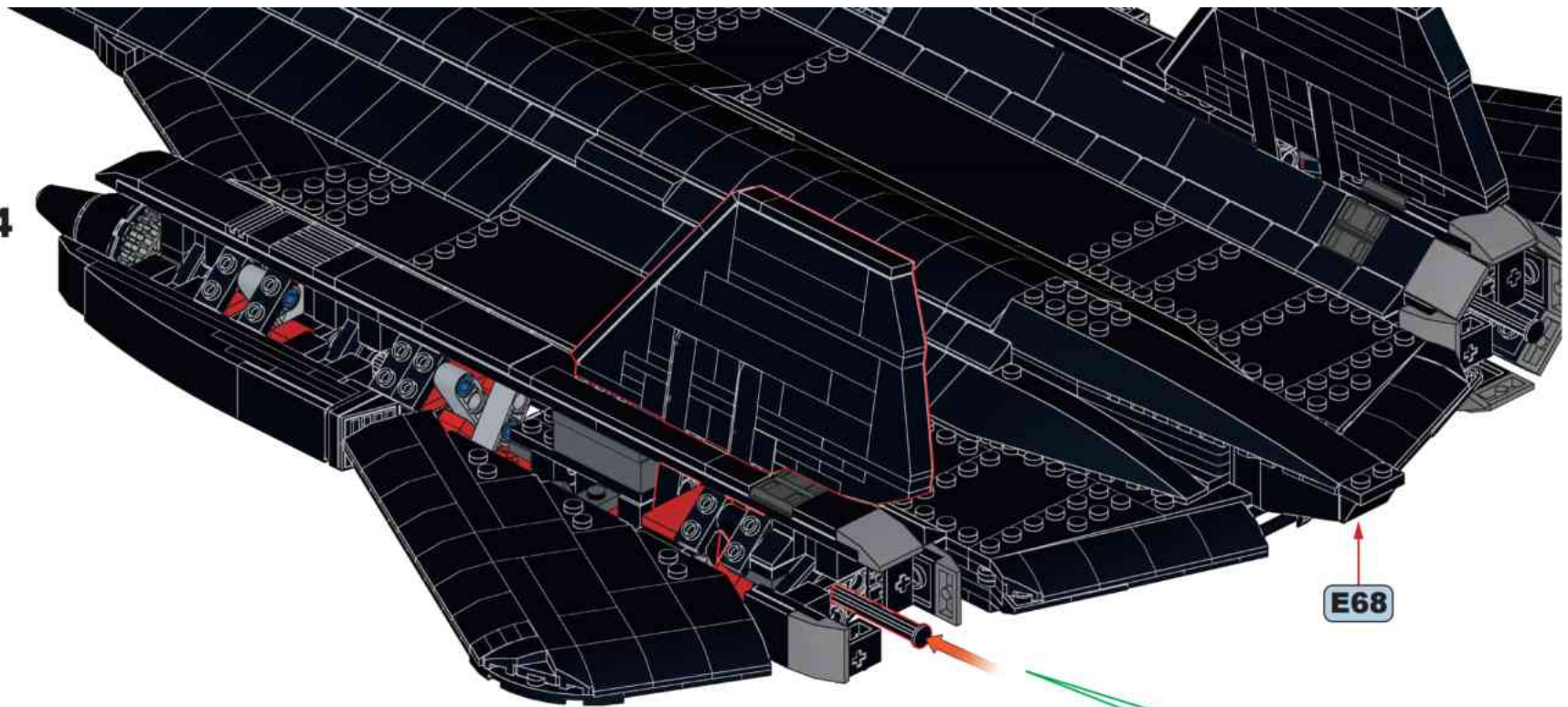

**E68**

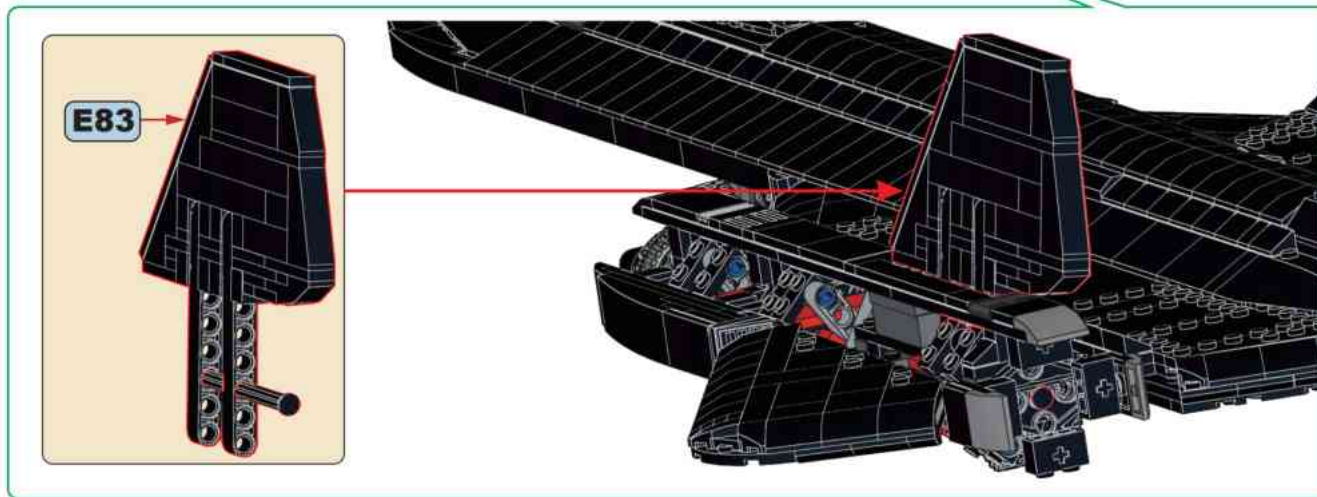

**E83**

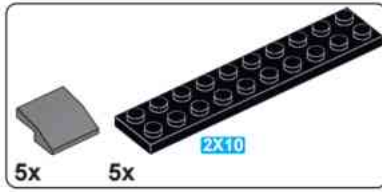

**E85**



**x5**

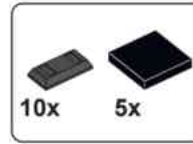

**E86**



**x5**

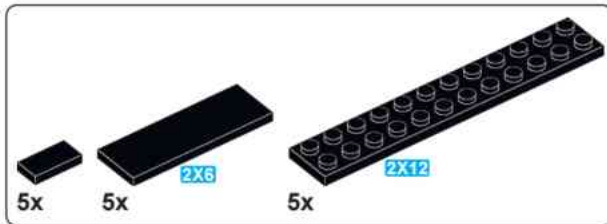

**E87**

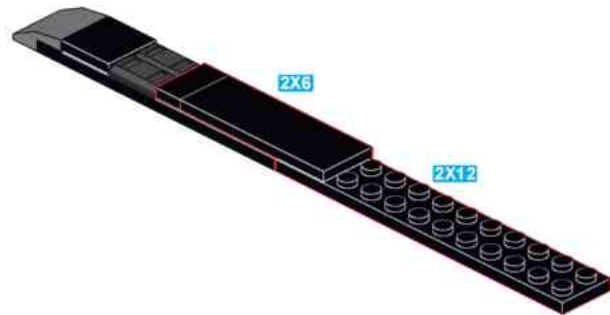

**x5**



**E88**



**x5**

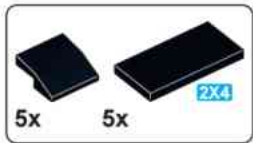
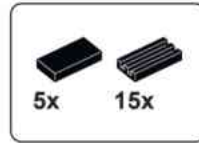
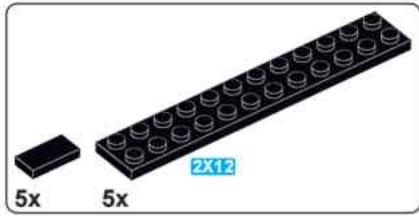

**E91**



**E92**

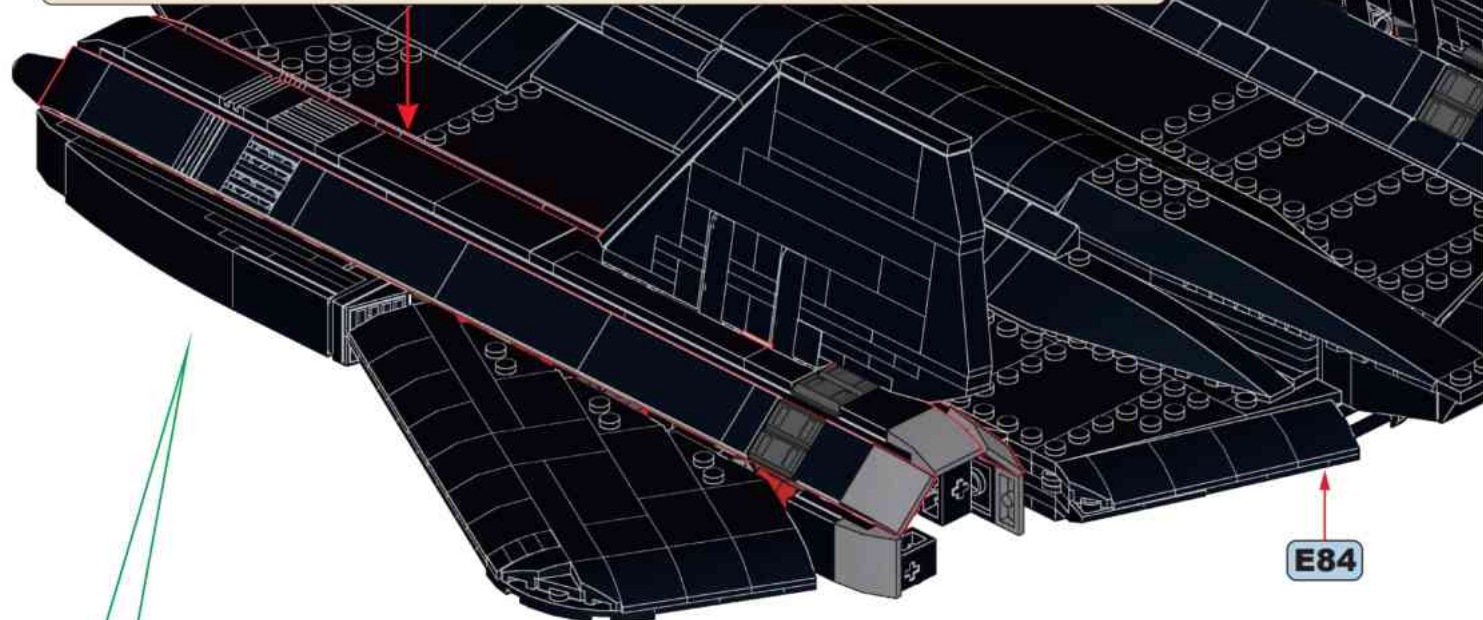

**E84**

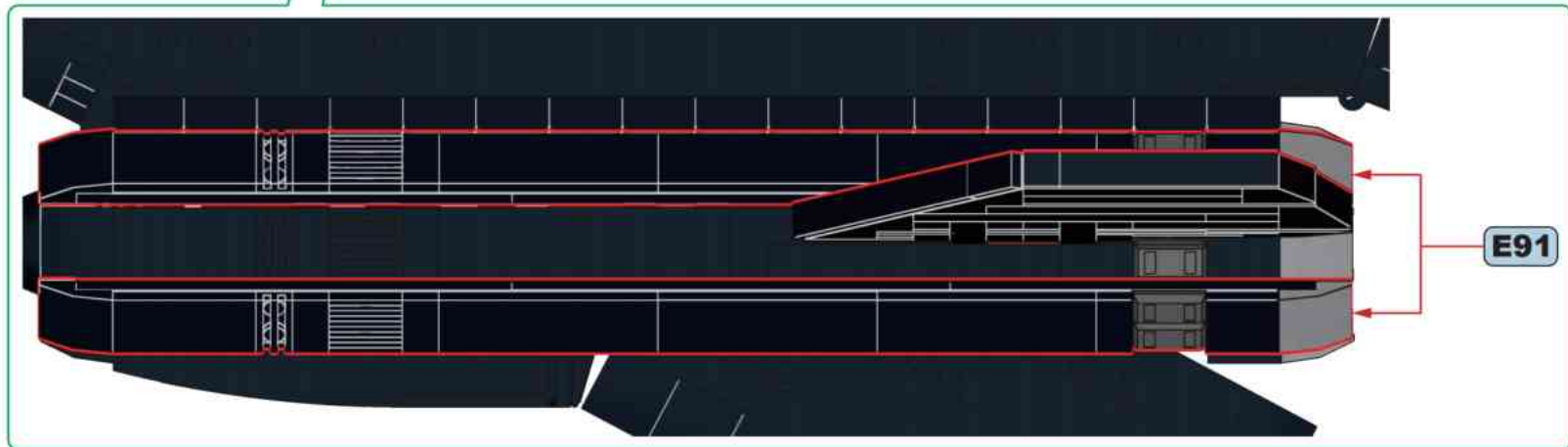

**E91**

**E93**

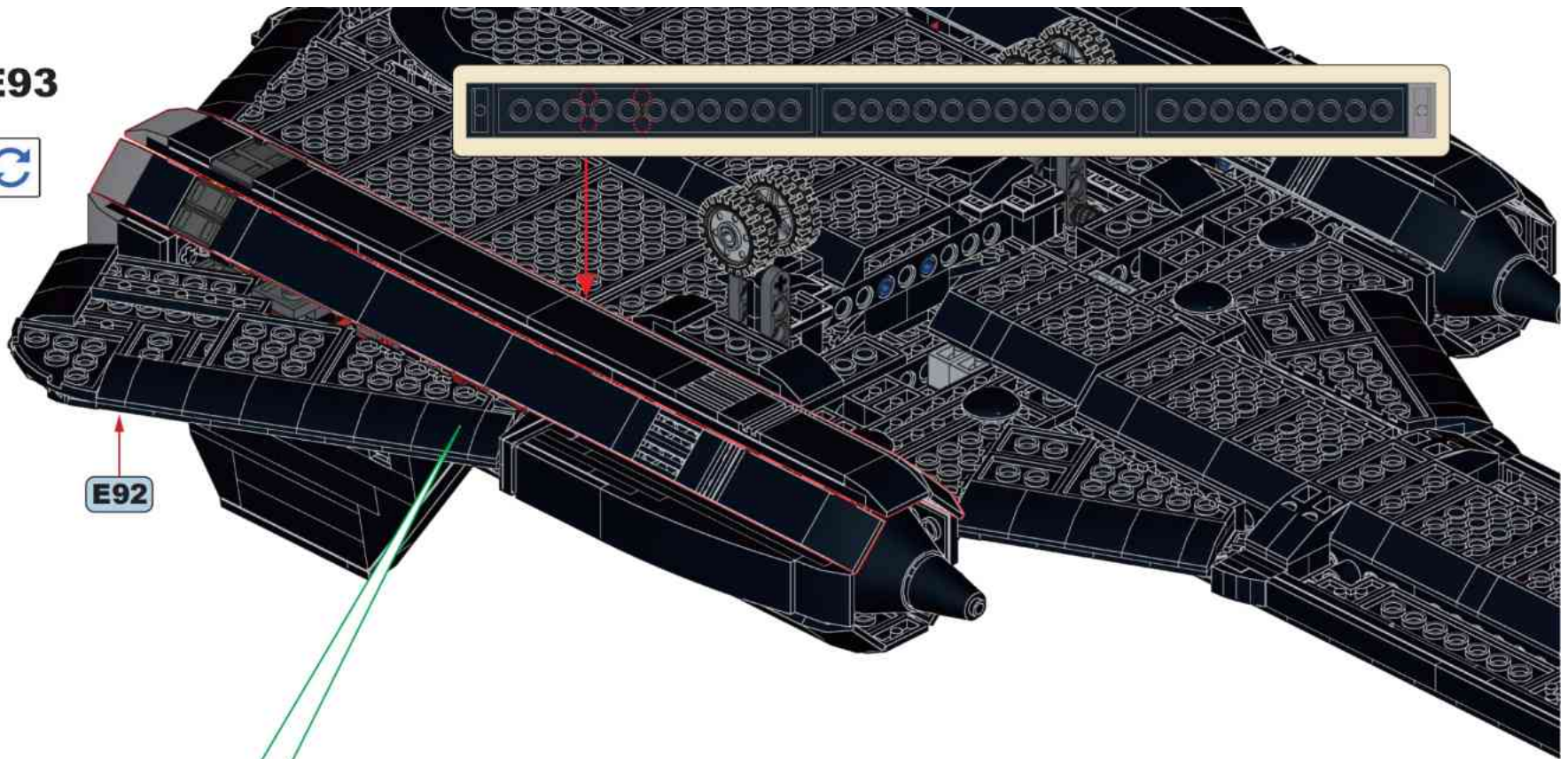

**E92**

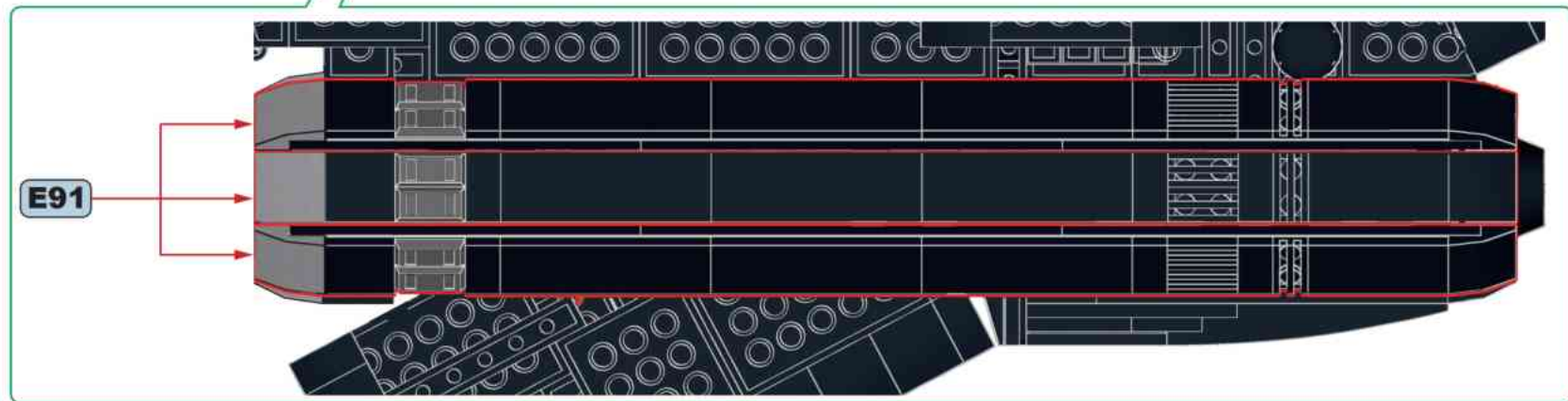

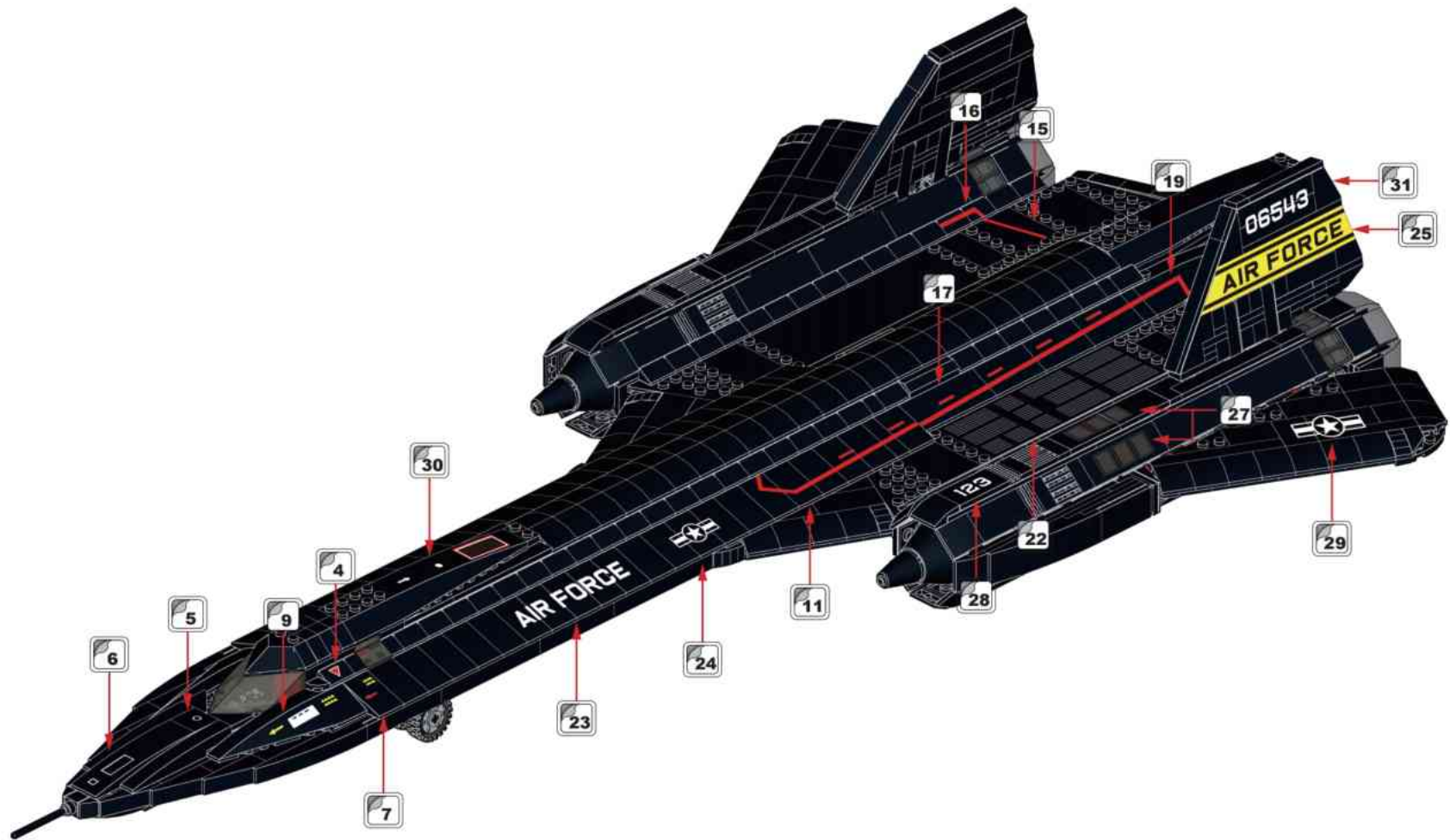

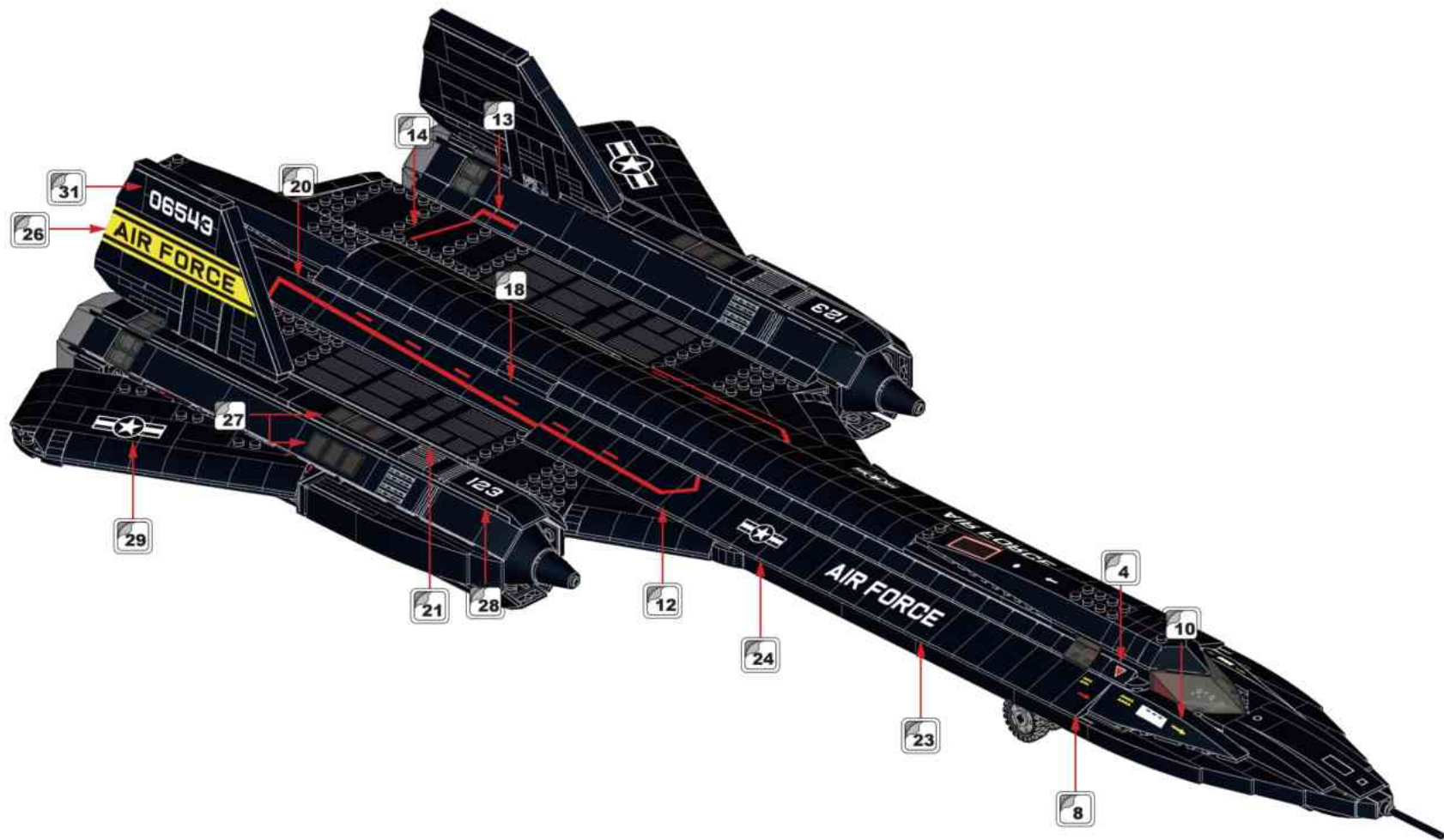

# LOGO'S ET





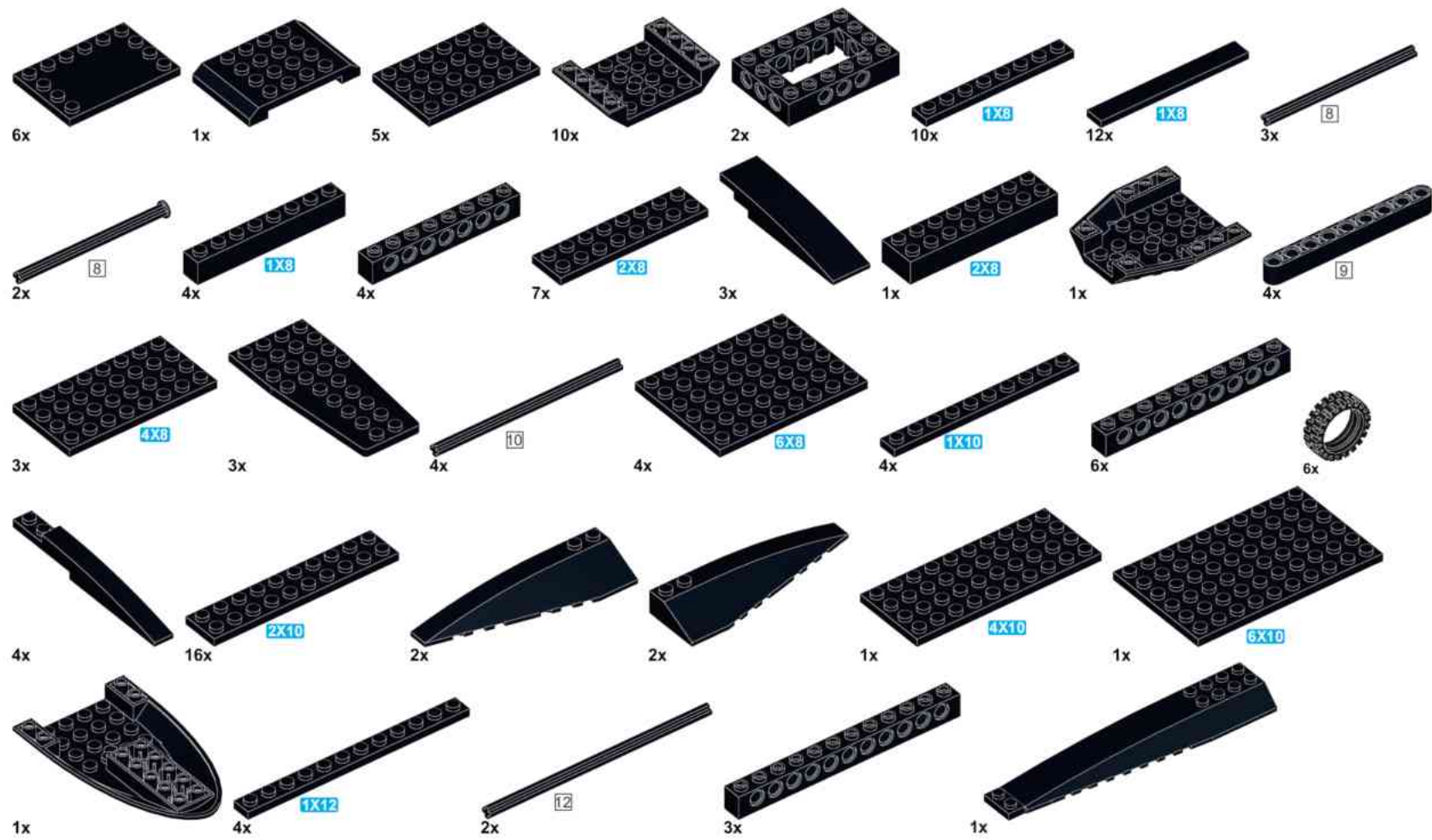

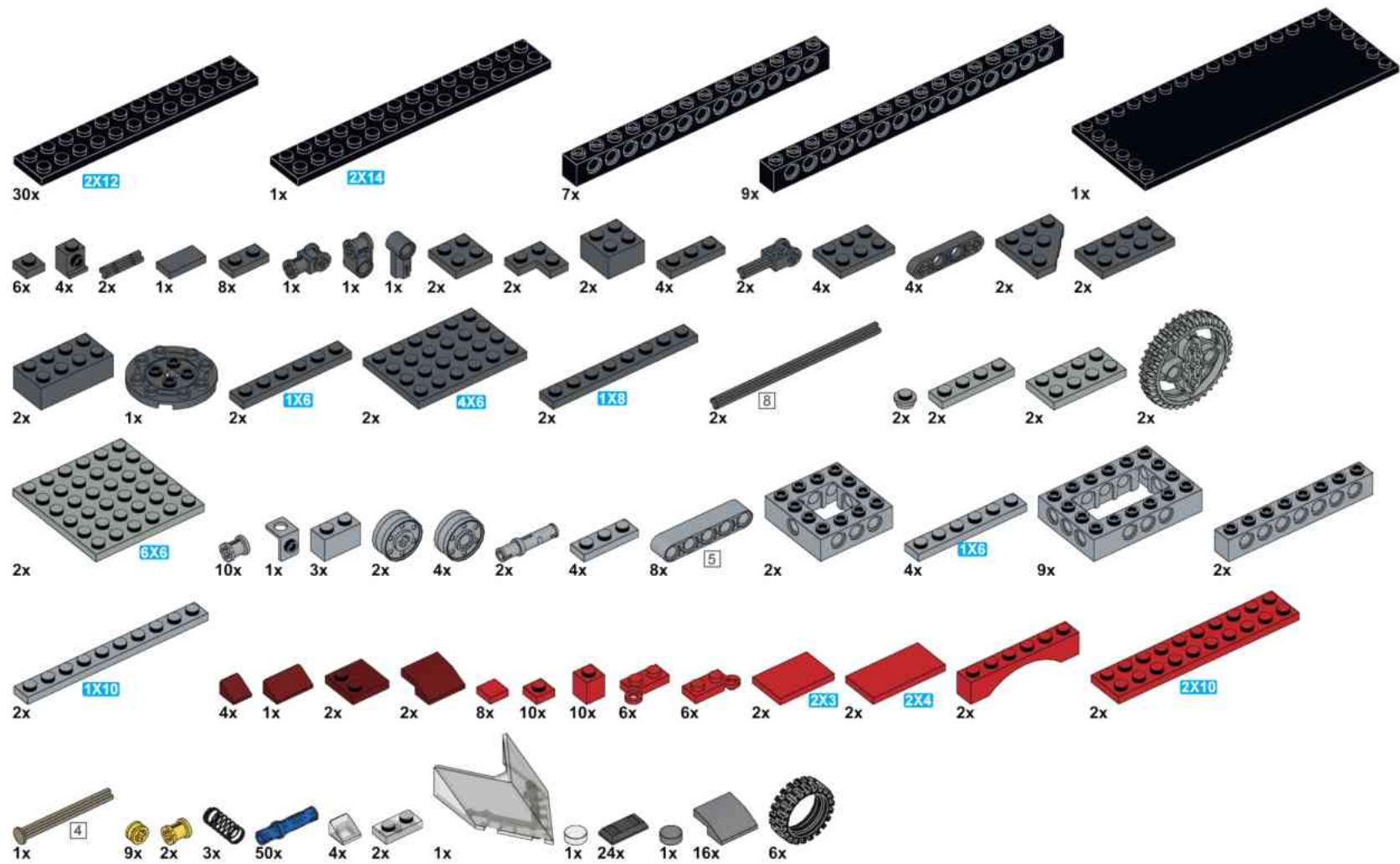





NO.33041

# SR★71 Blackbird