



NO.677

TECHNOLOGIE





1

1

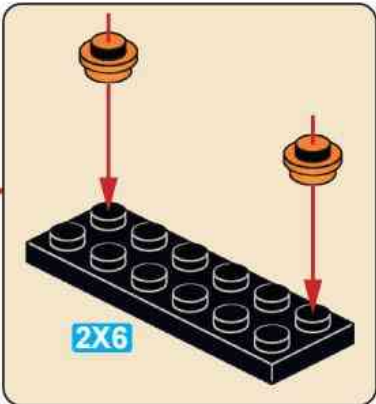
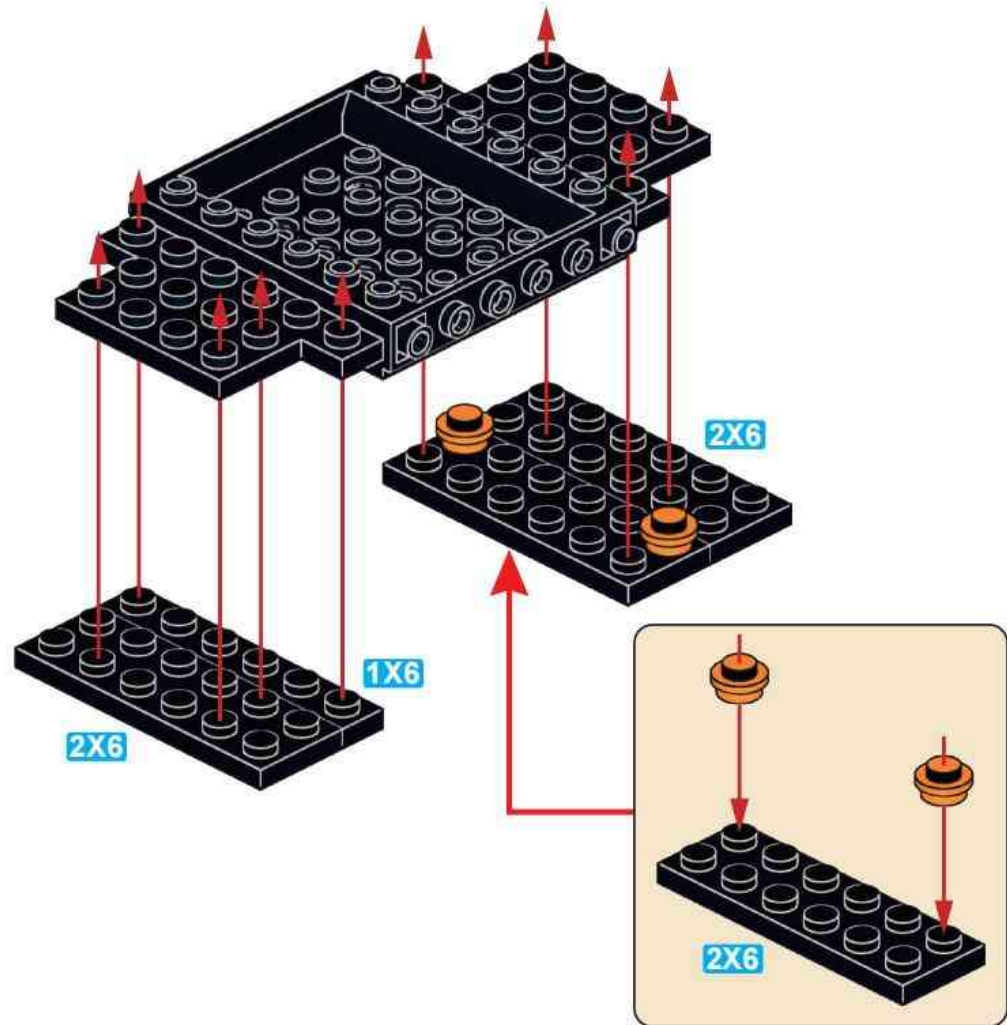

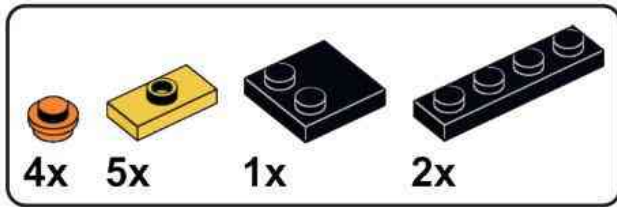

2

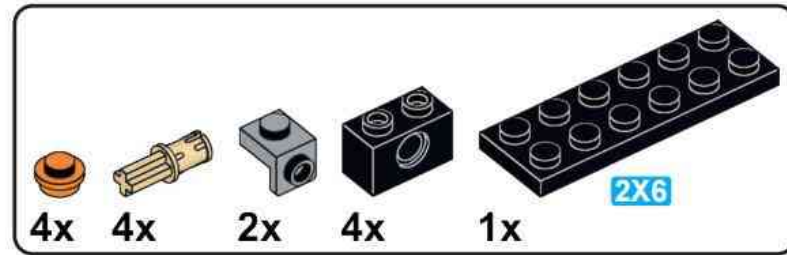
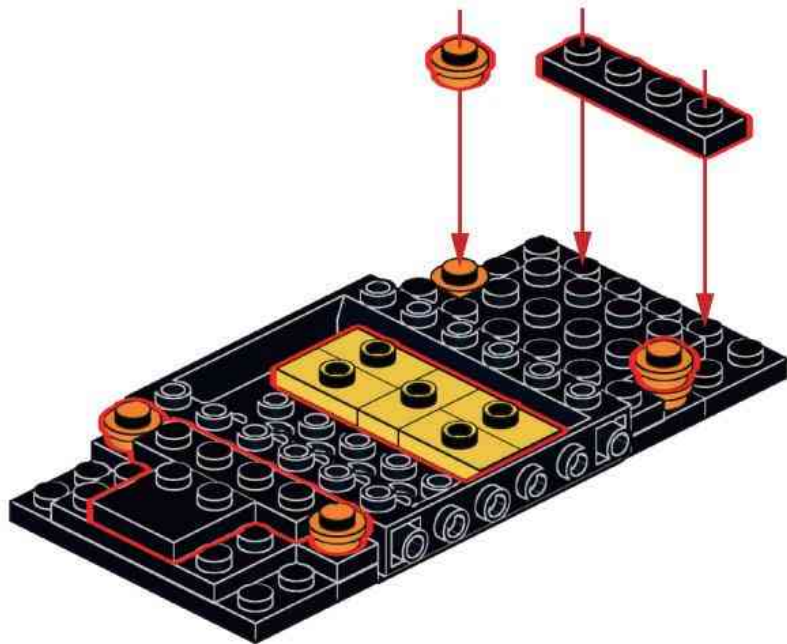

3

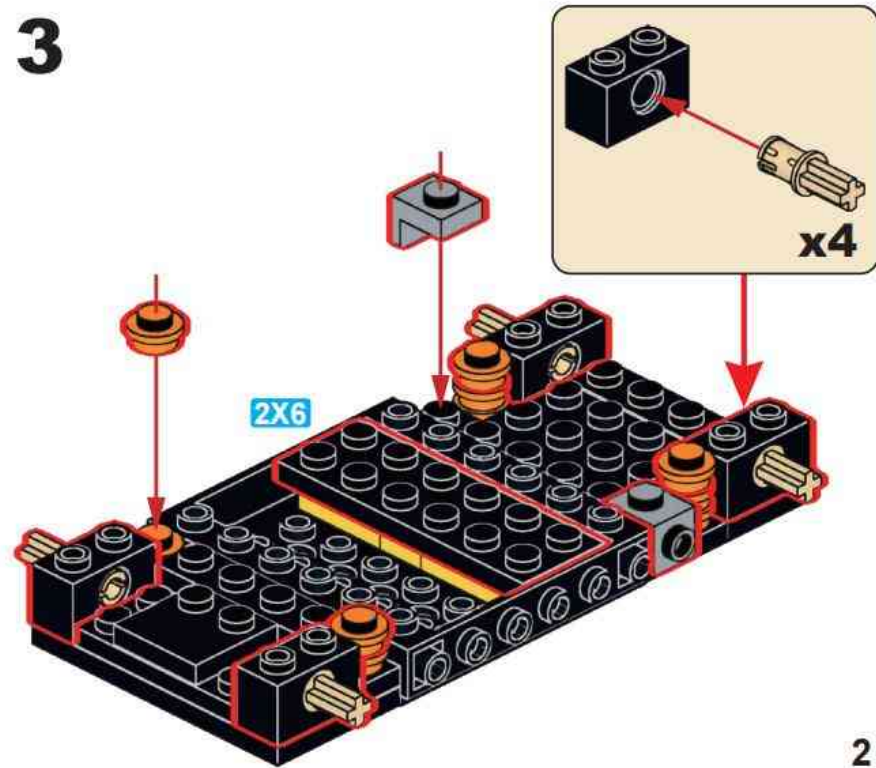

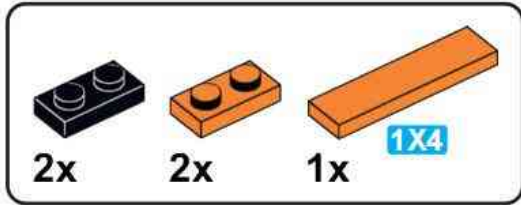

4

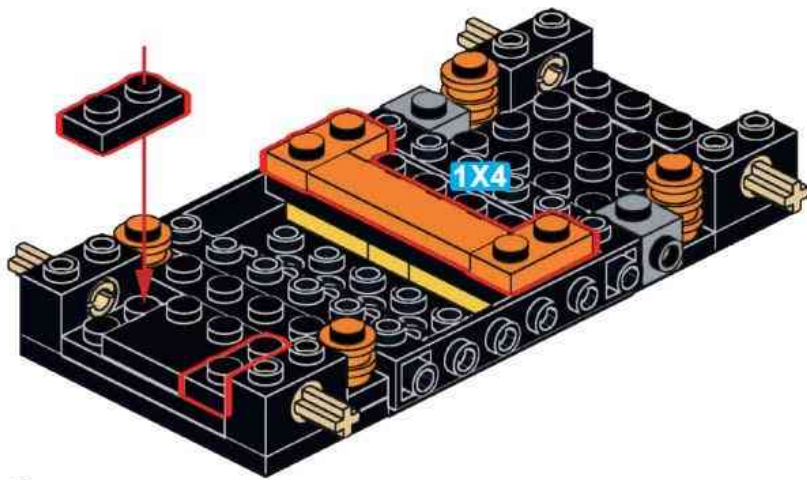

3

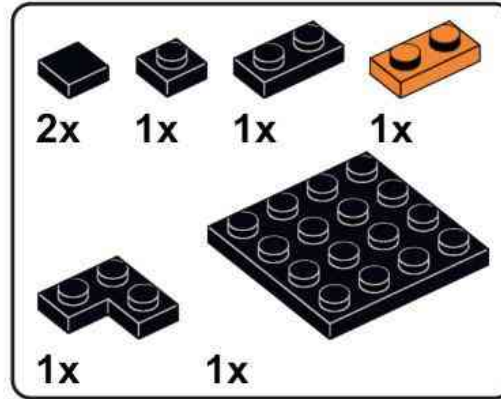

5

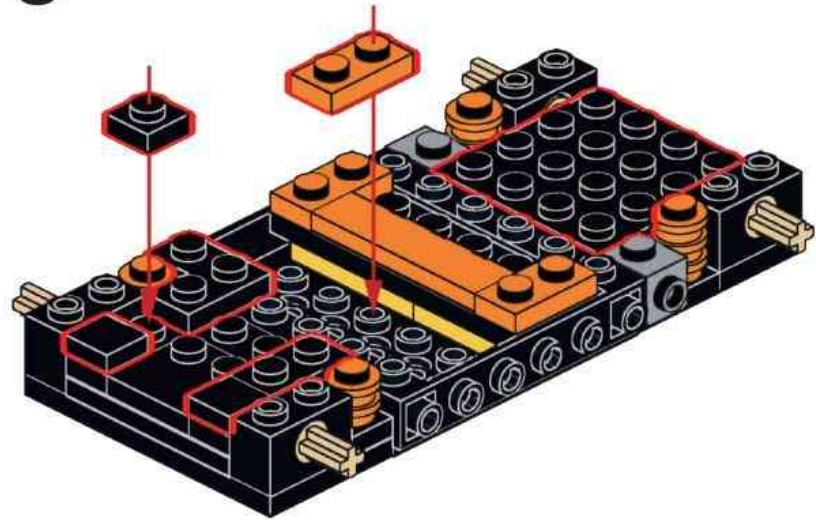

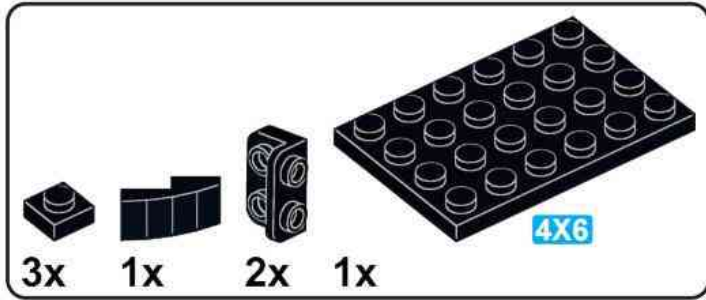

6

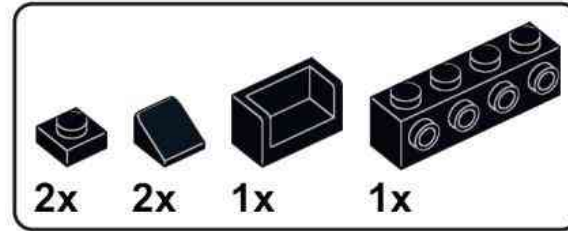
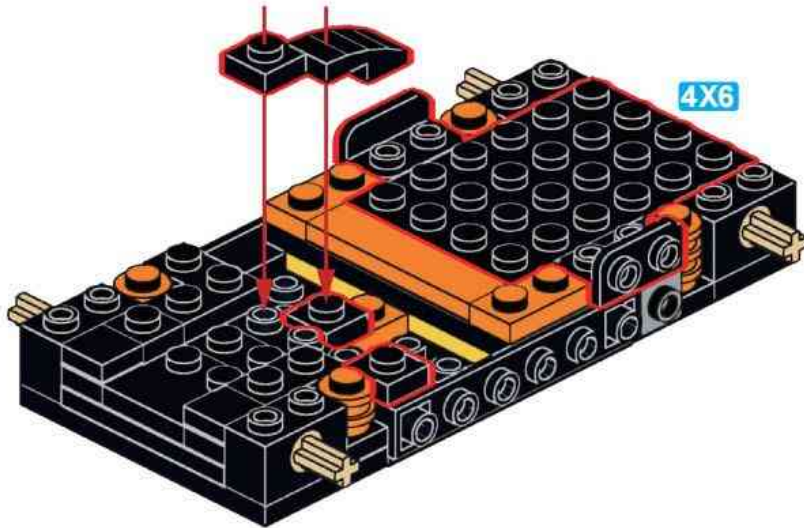

7

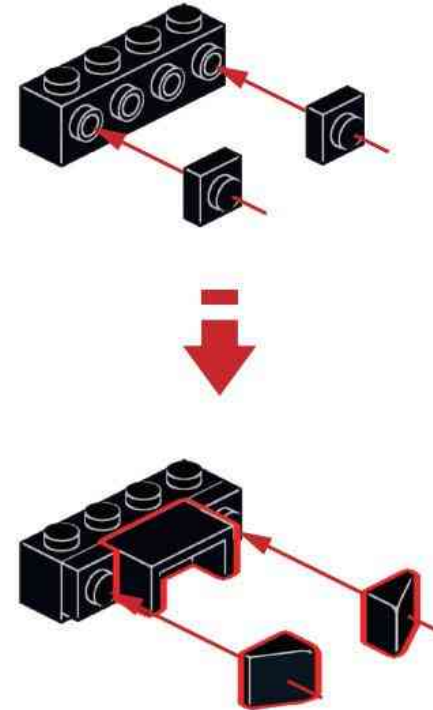

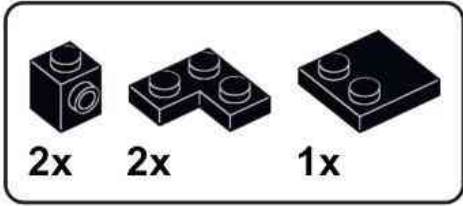

8

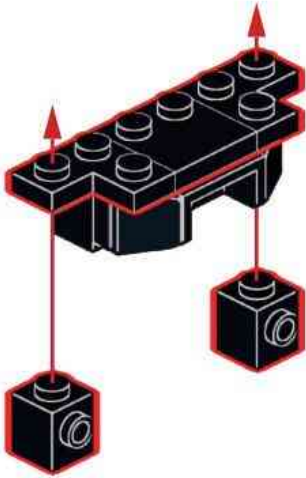

5

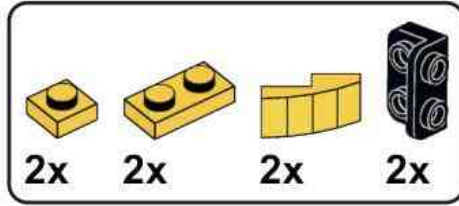

9

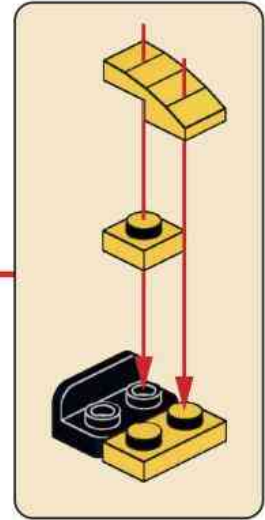
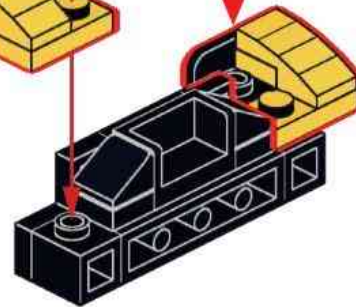
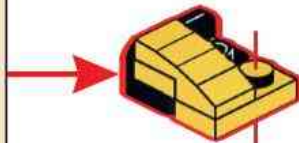
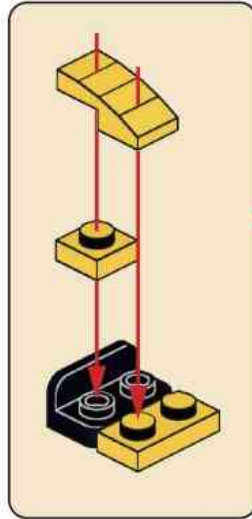

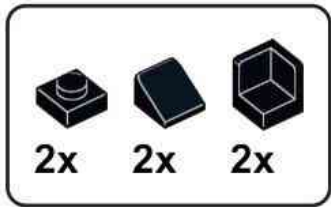

10

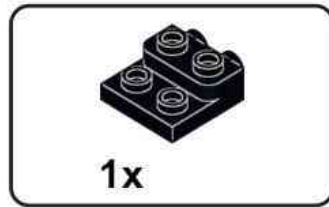
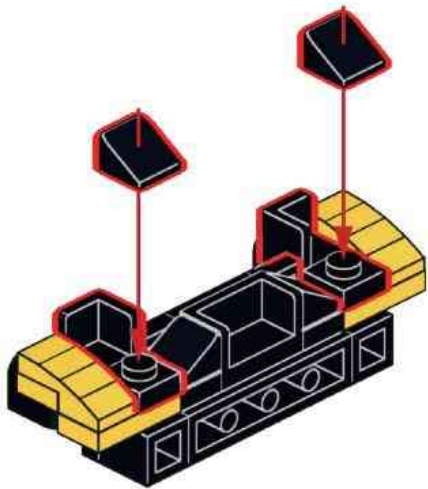

11

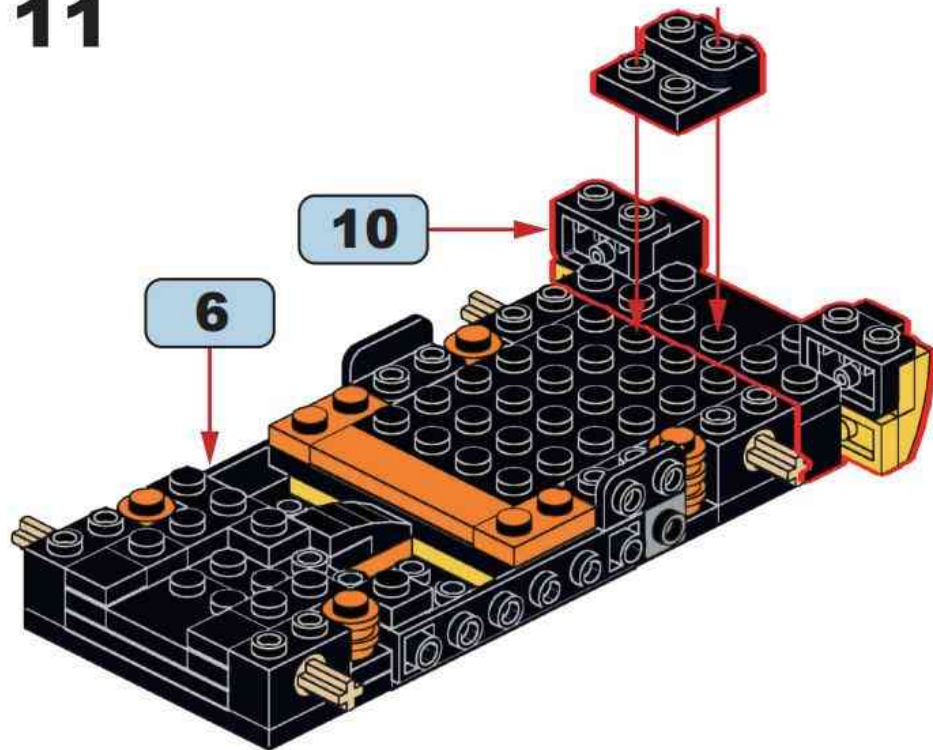

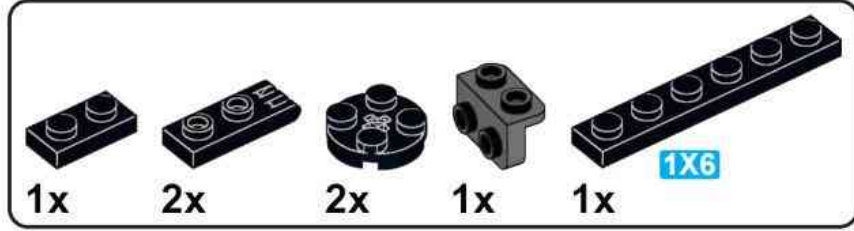

12

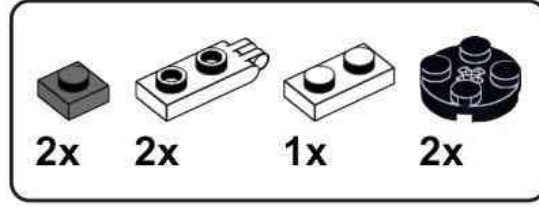
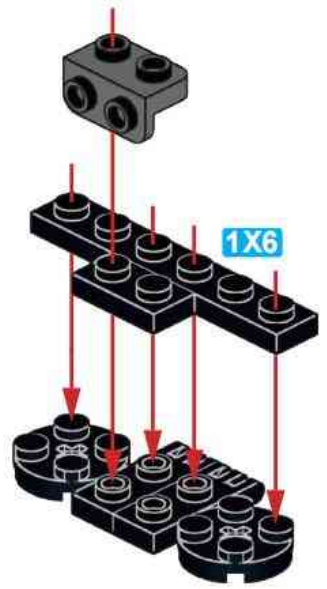

13

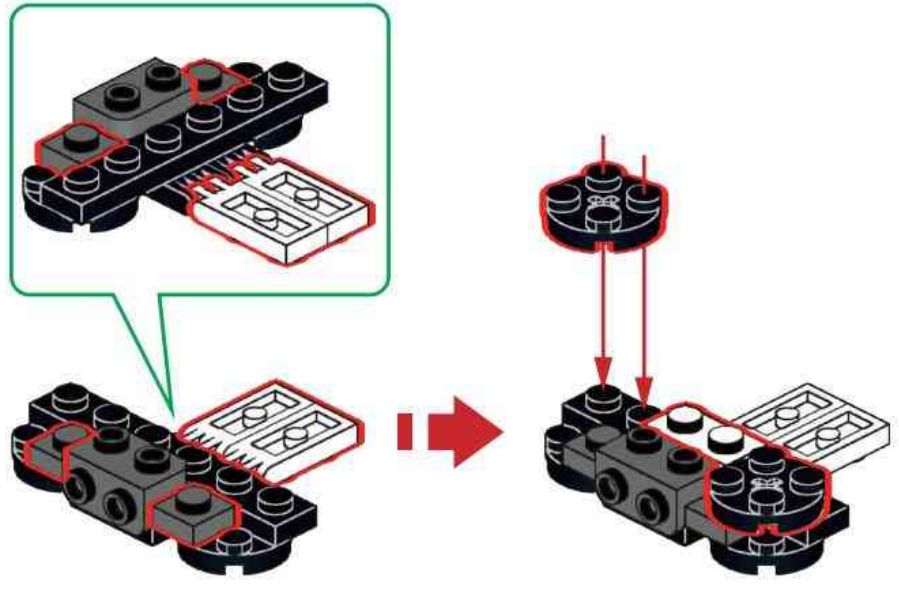

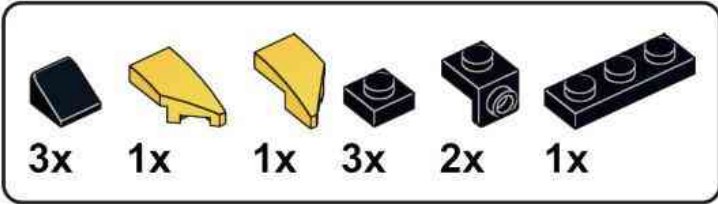

14

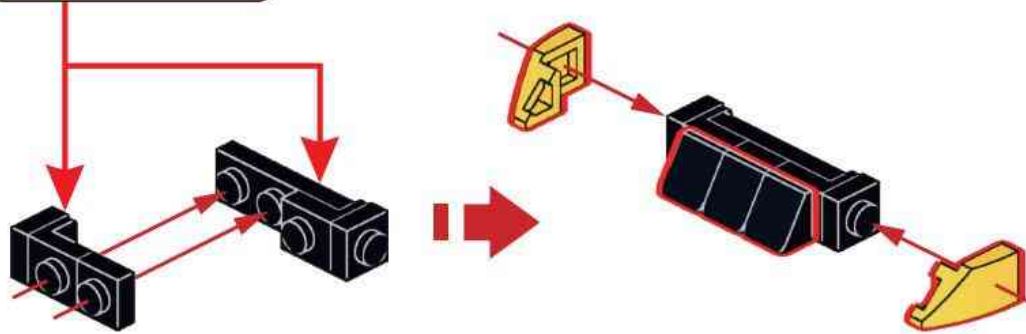
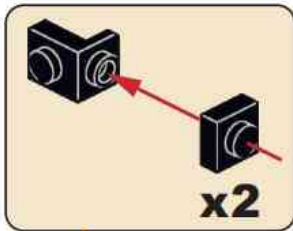

15

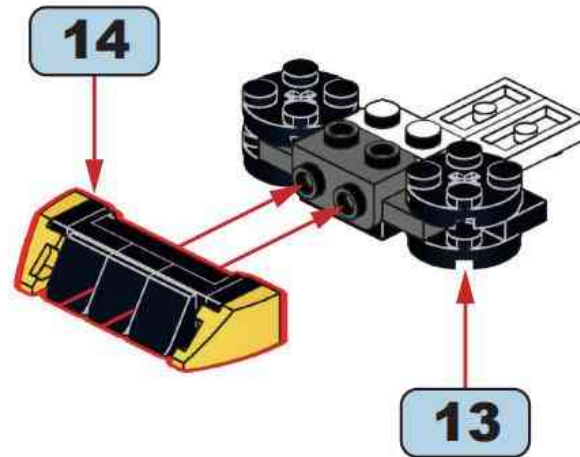

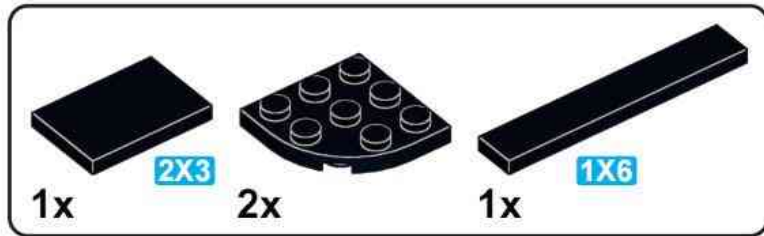

16

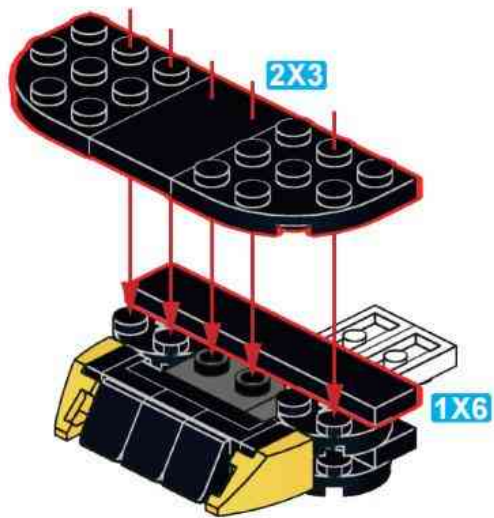

17

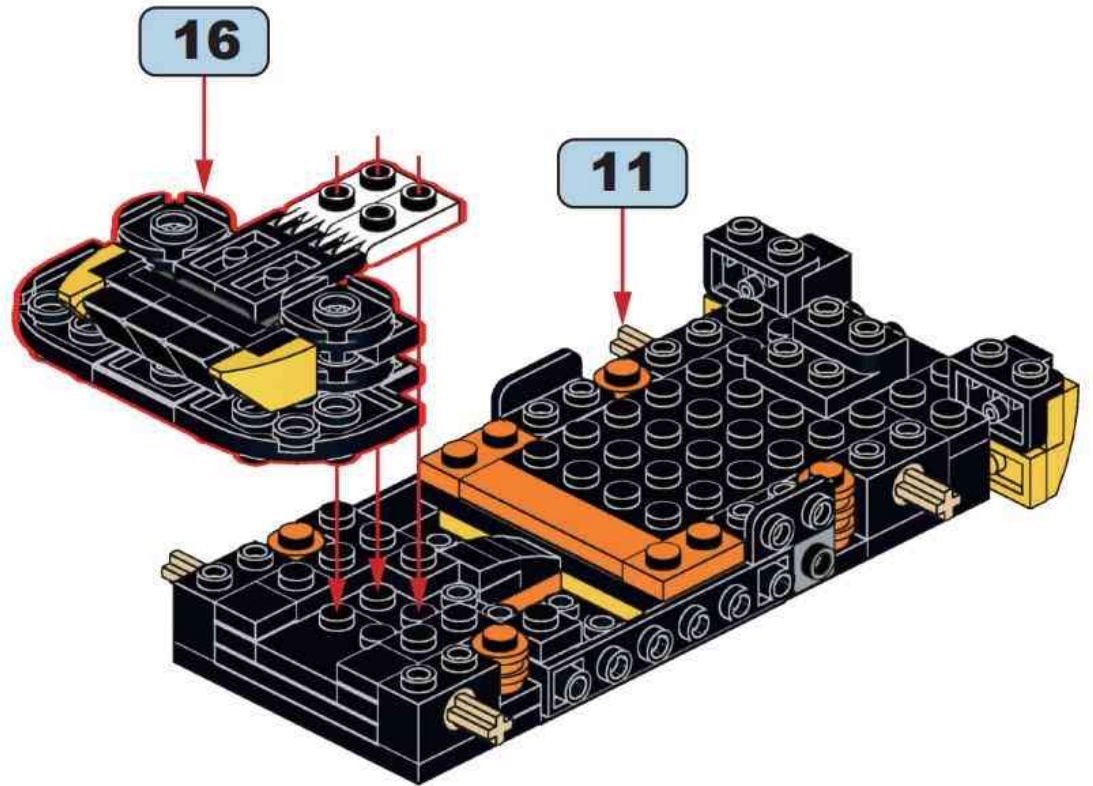

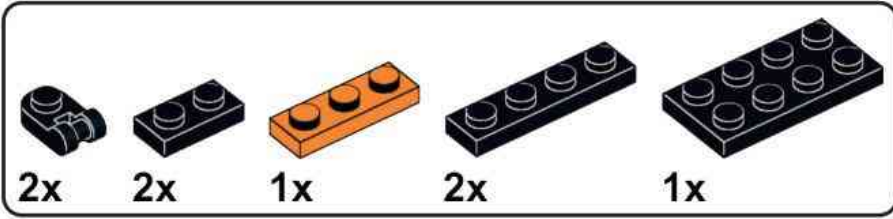

18

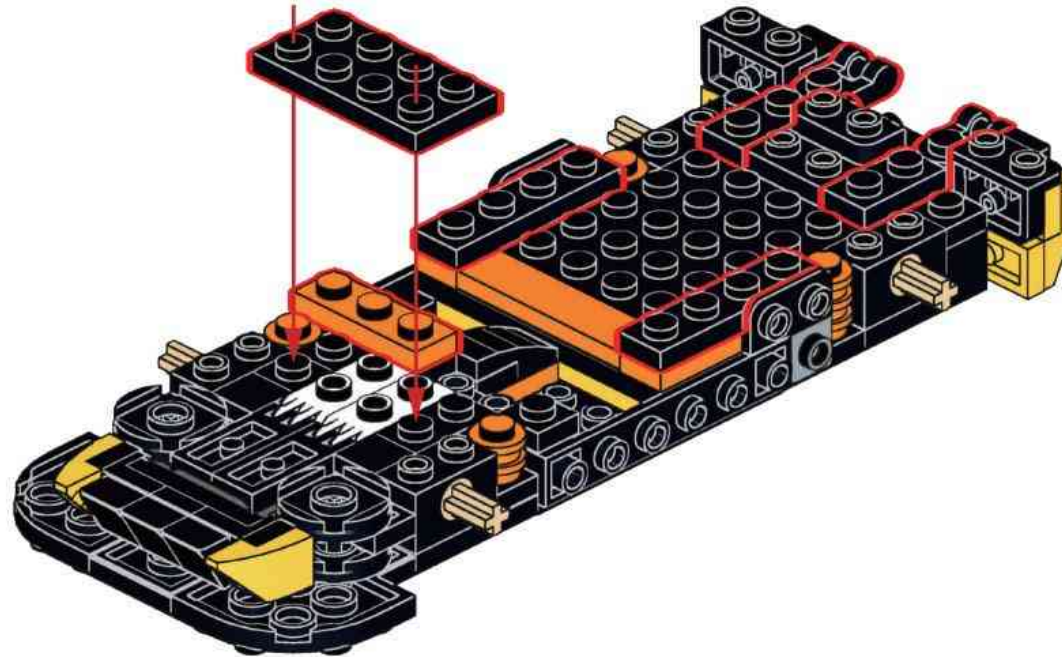

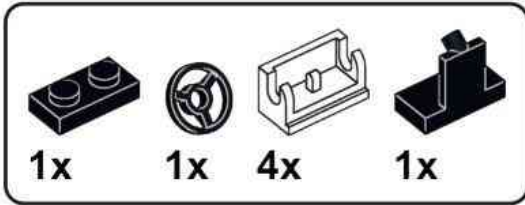

19

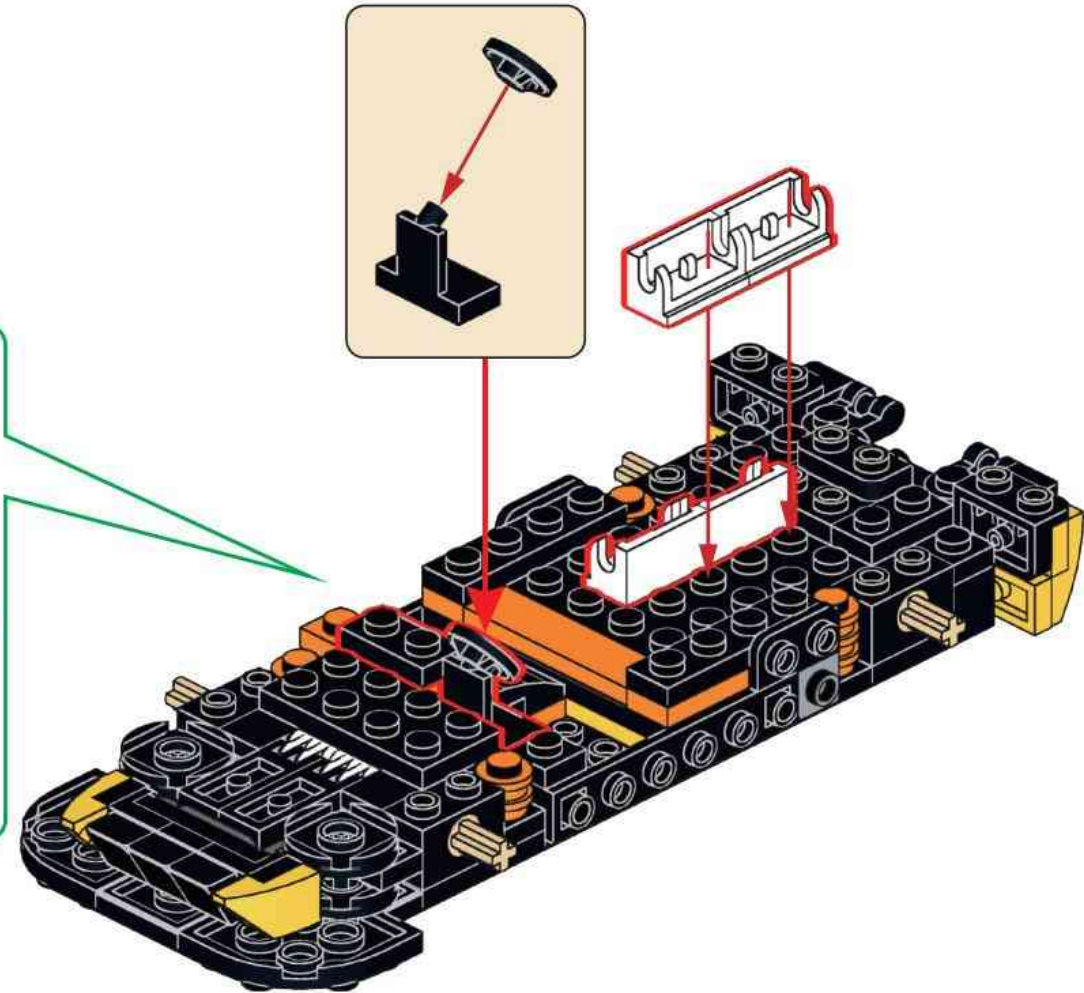
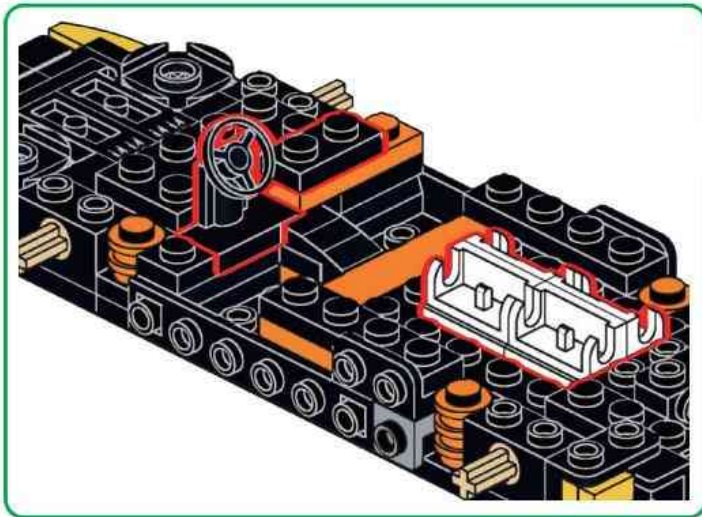

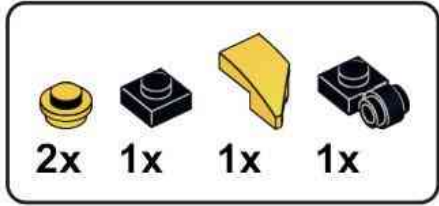

20

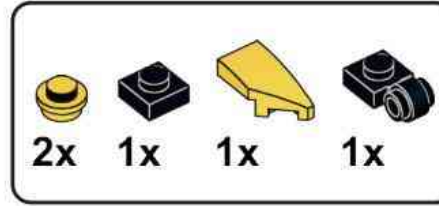
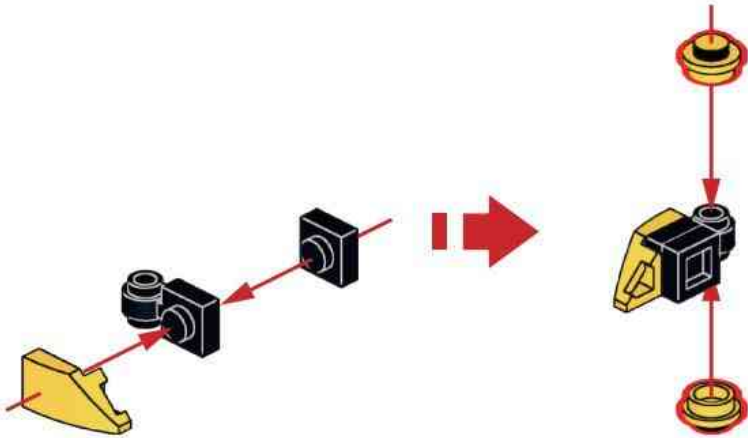

21

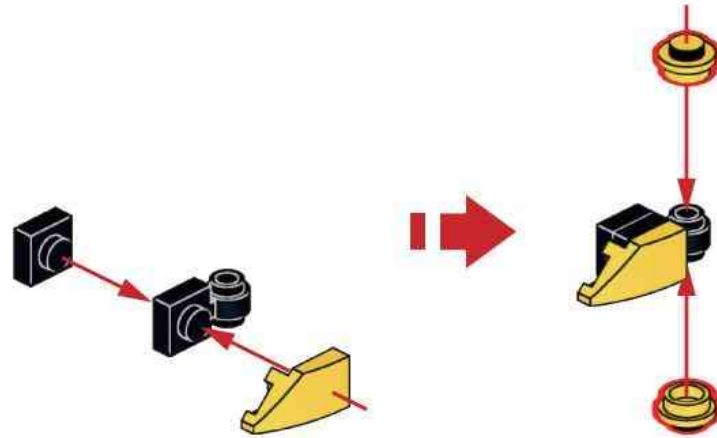

22

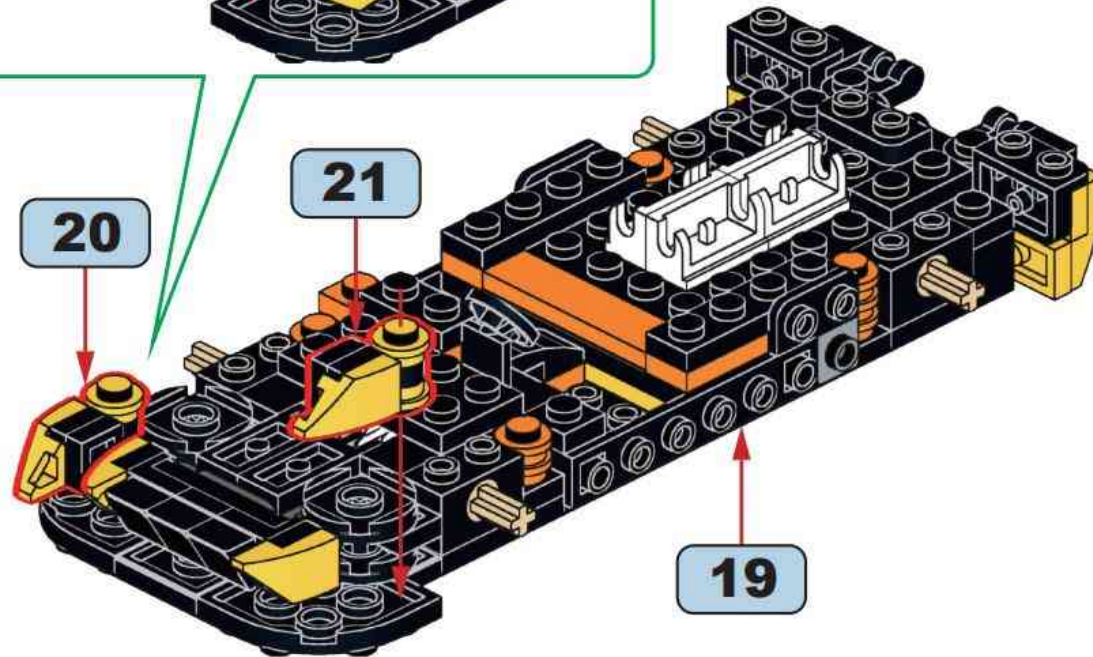
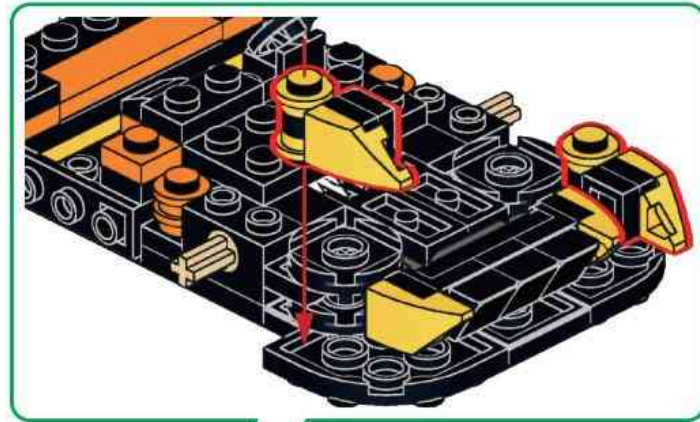

13

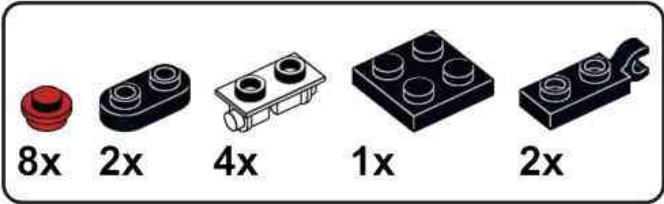

23

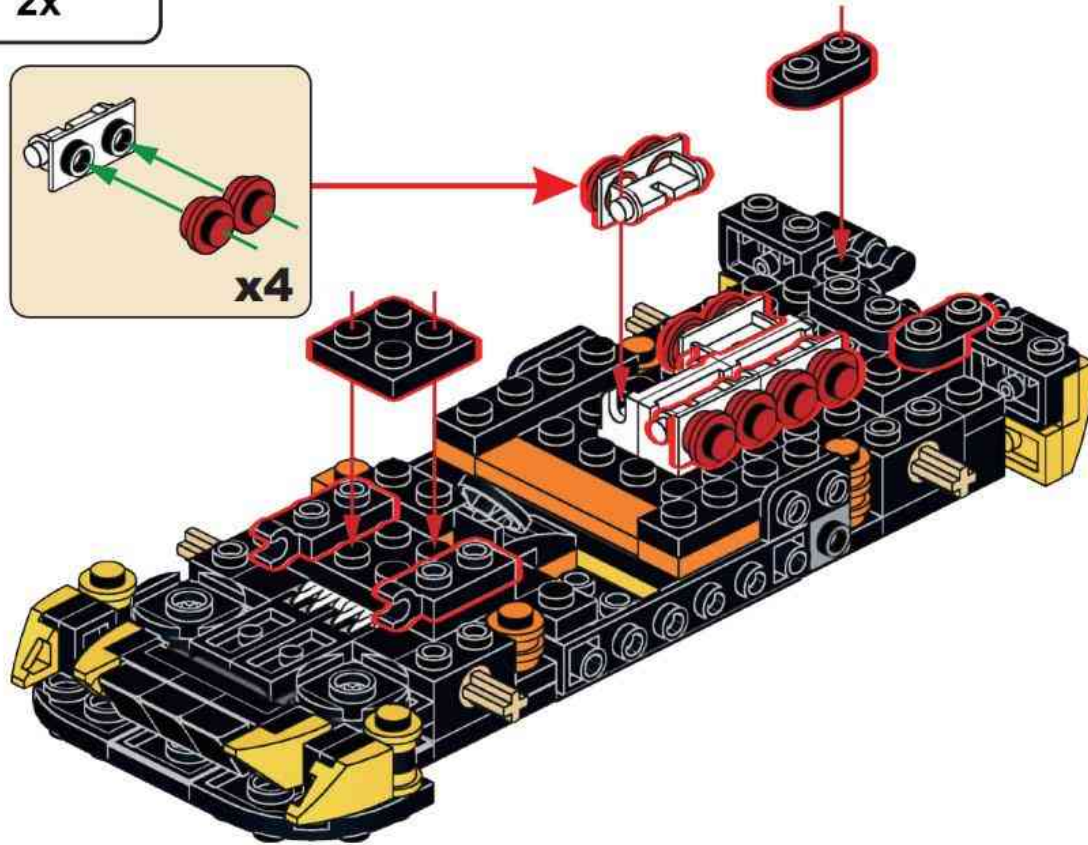
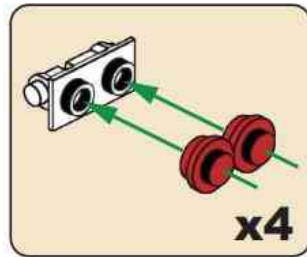

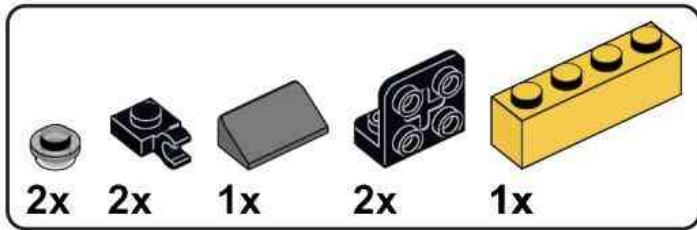

24

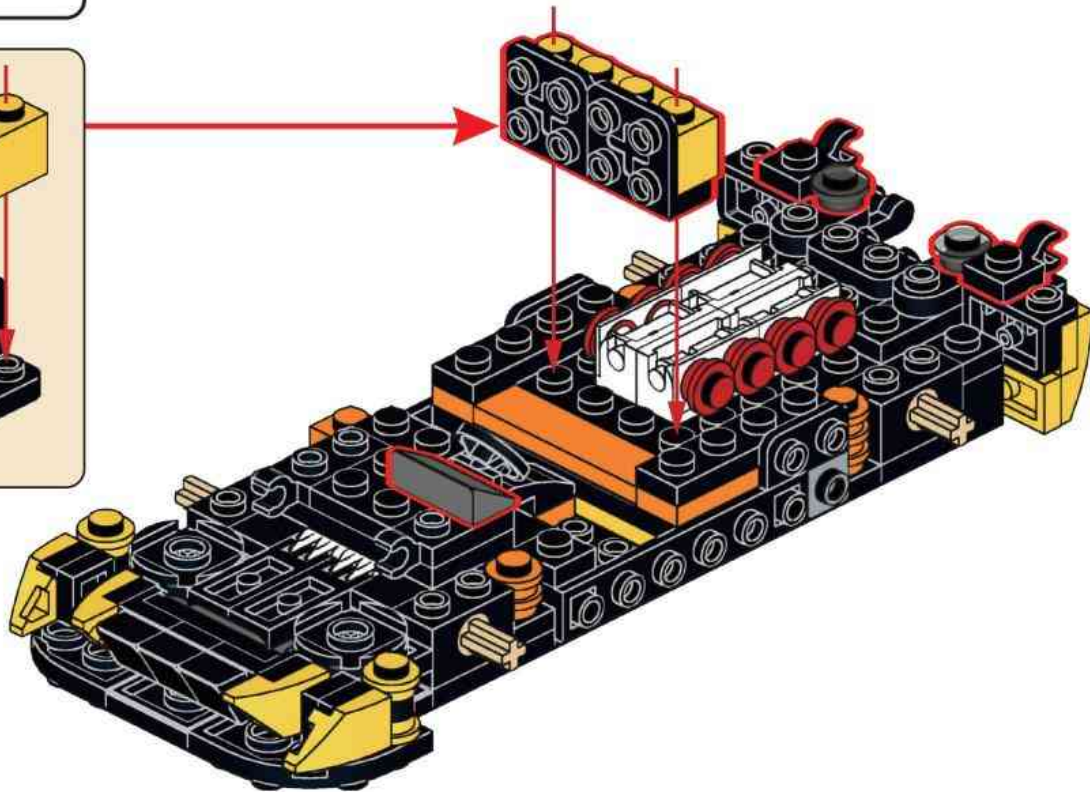
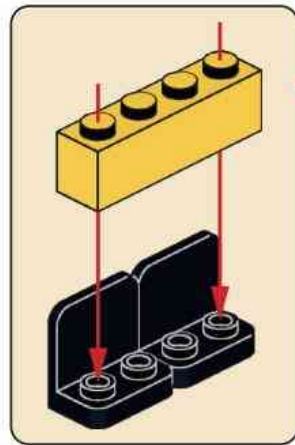

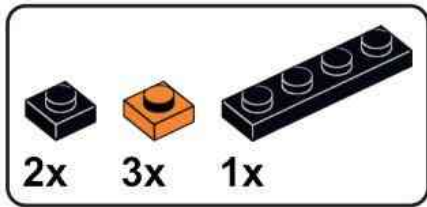

25

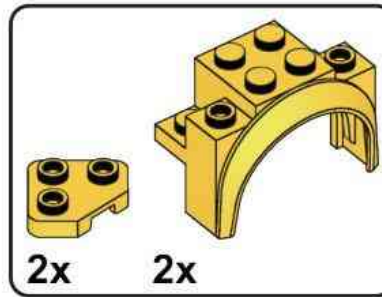
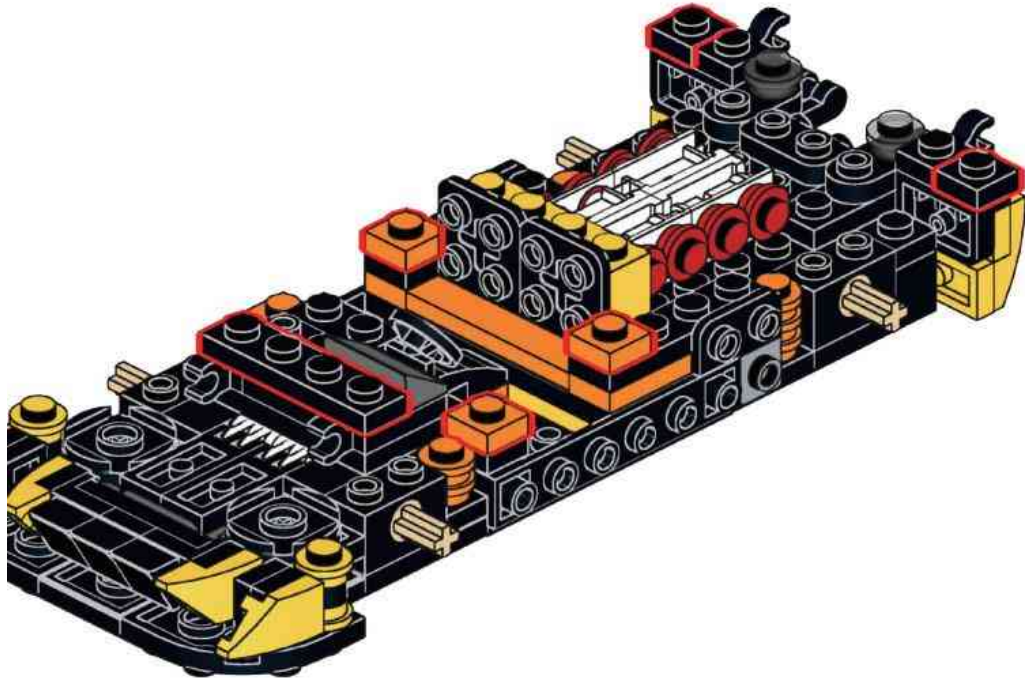

26

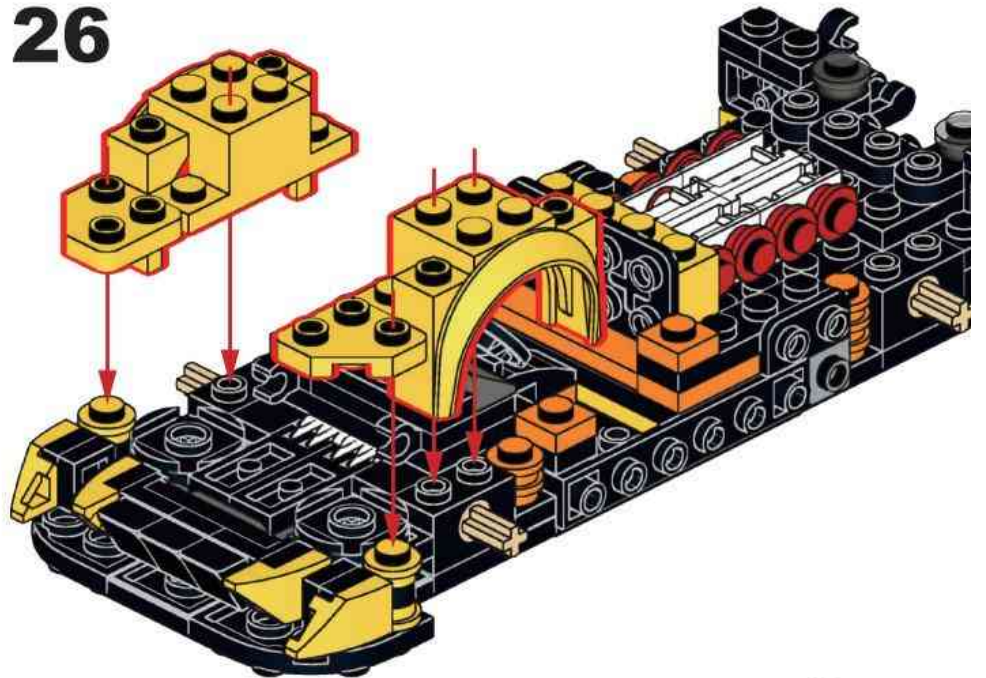

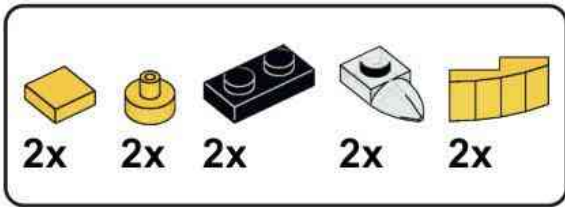

27

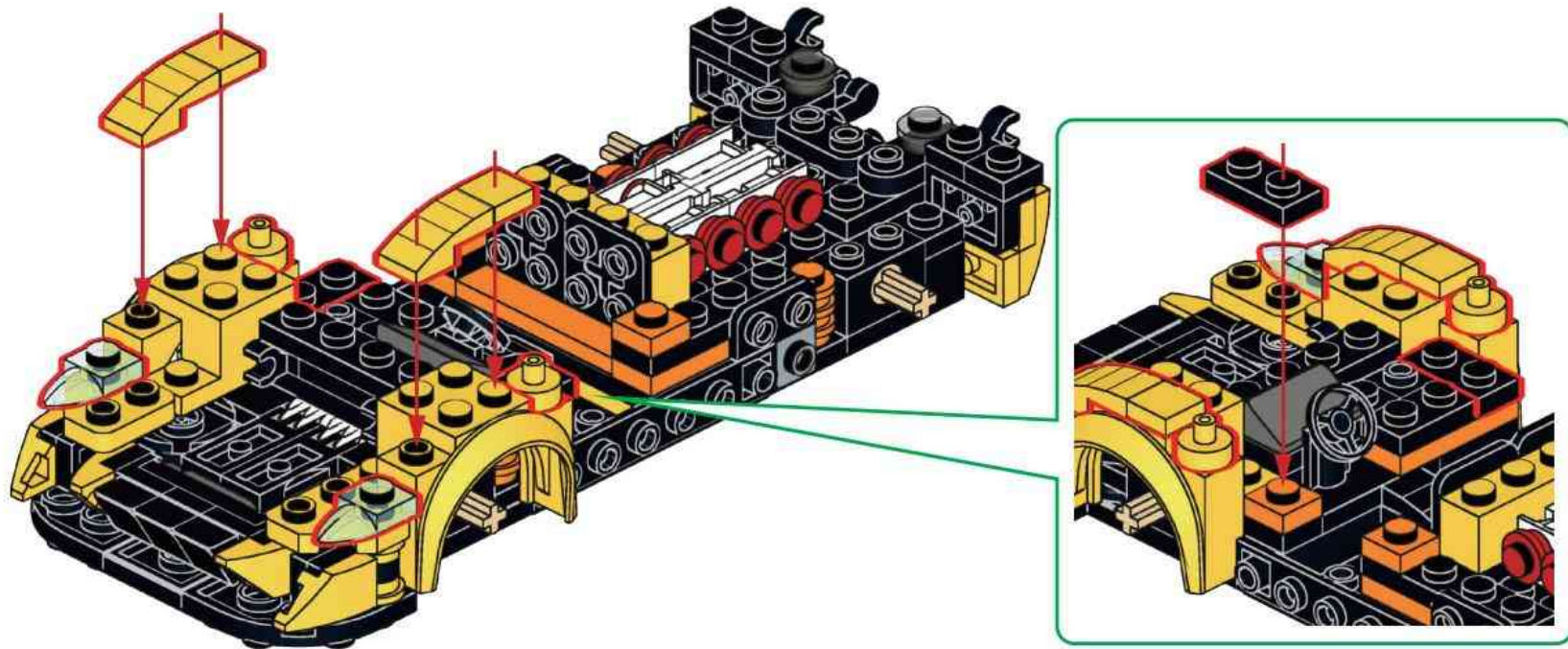

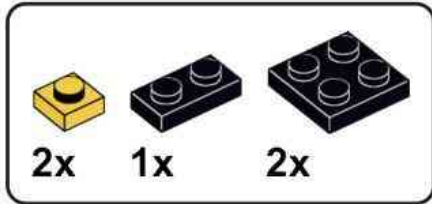

28

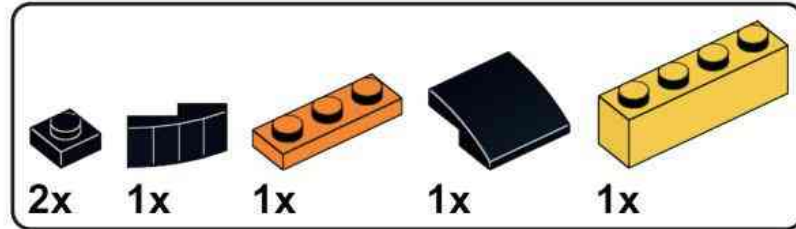
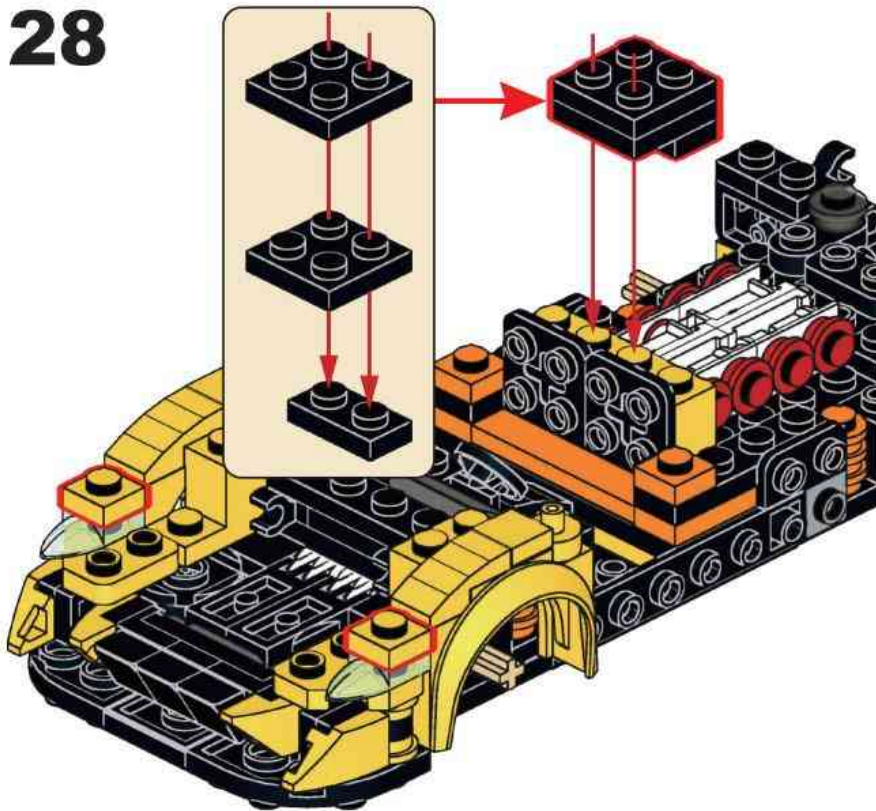

29

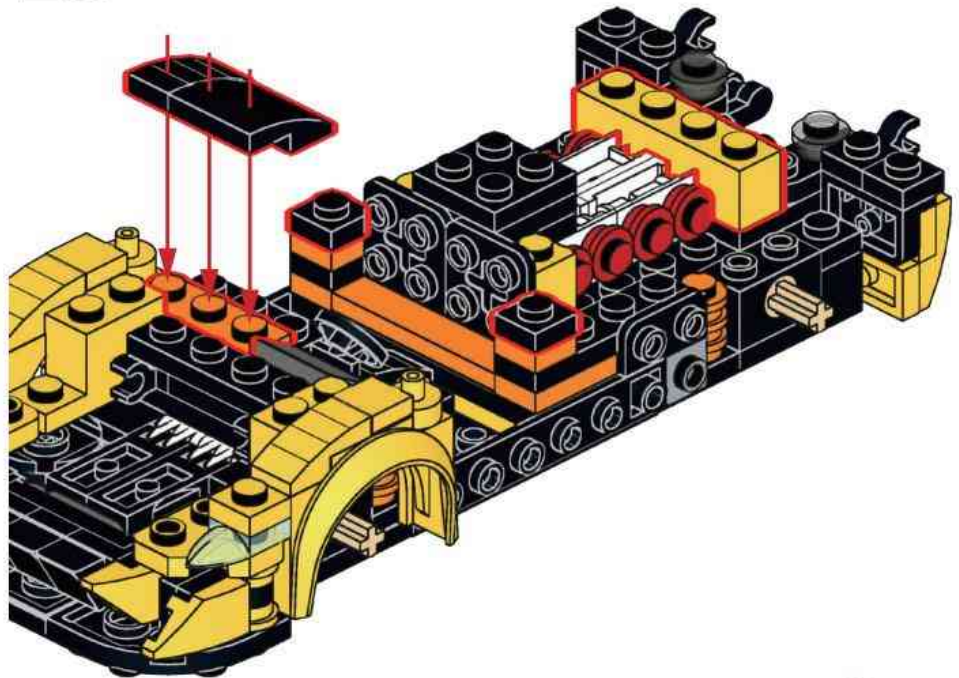

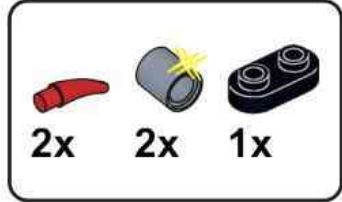

30

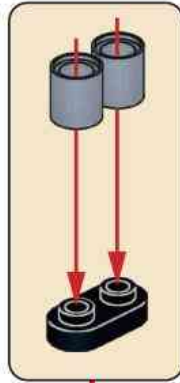
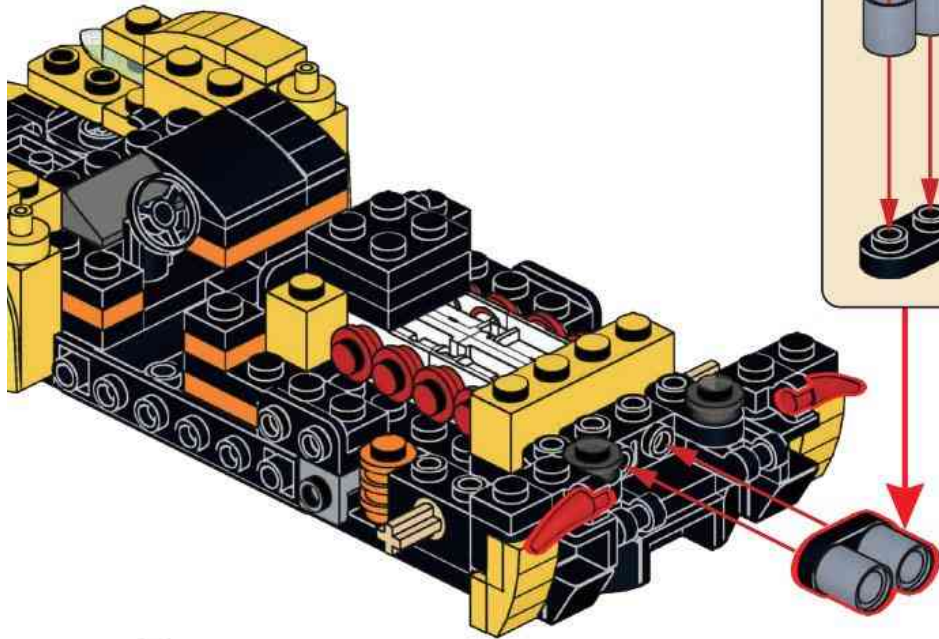

19



31

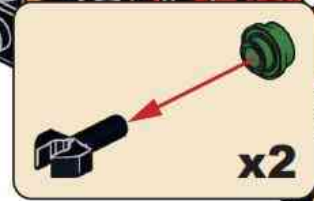
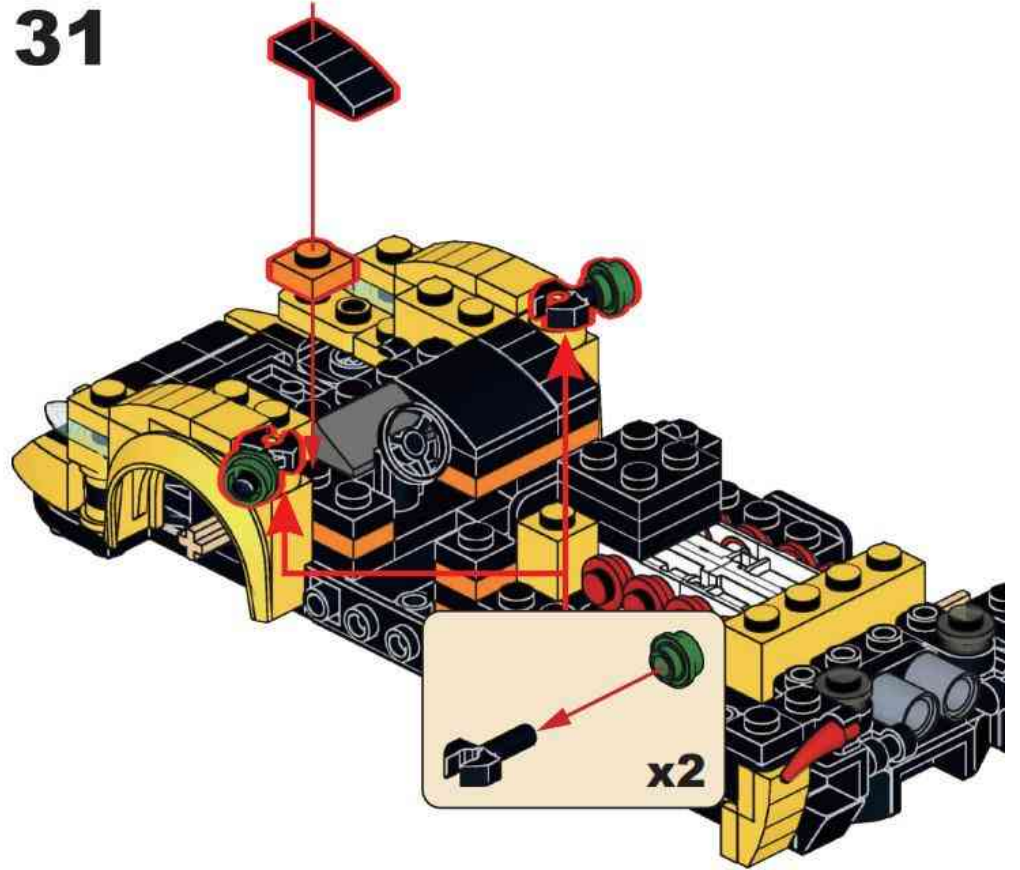

x2

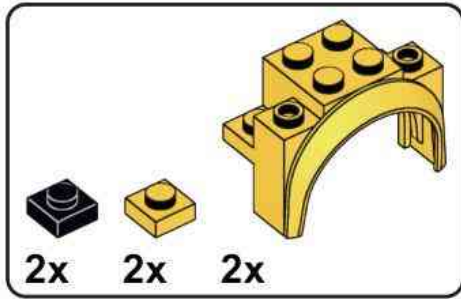

32

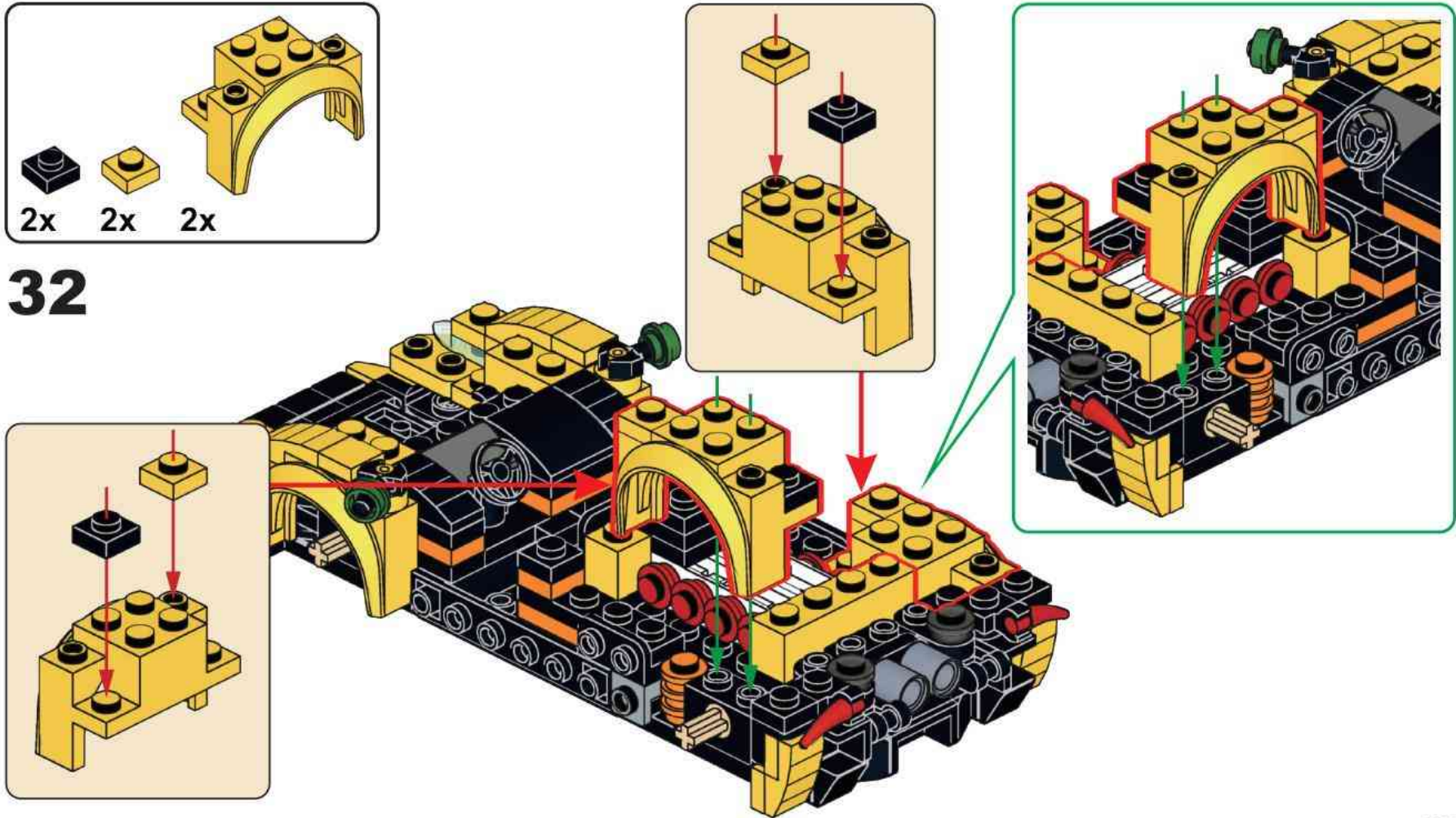

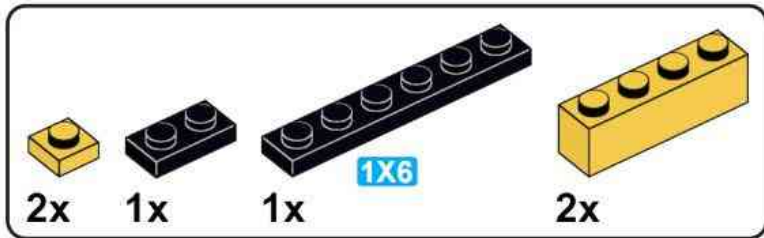

33

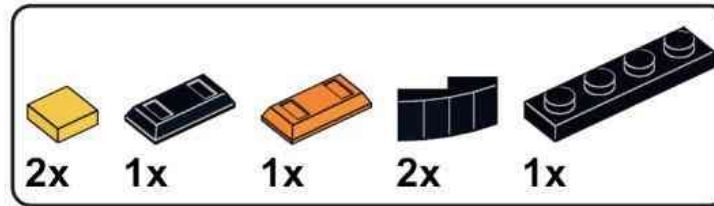
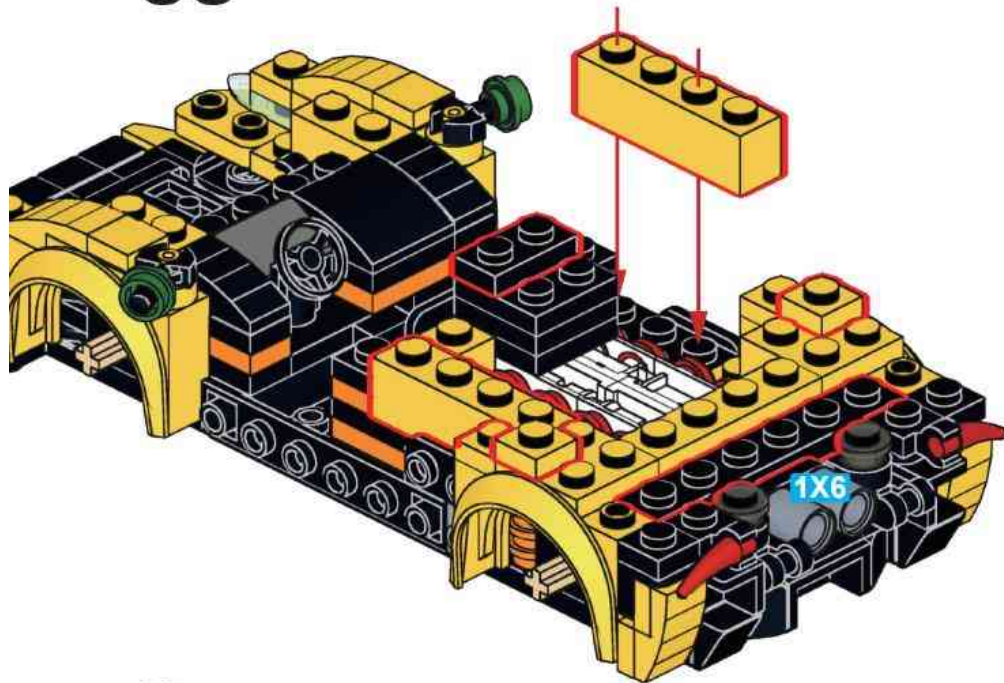

34

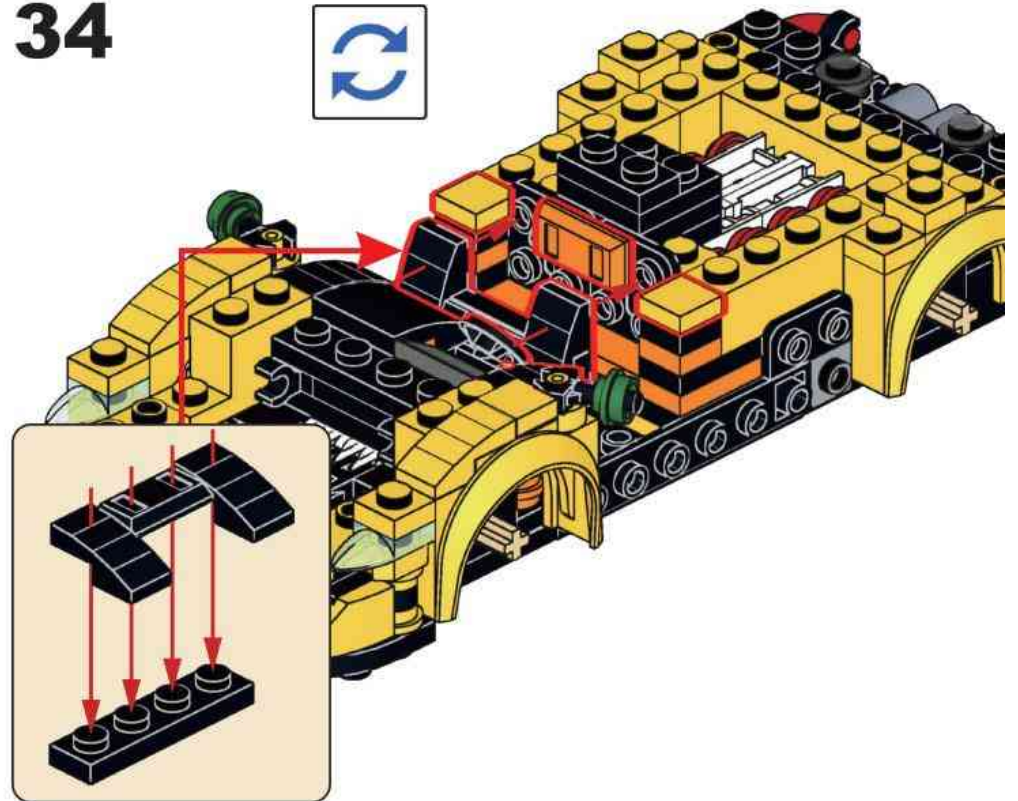

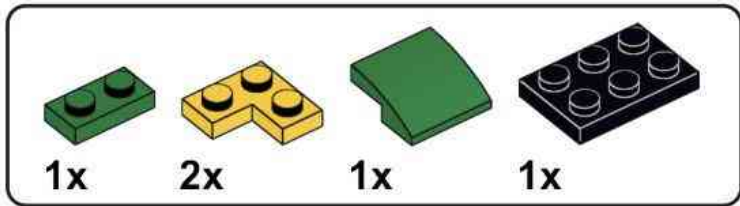

35

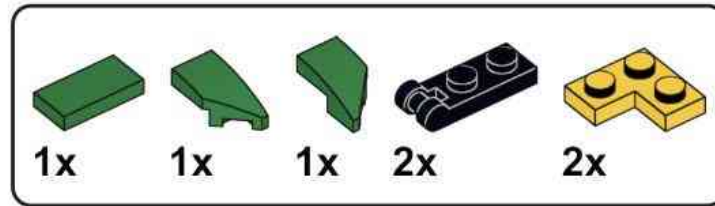
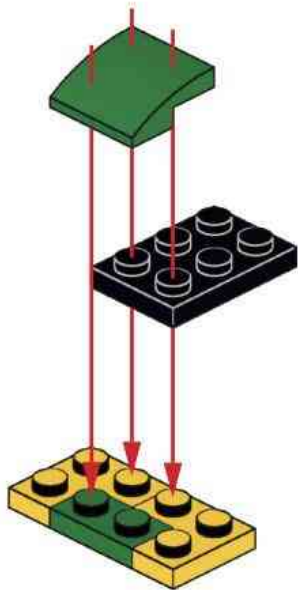

36

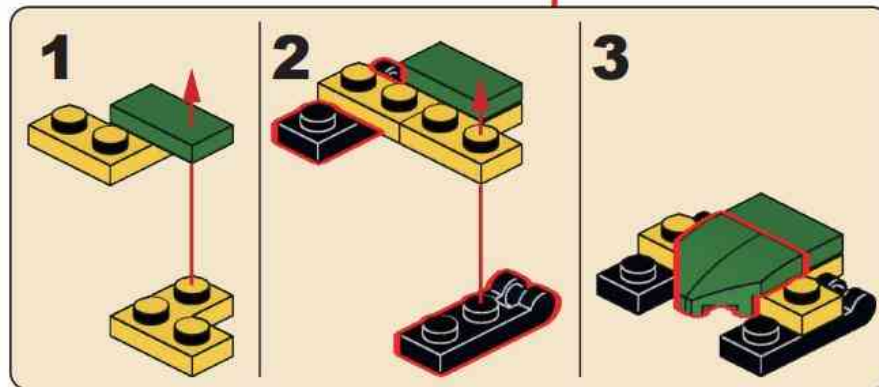
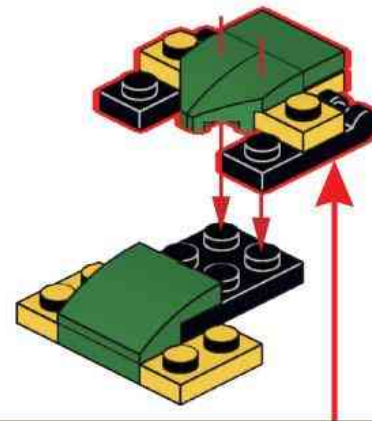

37

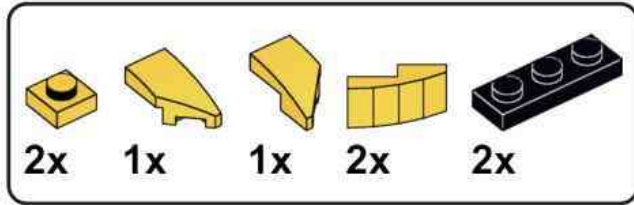
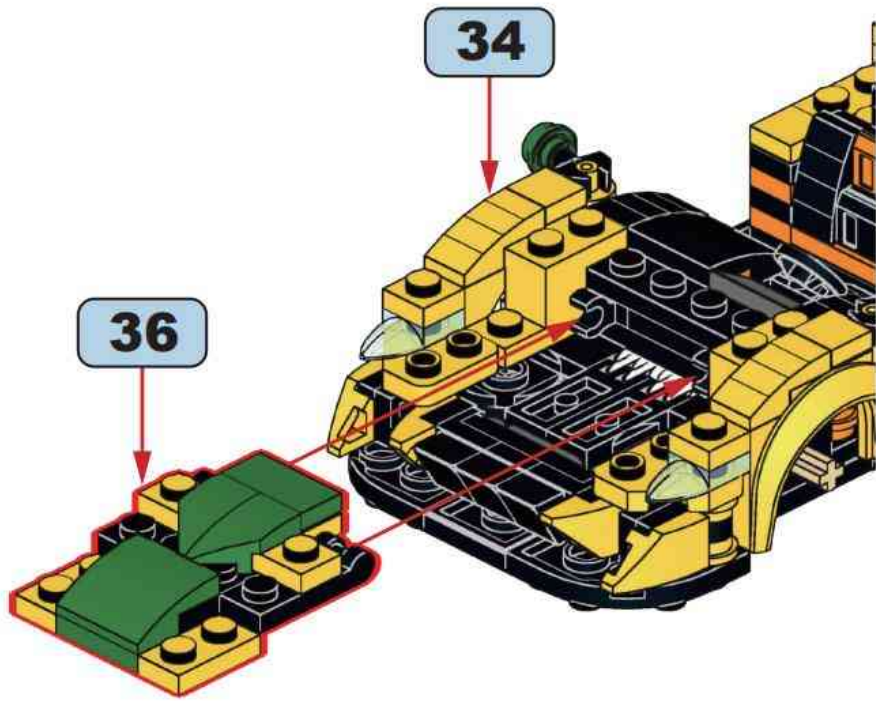

38

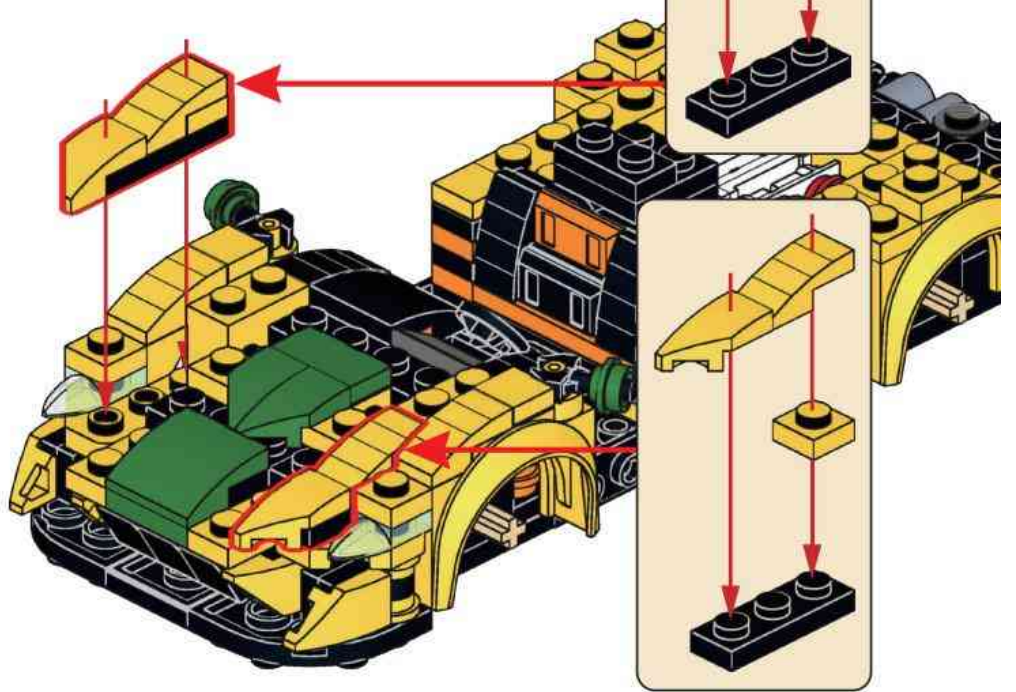

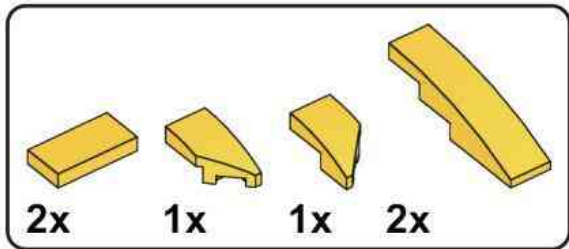

39

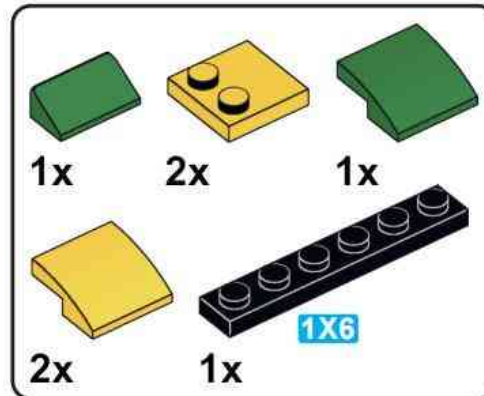
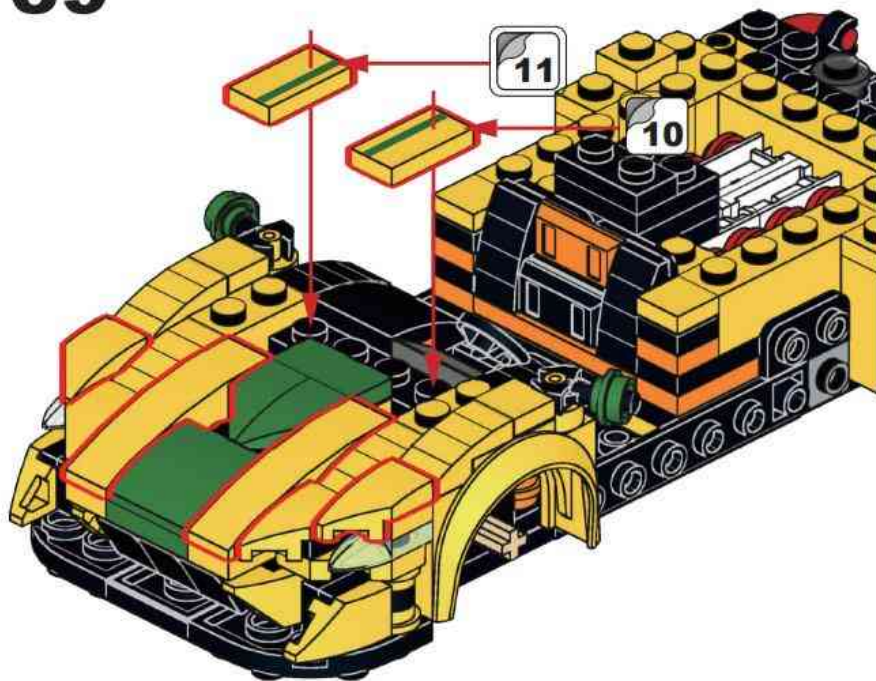

40

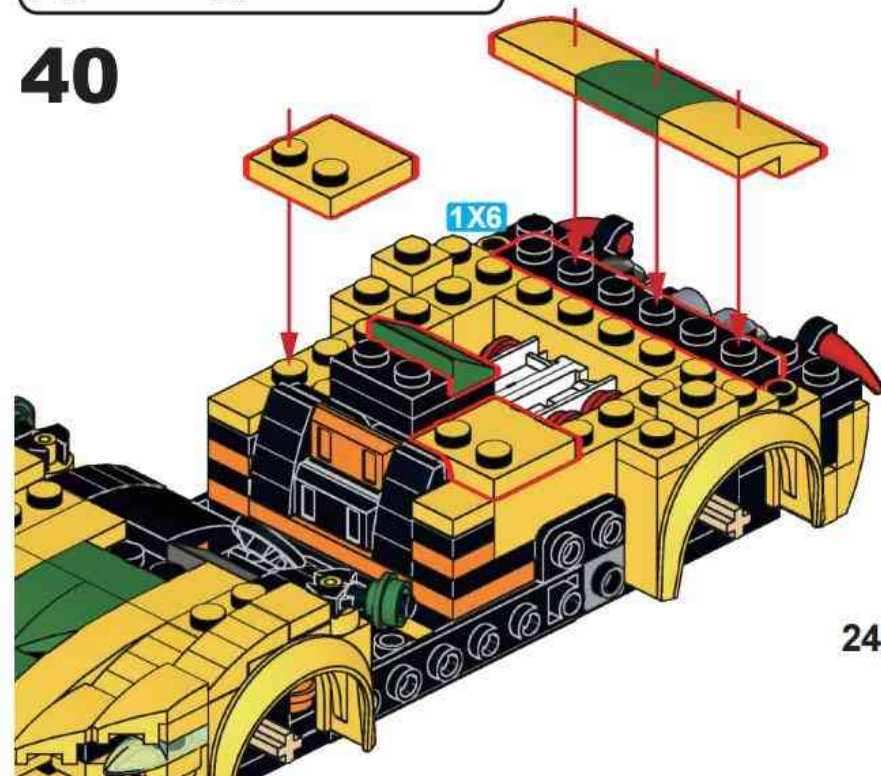

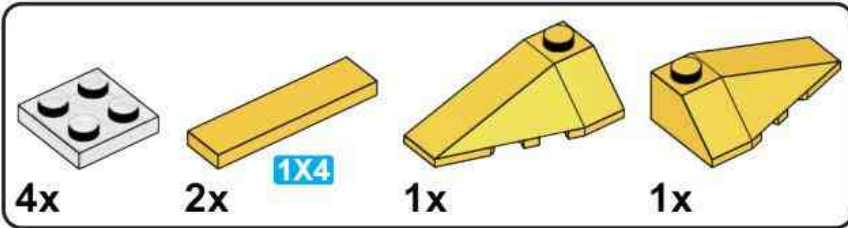

41

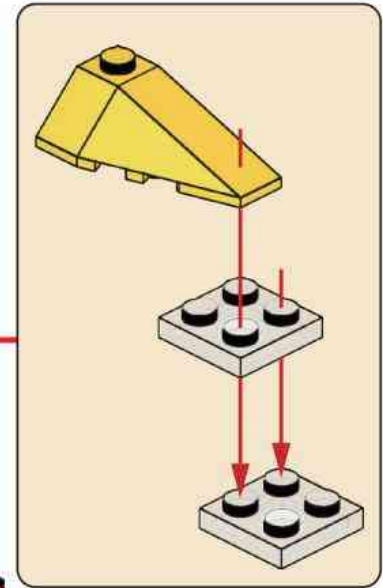
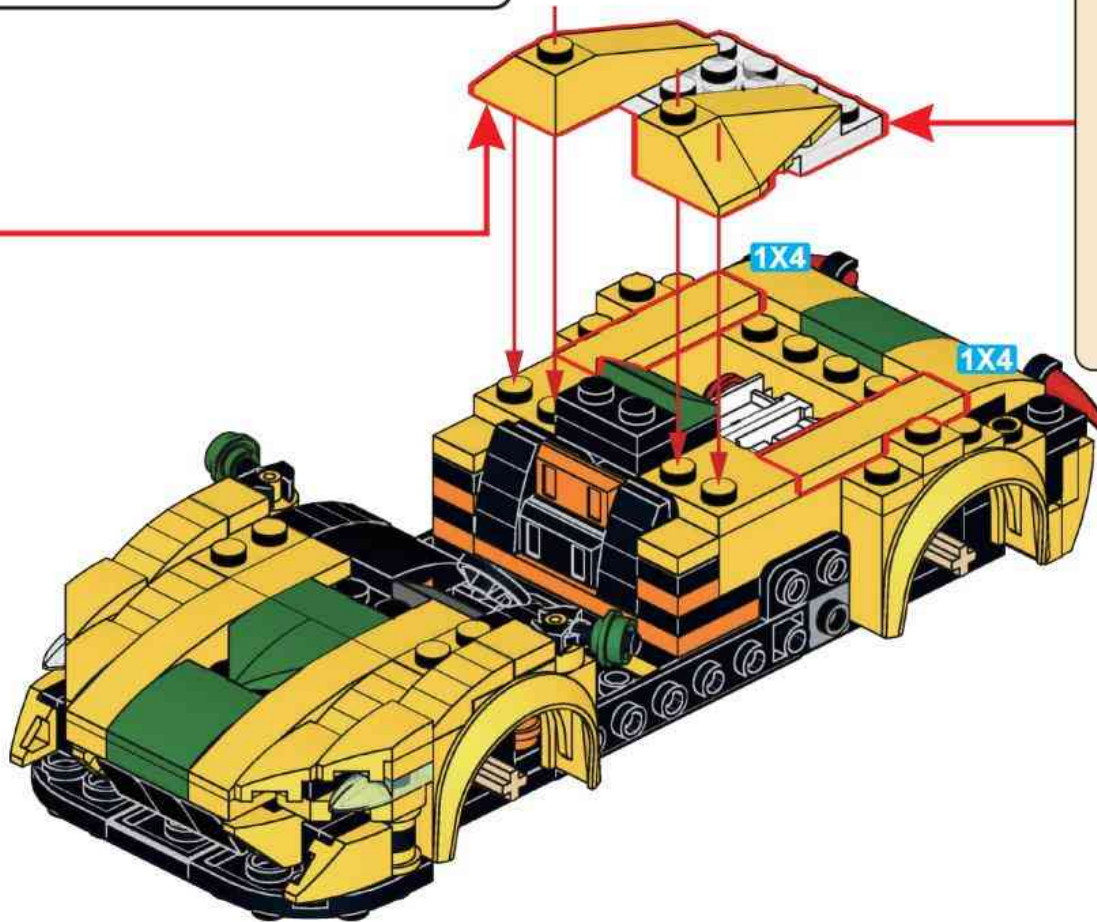
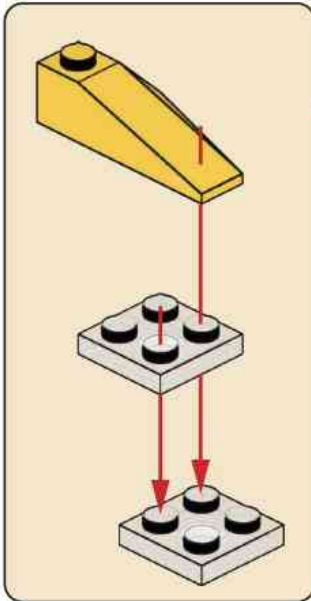

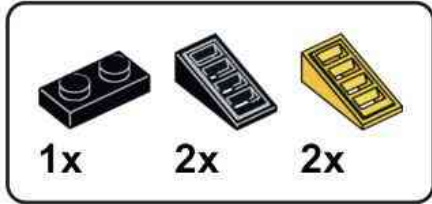

42

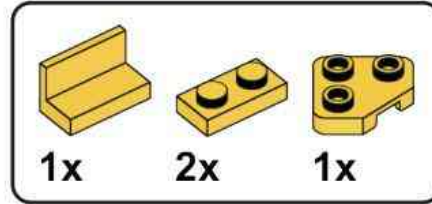
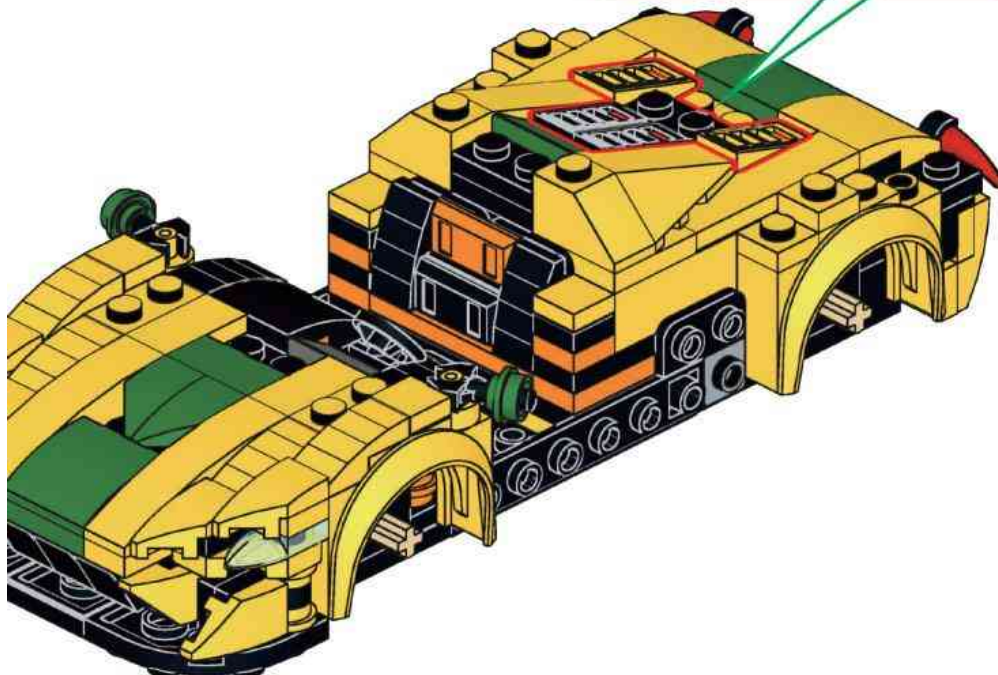
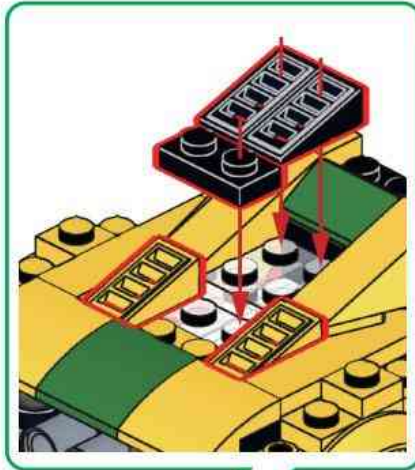

43

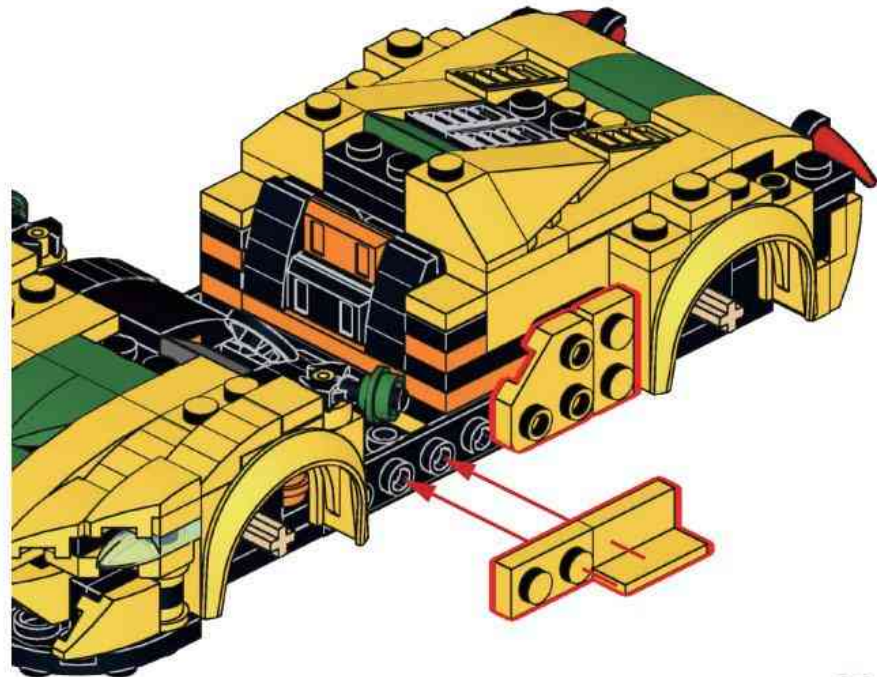

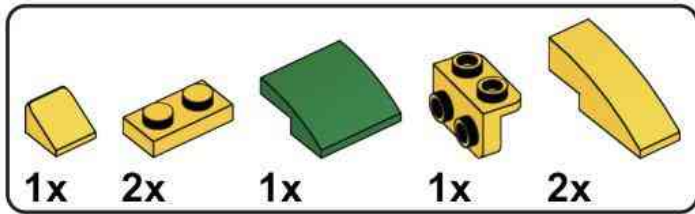

44

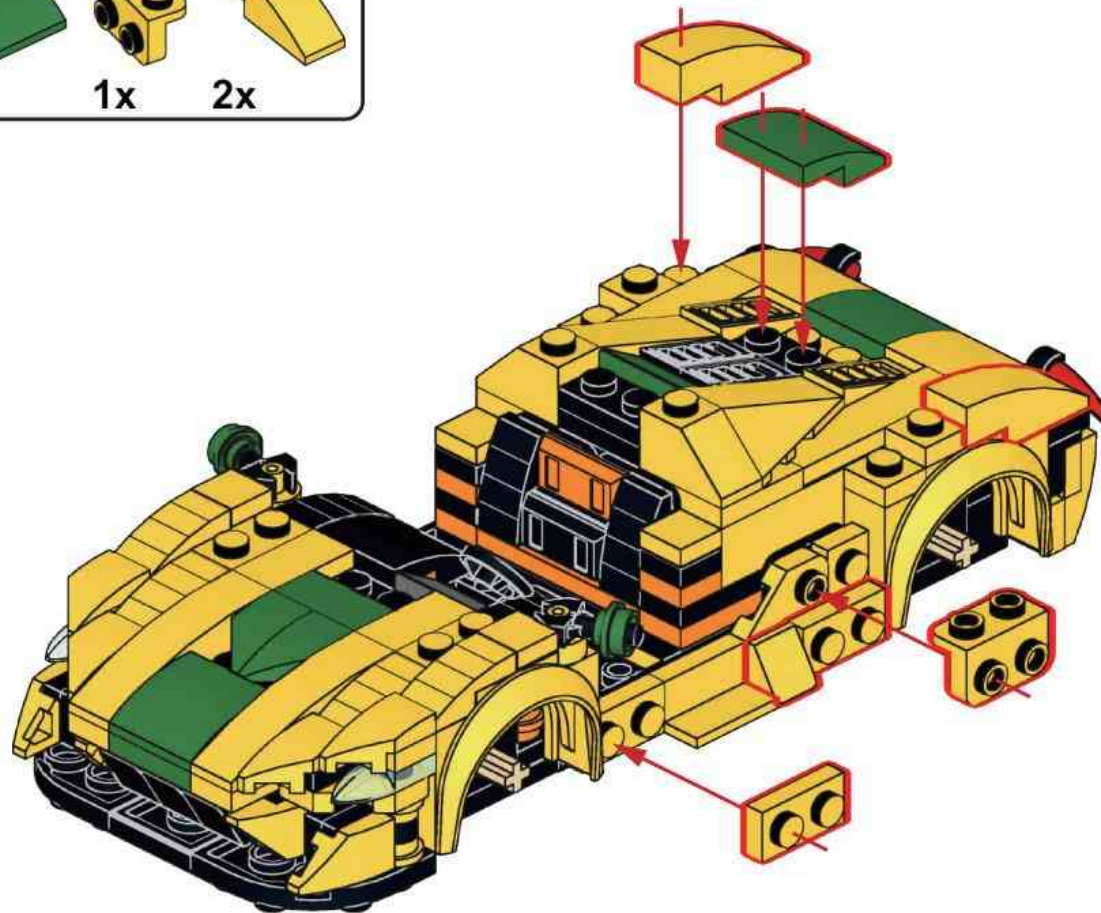

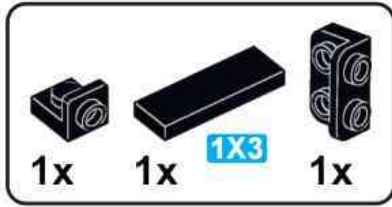

45

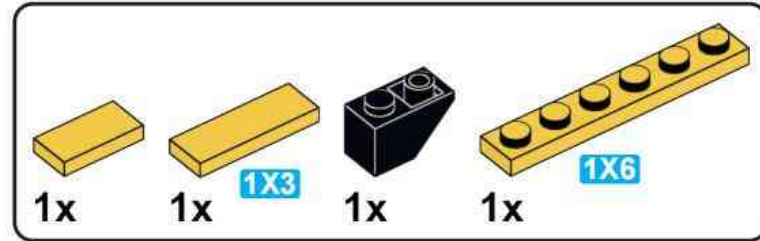
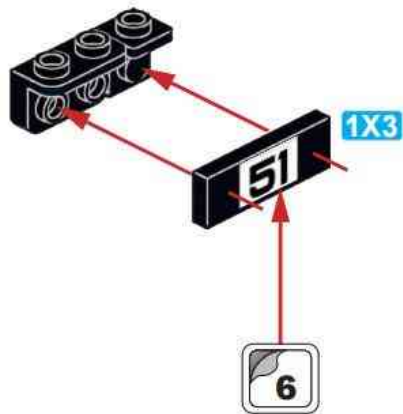

46

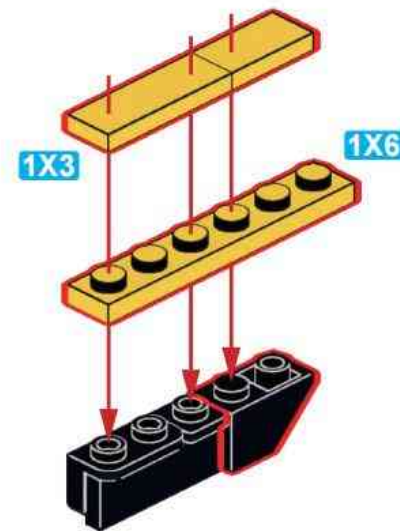

47

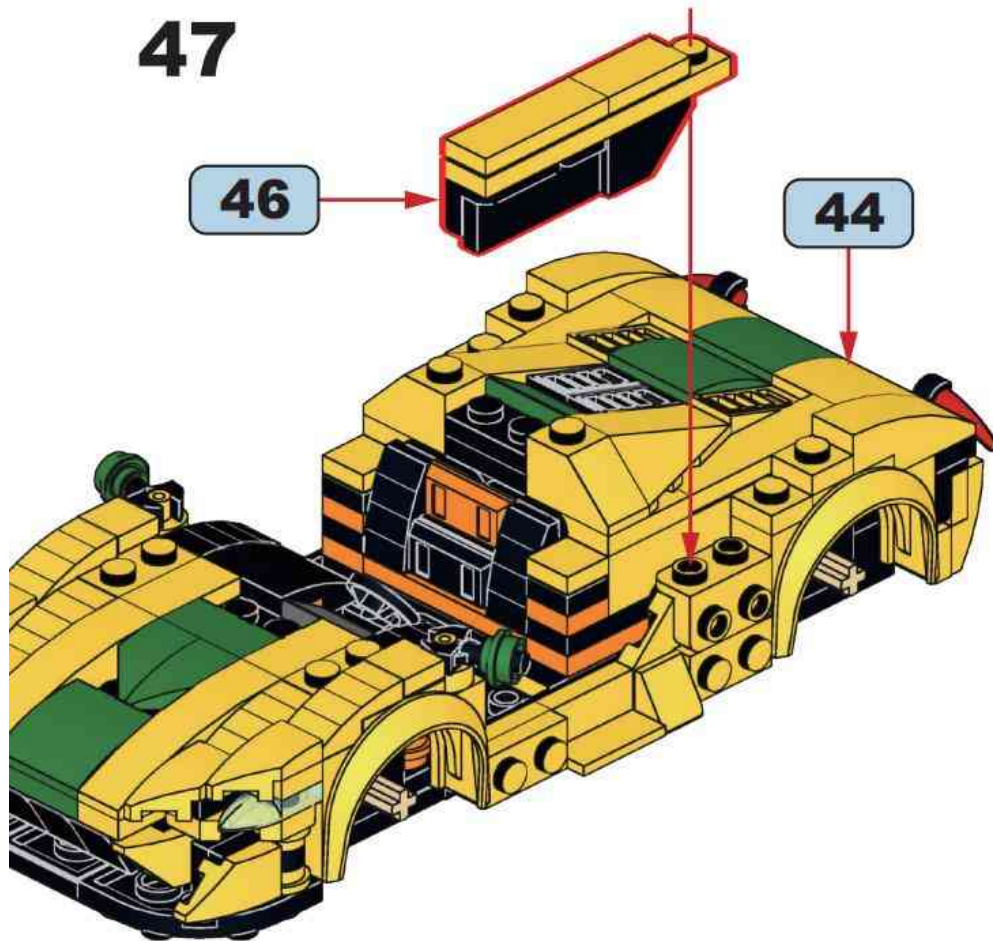

29

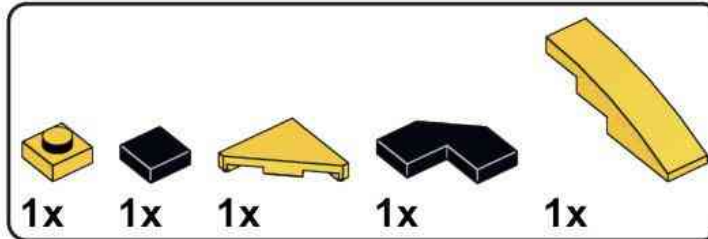

48

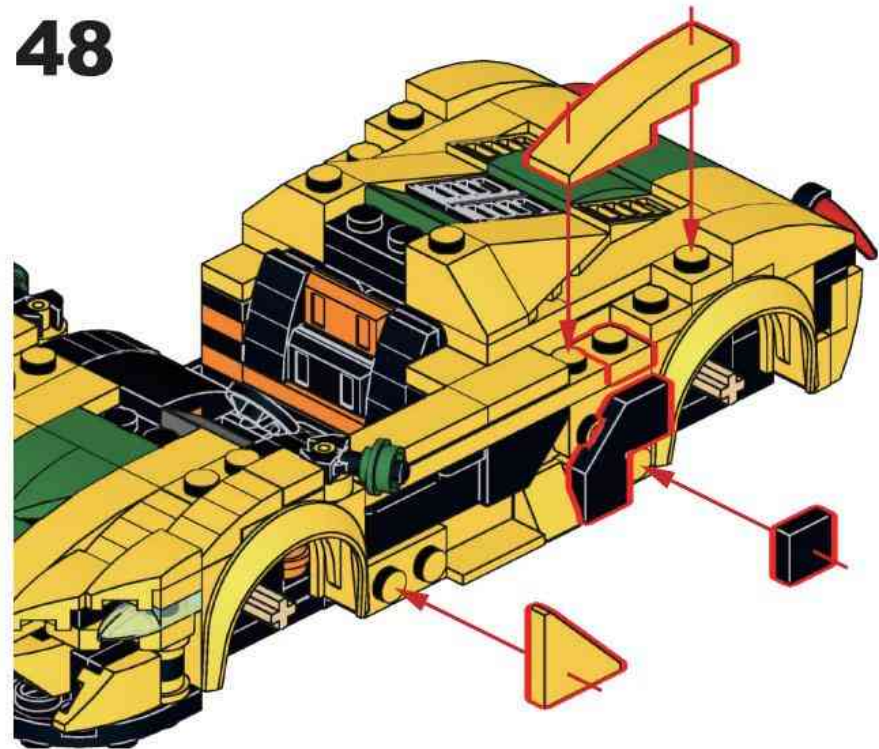

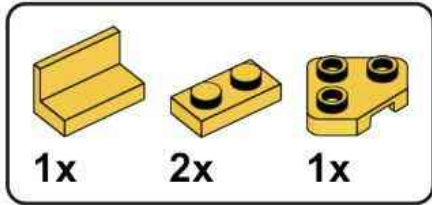

49

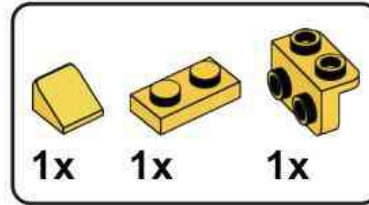
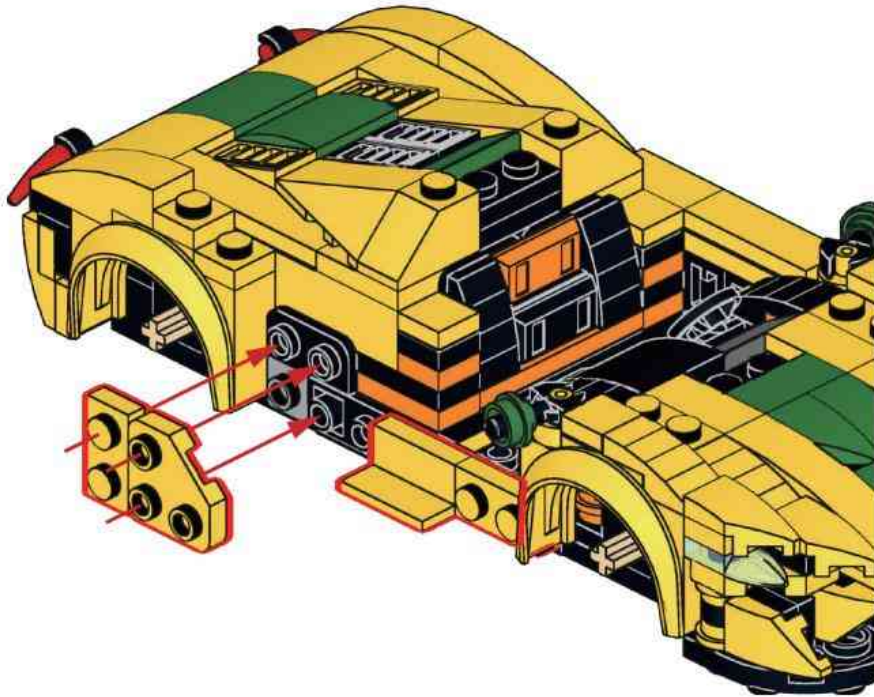

50

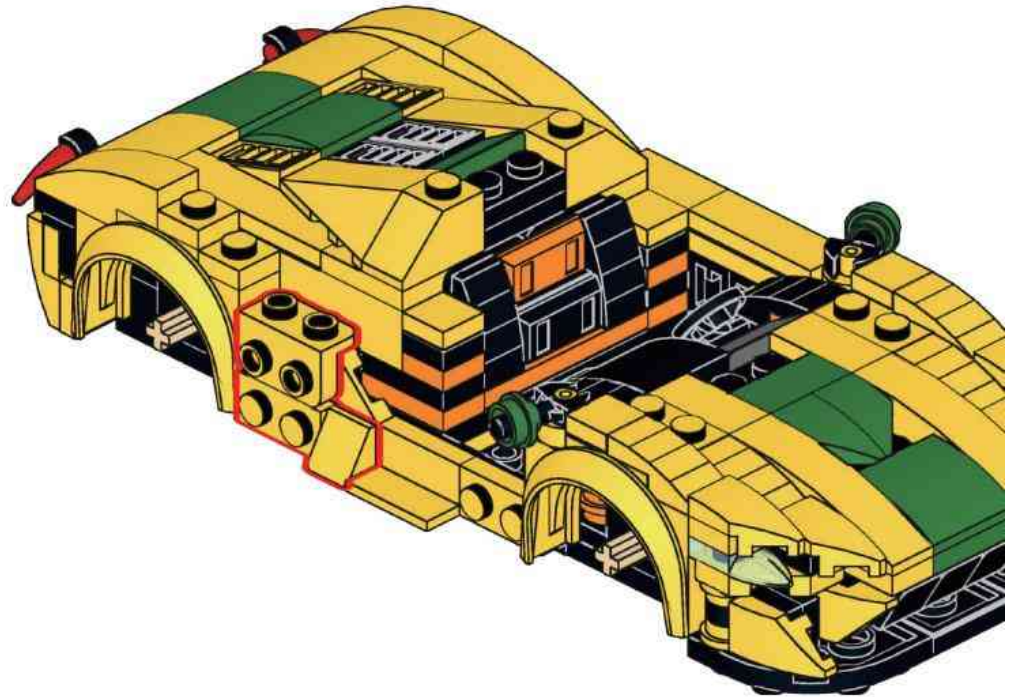

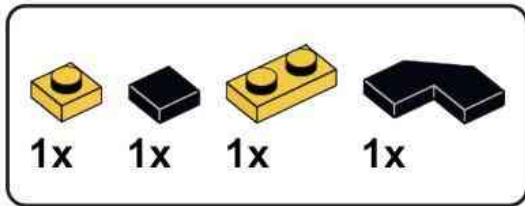

51

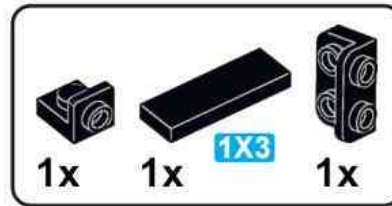
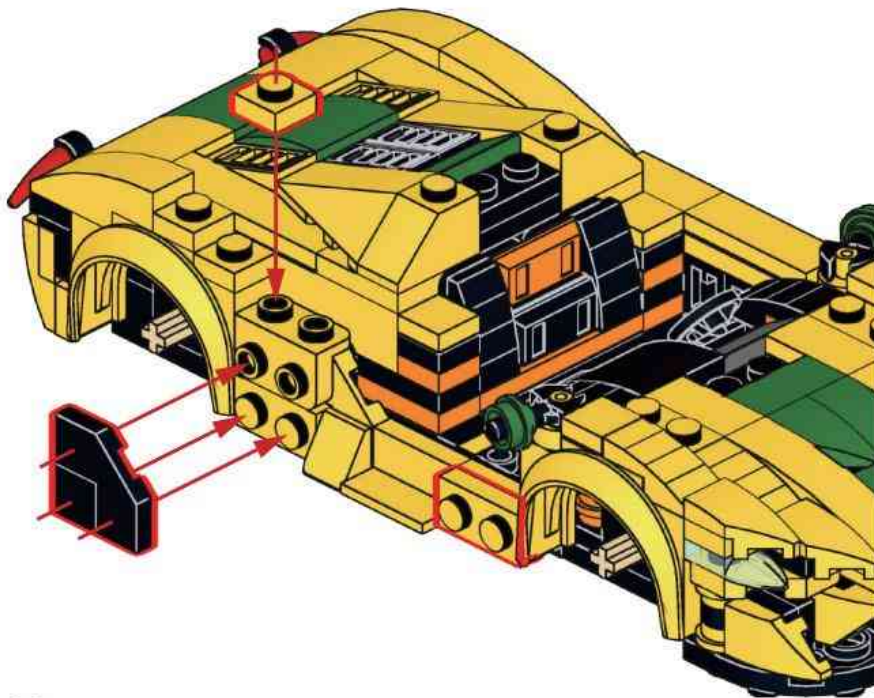

52

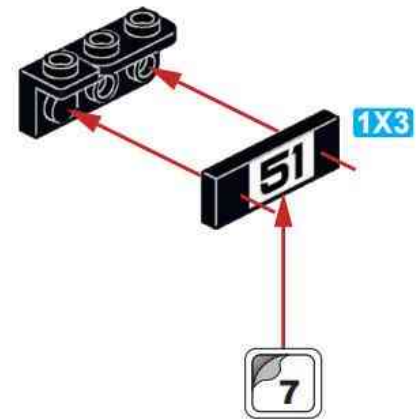

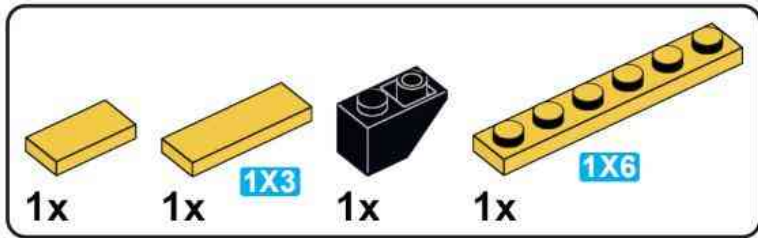

53

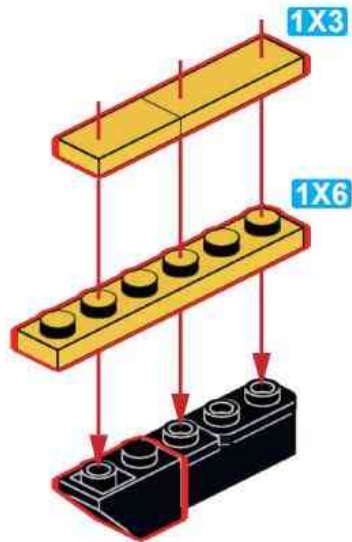

54

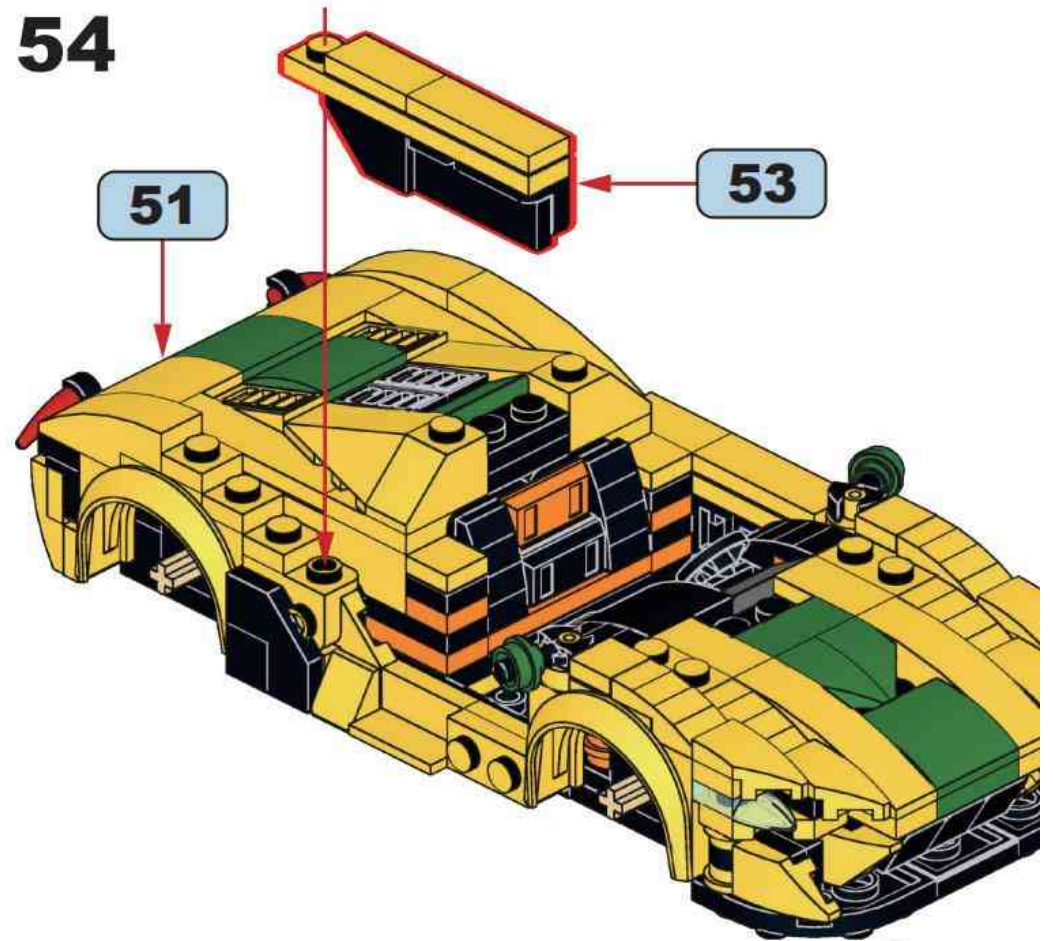

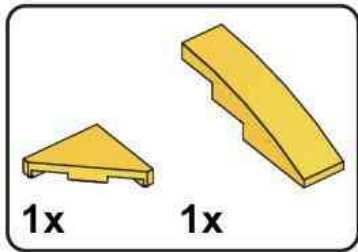

55

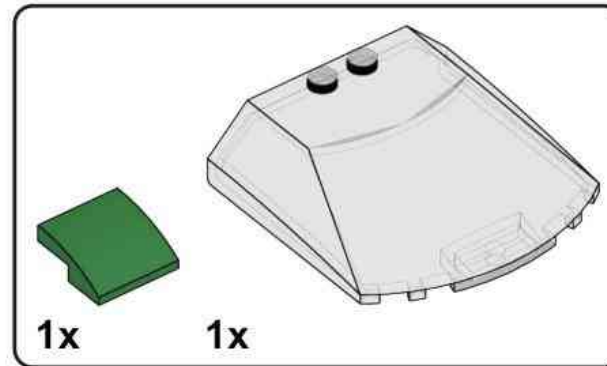
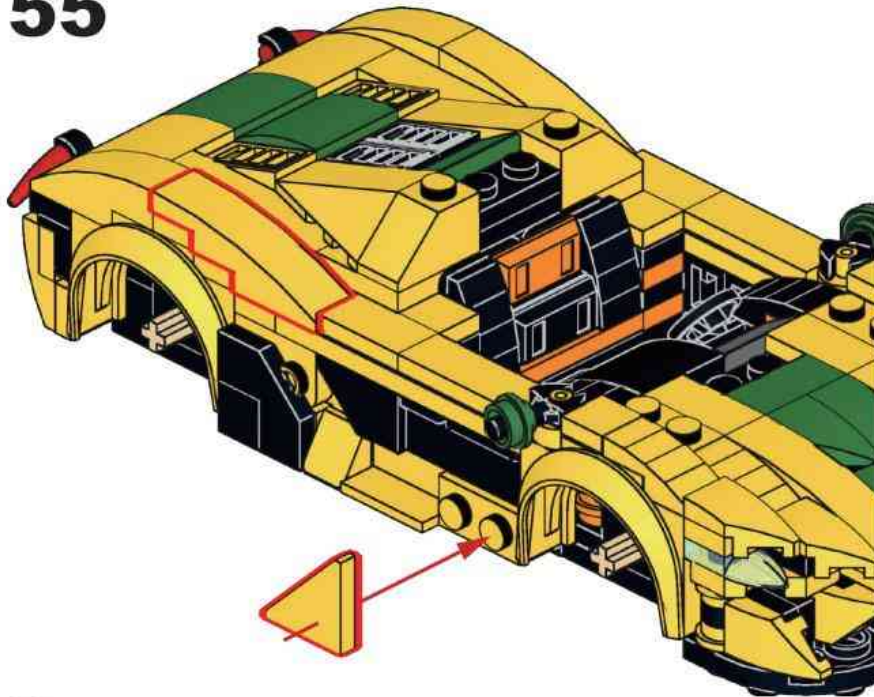

56

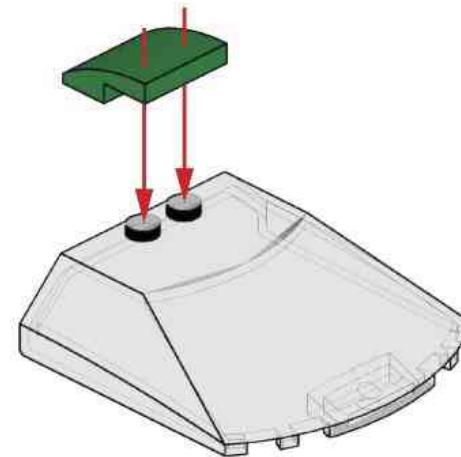

57

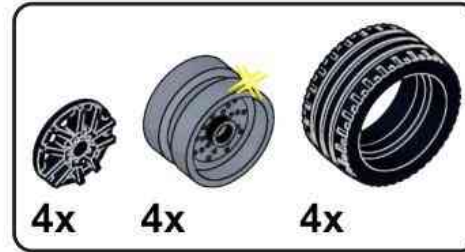
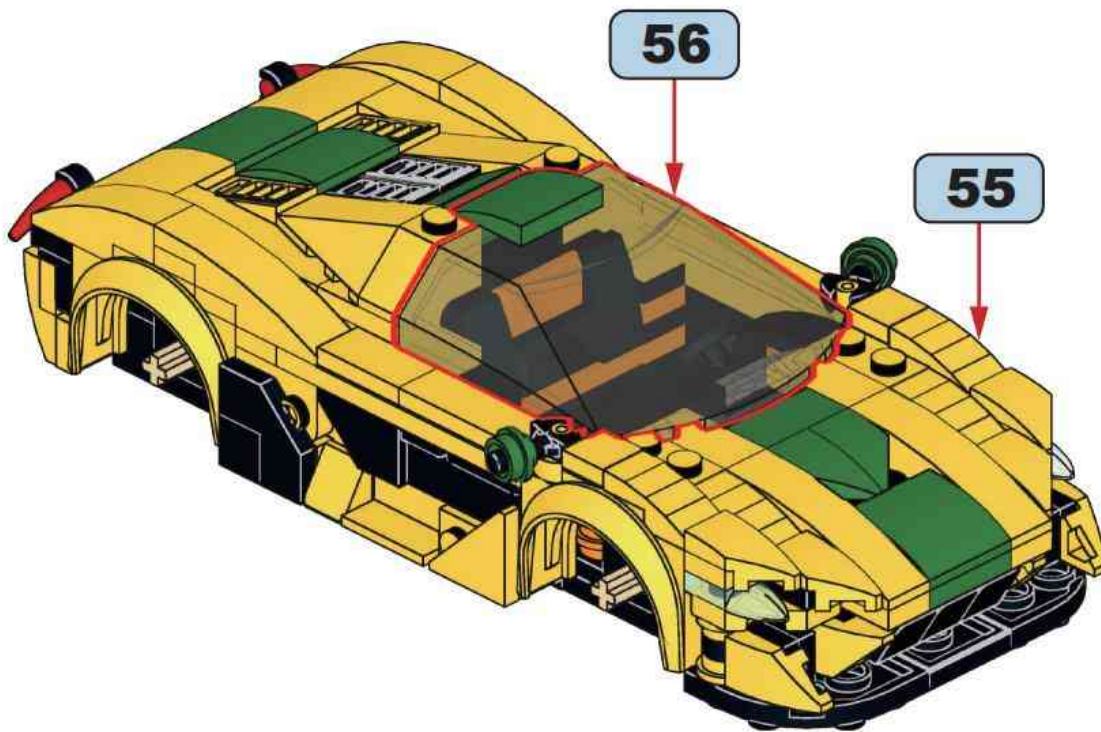

58

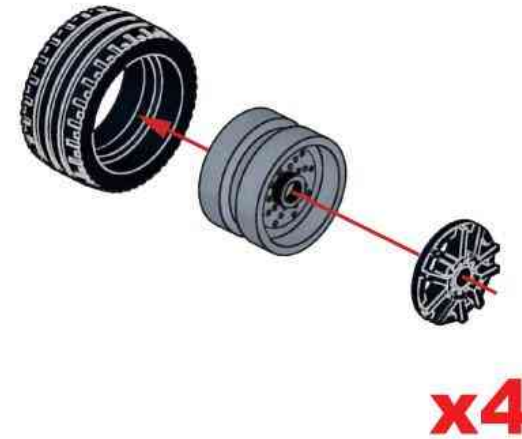

59

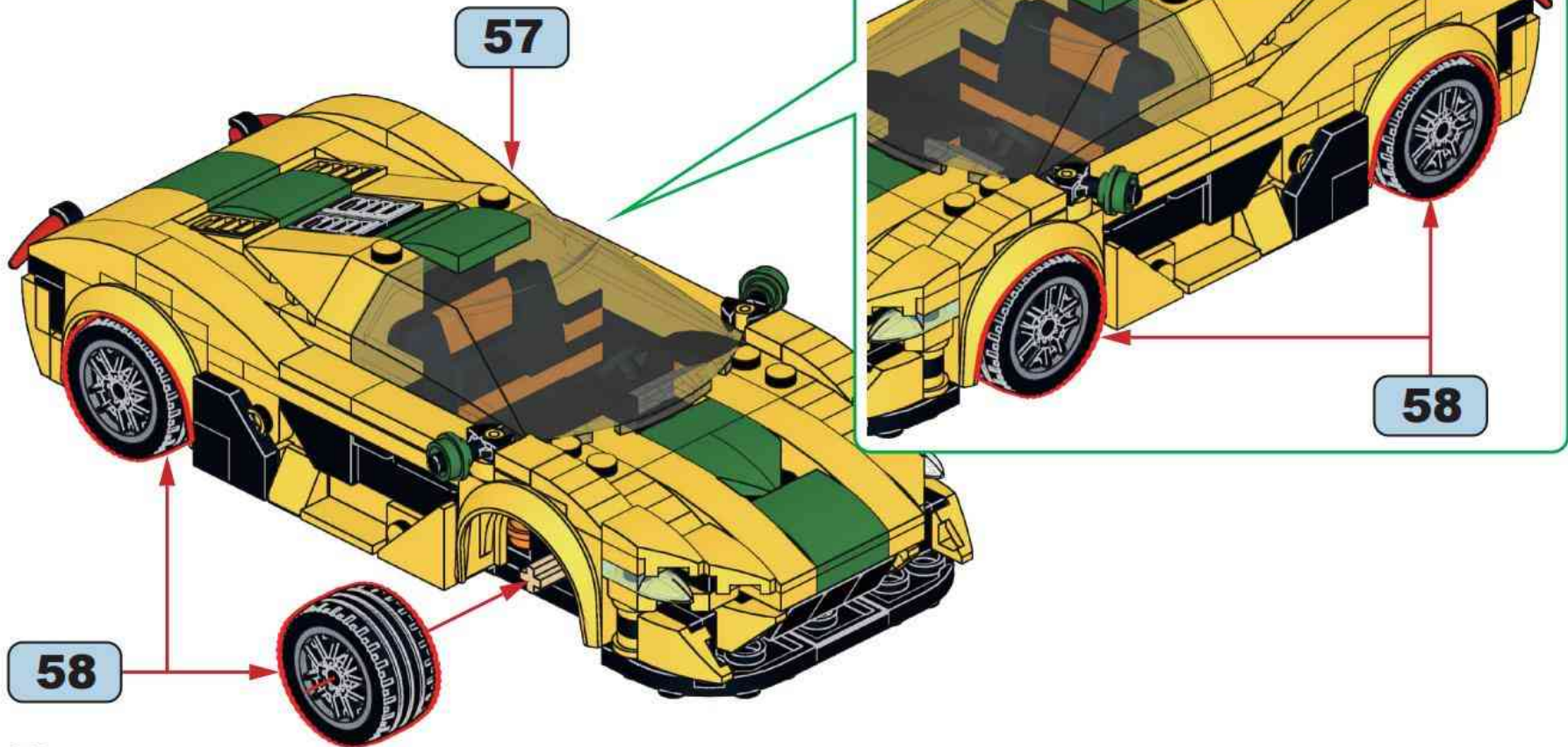

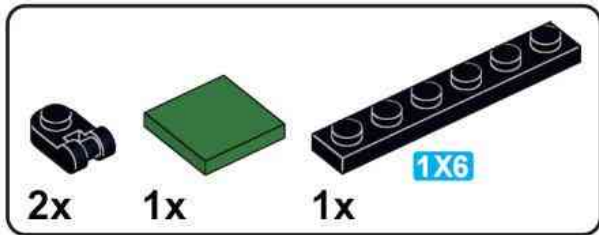

60

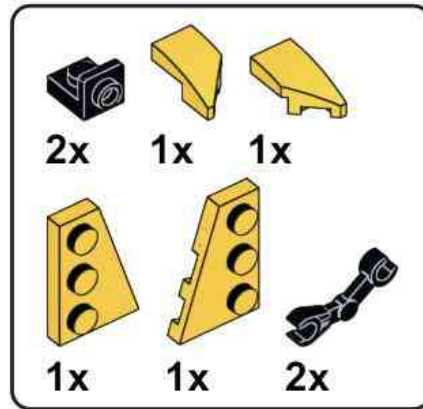
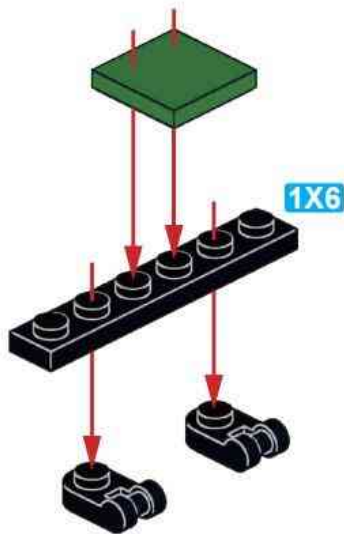

61

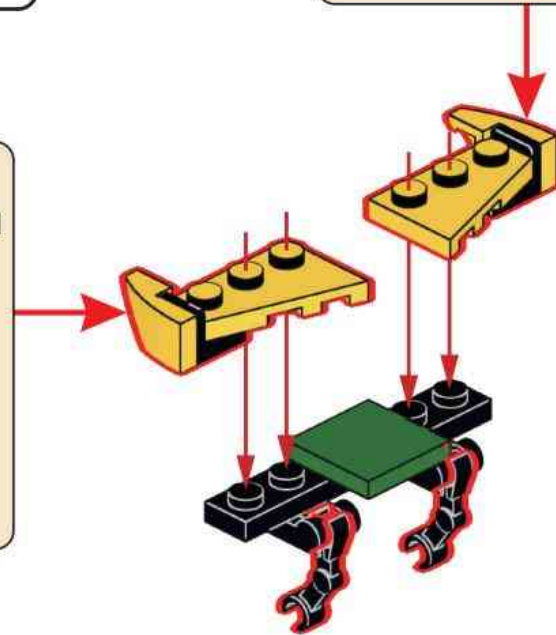
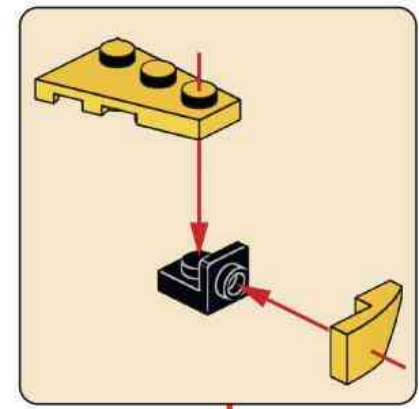
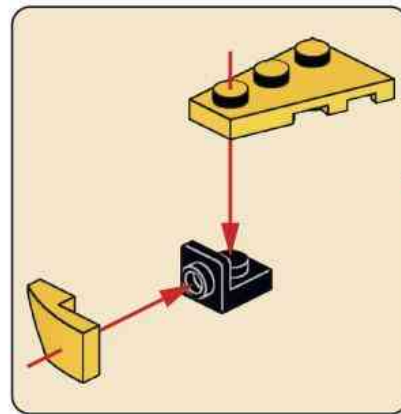

62

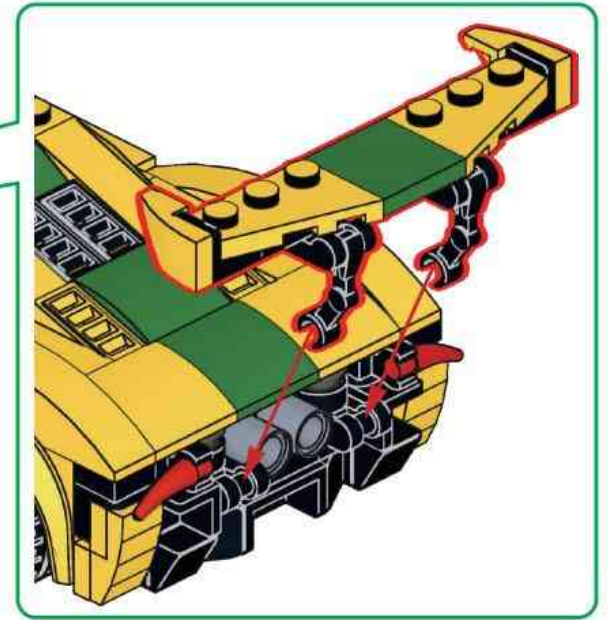
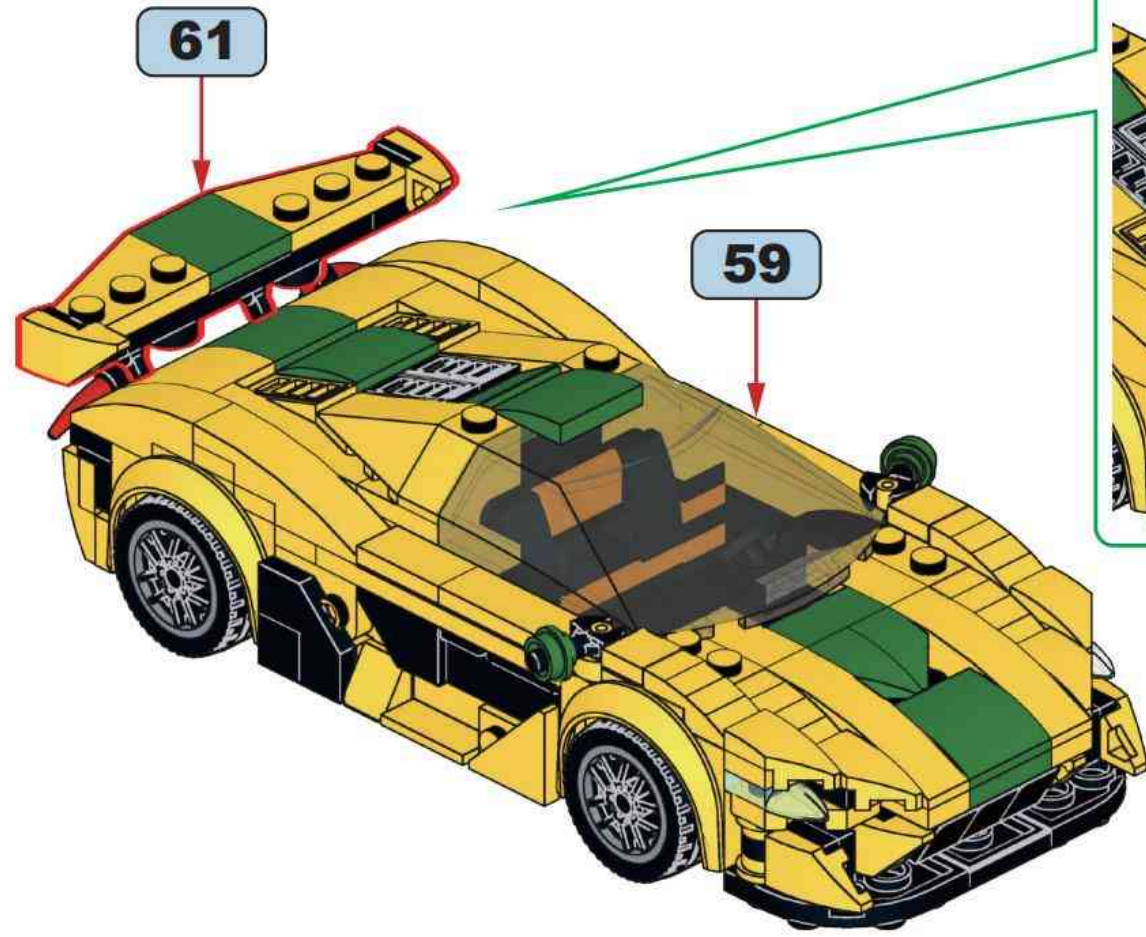

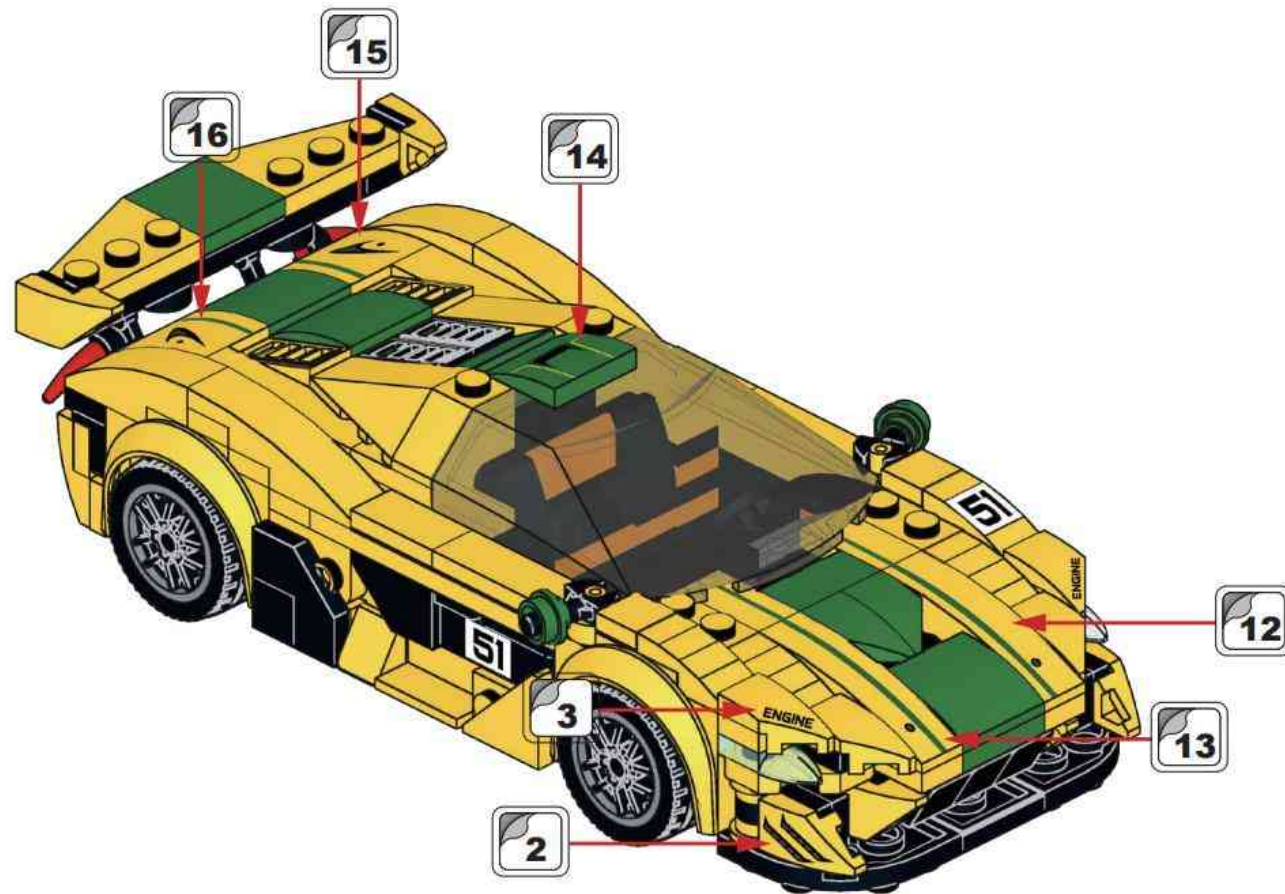

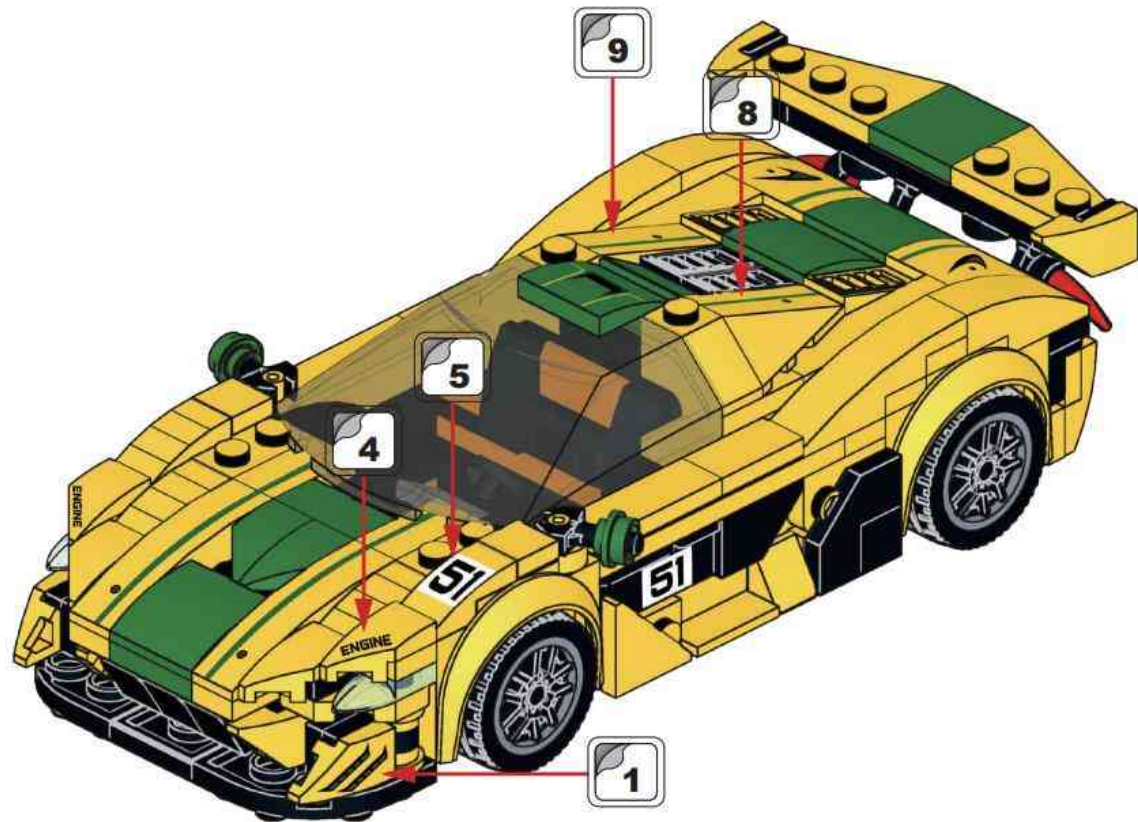





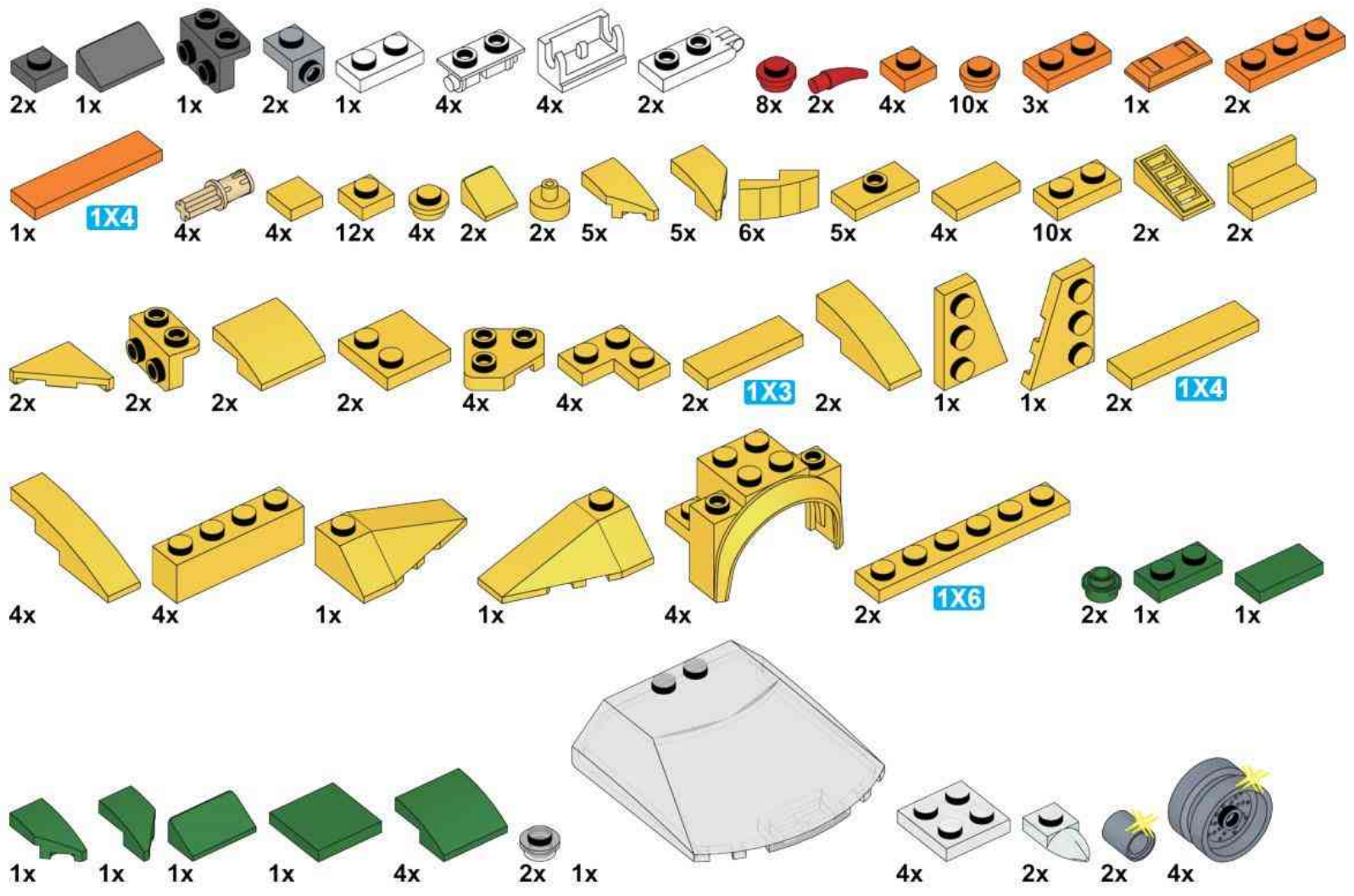



NO.677

TECHNOLOGIE